



SUPER PRECISION BEARINGS

Introduction

As technologies evolve, all manufacturers share a global responsibility to respect and protect the environment. NSK Motion and Control products reflect our corporate commitment to environmental responsibility. While our products improve the performance of machines in a variety of industries, they also save energy and conserve resources because of our superior precision machining technologies.

To meet the needs of the highly specialized machine tool industry, we have enhanced each and every aspect of our R&D capabilities at our Technology Centers. Therefore, NSK's precision bearings are used in a wide variety of industries, such as semiconductor production and industrial robots, and have earned a reputation for excellent performance. Today, NSK manufactures highly accurate, reliable precision bearings in Japan and Europe and supplies them all over the world.

This catalog explains technical materials including our latest research and experimental data, various applications, the types of precision bearings available, and the proper utilization of each specific type of NSK's precision bearing.

MOTION & CONTROL™
NSK

Part1. NSK Super Precision Bearings

Global Support Capabilities	P6
Development Capabilities	P8
Quality Control and Production Capabilities	P10

Part2. Features of Precision Bearings

Metallurgical Technology to Extend Bearing Life	P14
Ceramic Rolling Elements	P16
Cages	P18
Bearing Components	P20
Product Range	P22
Performance of Each Bearing Type	P24

Part3. Selecting the Right Bearing is Critical

Bearing Selection	P36
Typical High-Speed Main Shaft Spindle Structures	P38
Other Spindle Structures	P40
Features of Angular Contact Ball Bearings	P42
Features of Cylindrical Roller Bearings	P44

Part4. Bearing Types

1. Angular Contact Ball Bearings	
High Precision Angular Contact Ball Bearings (Standard Series)	P48-60
Features	
Numbering System	
Bearing Tables	
Miniature Series, BSA Series for Ball Screw Support	
79 Series	
70 Series	
72 Series	
Ultra High-Speed Angular Contact Ball Bearings (ROBUST Series)	P62-79
Features	
Numbering System	
Bearing Tables	
BNR19, BER19 Series	
BNR10, BER10 Series	
BNR19XE/10XE, BER19XE/10XE Series (Spinshot™ II)	
BNR29, BER29 Series (Wide Series)	
BNR20, BER20 Series (Wide Series)	
Ultra High Precision Angular Contact Ball Bearings (ROBUST Series-BGR)	P80-84
Features	
Numbering System	
Bearing Tables	
BGR19 Series	
BGR10 Series	
BGR02 Series	
2. Cylindrical Roller Bearings	
Cylindrical Roller Bearings	P88-97
Features	
Numbering System	
Bearing Tables	
Double-Row Cylindrical Roller Bearings (High Rigidity Series)	
30 Series	
39 Series	
49 Series	
Single-Row Cylindrical Roller Bearings (Standard Series)	
10 Series	
Ultra High-Speed Single-Row Cylindrical Roller Bearings (ROBUST Series)	
10 Series	
Double-Row Cylindrical Roller Bearings (Low Heat Generation Series)	
30 Series	
Ultra High-Speed Single-Row Cylindrical Roller Bearings (Low Heat Generation Series)	
10 Series	
3. Angular Contact Thrust Ball Bearings	
Angular Contact Thrust Ball Bearings	P100-105
Features	
Numbering System	
Bearing Tables	
High-Speed Angular Contact Thrust Ball Bearings (ROBUST Series)	
BAR10 Series	
BTR10 Series	
Double-Direction Angular Contact Thrust Ball Bearings (TAC Series)	
TAC29D Series	
TAC20D Series	
4. Ball Screw Support Bearings	
Angular Contact Thrust Ball Bearings for Ball Screw Support	P108-113
Features	
Numbering System	
Bearing Tables	
Machine Tool Applications	
TAC B Series	
Electric Injection Molding Machine Applications	
TAC02 and 03 Series	
Units for Ball Screw Support	P114-115
Features	
Numbering System	
Bearing Tables	

5. Precision Deep Groove Ball Bearings

Precision Deep Groove Ball Bearings	P118-120
Features	
Numbering System	
Bearing Tables	
T1X Type (Polyamide resin cage)	
60, 62 and 63 Series	

6. Peripheral Equipment

Gauges	P124-127
GR Gauges	
Features	
Numbering System	
GTR Gauges	
Features	
Numbering System	
GN Gauges	
Features	
Numbering System	
Bearing Monitor	P128
Bearing Heater	P129
Grease Replenishing System	P130-131
Oil-Air Lubricator	P132-133
Sealed Precision Spacers for Machine Tool Spindles	P134-135

Part5. Technical Guide

1. Life	P138-145
· Rolling Fatigue Life and Basic Load Rating	
· New Life Theory	
2. Static Load Ratings and Static Equivalent Loads	P146-147
3. Angular Contact Ball Bearing Combinations	P148-151
· Features of Each Combination	
· Universal Combination	
4. Preload and Rigidity	P152-169
· Types of Preload and Rigidity	
· Preload and Rigidity Tables	
5. Limiting Speeds	P170-171
6. Lubrication	P172-175
7. Bearing Tolerances	P176-183
· Tolerance for Radial Bearings	
· Tolerances for Tapered Bores	
· Tolerances for Angular Contact Thrust Ball Bearings	
8. Designing of Shafts and Housings	P184-188
· Fitting of Shafts and Housings	
· Shafts and Housing Tolerance	
· Shoulder and Fillet Dimensions	
· Chamfer Dimensions	
9. Spacers	P189-193
· Spacer Dimensions	
· Position of Spray Nozzle	

Part6. Bearing Handling

1. Mounting	P196-209
1. Cleaning the Bearings and Related Parts	
2. Checking Dimensions of Related Parts	
3. Mounting Procedures	
4. Inspection after Mounting	
2. Operational Inspection	P210-211
3. Initial Running-in Procedures	P212-213

Part7. Bearing Failure Diagnosis

1. Bearing Failure and Measure	P216-219
2. Diagnosis with Sound and Vibration	P220-225

Part8. Appendices

Tolerances for Shaft Diameters	P228-229
Tolerances for Housing Bore Diameters	P230-231
Values of Standard Tolerances for IT Grades	P232-233
Hardness Conversion Table	P234
Physical and Mechanical Properties of Material	P235-236
Old and New Number Contrast Table	P237
Method for Measuring Axial Clearance of Combined Angular Contact Ball Bearings	P238
Request for Specification Investigation	P240

SUPER PRECISION BEARINGS

Part 1

Contents

Part1. NSK Super Precision Bearings

Global Support Capabilities ————— P6

Development Capabilities ————— P8

Quality Control and Production Capabilities ——— P10



Uniform support system anywhere in the world

NSK is committed to manufacturing and selling products with consistently high quality anywhere in the world under the leadership of Technology Centers in the four major global markets. NSK's sales offices, with expert staff that constantly explore customer needs, promote global network management that encompasses Technology Centers as well as production sites.

NSK can respond quickly and effectively to the various needs of customers and supports their business development efforts in any region.

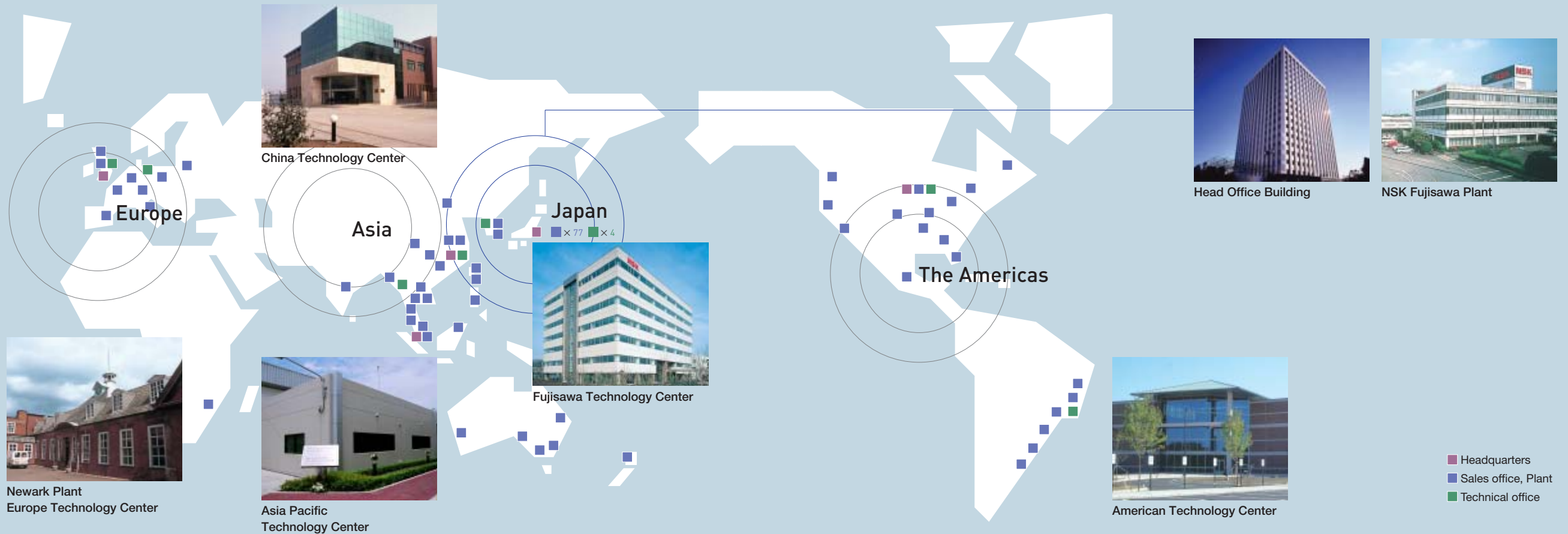

Global network management provides optimal, high-quality products

NSK has established a highly-developed information network centered on Technology Centers located in the four major markets of the world—Europe, the United States, Asia and Japan. With this network, we are able to gather information, in real time, related to the changes and trends in any market in the world. As a result, we can react quickly to meet changing customer needs to supply optimal, high-quality products.



Information system directly linked to customers

Technology Center customer support

Technology Centers in four major markets provide technical support to customers in their respective regions. This support enables our customers to use NSK's products under ideal conditions and achieve the best possible performance.



Custom products for unique customer applications

Each Technology Center works closely with our customers to determine their precise application needs. In doing so, we assist them in identifying the right NSK product for each application to realize maximum efficiency and cost effectiveness. Upon request, we can also supply completely customized products to satisfy highly-specialized customer needs.

Our global support network is available wherever our customers are located

Our extensive global network is able to receive orders and supply products anywhere in the world. NSK's distributors cover the globe and maintain an inventory of all critical products in every major market and location, making it possible to supply products to customers without delay. NSK also provides technical support worldwide to help customers determine the best bearing for each application, respond quickly to any questions, and immediately address any problems our customers may encounter.



<http://www.nsk.com>

NSK's key technology

NSK's key technology is Tribology, the science of friction and wear.

Tribology is a technology that focuses on saving energy and conserving resources by reducing friction and wear as well as preventing machine failure and thereby increasing reliability.

With tribology positioned at its core, NSK will further expand its four key technologies: analysis technology for thoroughly eliminating energy losses; evaluation technology for ensuring exacting responsiveness to market needs; lubrication technology for reducing energy losses and enhancing functionality; and material technology for extending product life, and will forge ahead in the development of environmentally friendly products based on the foundation of these technologies.

Analysis Technology

NSK developed its own software, BRAIN (Bearing Analysis In NSK), which enables digital simulations of friction-related movement and performance by applying Tribology. The combined use of this simulation data with an effective factor method (EFM) realizes advanced computer-aided engineering (CAE).

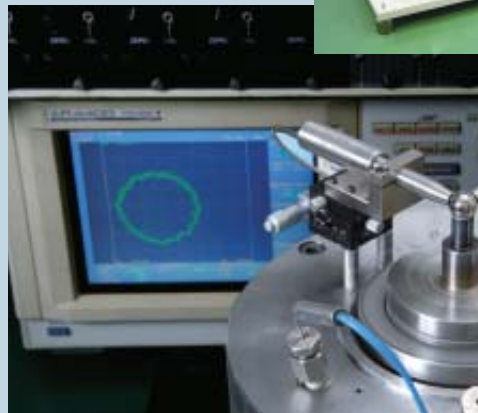
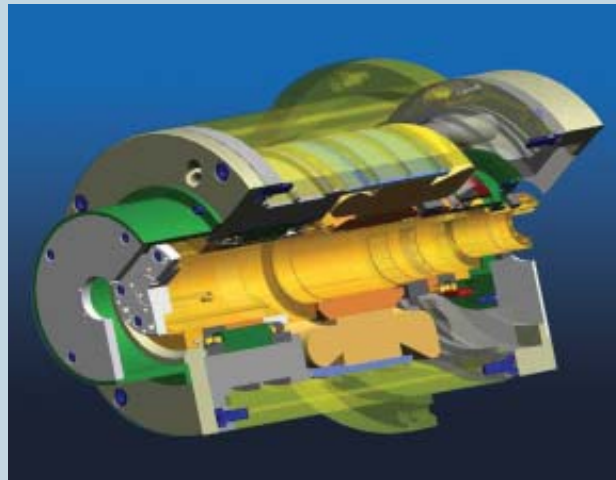

Evaluation Technology

NSK has established an evaluation technology that spans a wide range of applications by employing advanced technologies such as nano-order runout measurement using ultra high-precision measuring instruments. Our evaluation technology contributes to the development of cutting-edge products that correspond with increasingly sophisticated market needs.

Lubrication Technology

Through the relentless application of Tribology, NSK's key technology, NSK has pursued lubrication technologies that allow machines to deliver maximum performance and NSK's accomplishments in these efforts contribute to saving energy and resources, thereby conserving the global environment.



Material Technology

Research and development across a wide range of material technologies has been conducted to produce ever-higher performing products. Products made of NSK's proprietary materials deliver long life under harsh conditions, are maintenance-free, and also support all industries.

The highest level of quality in the world

NSK precision bearings deliver the highest level of accuracy, supported by our production capability, state-of-the-art equipment and extensive manufacturing expertise, as well as our commitment to applying the same rigorous quality control procedures at each stage of the production process in every NSK facility.

NSK focuses its efforts at its global production sites in Japan and England on offering products with high accuracy to quickly meet the diverse needs of customers worldwide.

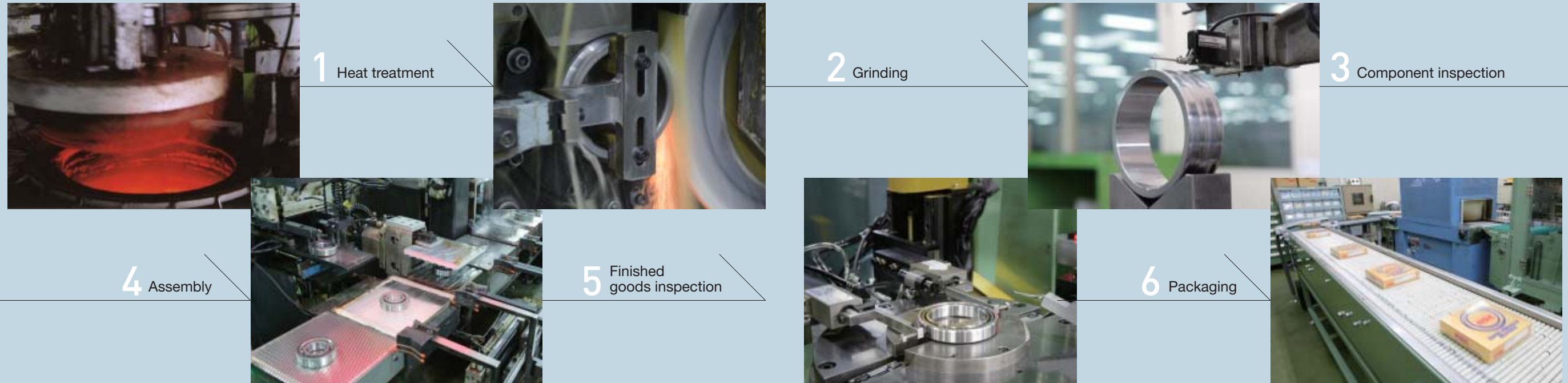

Manufacturing technologies to produce high accuracy products

To maintain our reputation for manufacturing precision bearings with the highest degree of accuracy in the world, all precision bearings are checked to nanometer accuracy.



Global production in England and Japan

NSK's precision bearings are made in both England and Japan. The combined expertise and locations of these manufacturing facilities allow us to meet every customer need.



NSK Newark Plant



NSK Fujisawa Plant

NSK symbol

NSK's golden box guarantees the highest level of accuracy.



Complete quality control and environmental responsibility

As members of an ISO 9001-certified enterprise, all NSK plants adhere to strict international standards for quality control. NSK is also making an all-out, companywide effort to address environmental concerns as a top priority.



ISO 9001 Certification

ISO 14001 Certification

High Performance in the Next Generation

NSK continually challenges the status quo to explore new possibilities. As our design philosophy does not allow us to compromise quality in manufacturing, we are driven to develop total solution technologies.

By using the latest material and analysis technologies we are able to design and manufacture exceptional, high performance precision bearings.

NSK will always strive to achieve the quality and performance that will be required in next generation bearings.

Contents

Part2. Features of Precision Bearings

- Metallurgical Technologies to Extend Bearing Life — P14
- Ceramic Rolling Elements — P16
- Cages — P18
- Bearing Components — P20
- Product Range — P22
- Performance of Each Bearing Type — P24



Three types of steel materials support the long life and high performance of NSK super-precision bearings

NSK has established groundbreaking evaluation techniques for inclusions in steel and steel-making procedures. These technologies make it possible to develop materials for long-life, high-performance rolling bearings.

Three types of steel materials—SHX steel that withstands ultra high-speed rotation environments, EP steel that exhibits high reliability under heavy load environments, and Z steel that achieves extended operation life under general conditions—support NSK super-precision bearings.

Z Steel as a Standard Material for Super-Precision Bearings

Z Steel Standard Long Life Material
1.8 Times Longer Fatigue Life than Conventional Vacuum Degassed Steel

It is well known that the rolling fatigue life of high carbon chrome bearing steel (SAE52100, SUJ2) used for rolling bearings is significantly affected by non-metallic inclusions. Life tests show that oxide non-metallic inclusions exert a particularly adverse affect on rolling fatigue life. Z Steel, with lower oxide non-metallic inclusions, exhibits improved performance.

Features of Z Steel

Z Steel is produced by reducing non-metallic inclusions, oxides and other inclusions such as Ti, or S, inside the steel. Bearings made of this steel deliver significantly extended service life, up to 1.8 times longer, compared to conventional vacuum degassed steel.

Oxygen Content in Steel and Operating Life

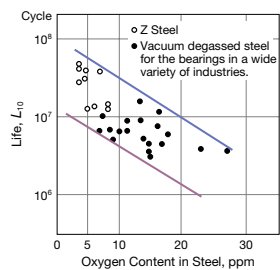

Products made of Z Steel



NSK uses Z Steel as a standard material

EP Steel for Higher Reliability under Heavy Load Environments

EP Steel Extra Long Life and High Reliability
3 Times Longer Fatigue Life than SUJ2 Steel

Development of innovative techniques for evaluating oxide non-metallic inclusions and the establishment of steel-making procedures resulted in EP steel that achieved a dramatic advance in bearing reliability.

Features of EP Steel

Bearings made from EP Steel exhibit increased reliability due to minimal variation in life resulting from the new evaluation technique and significantly reduced impurities.

The establishment of a new evaluation technique

NSK established the NSK-ISD2 Method, an image analysis system and a special steel-making procedure, to improve the evaluation of oxide non-metallic inclusions.

Improvement of steel-making procedures

The introduction of this technique into steel manufacturing technology significantly improved purity and reduced non-metallic inclusions compared to Z Steel. EP Steel contains fewer large particles than either Vacuum Arc Remelted (VAR) or conventionally refined Z Steel.

Purity comparison through image analysis

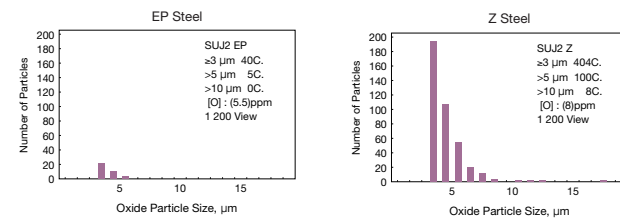

Fatigue Life Subsurface originated flaking test

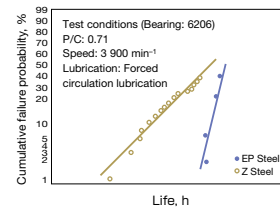

Products made of EP steel



Ball Screw Support Bearings

SHX Steel Endures Ultra Speed Rotation Environments

SHX Steel Heat Resistant Steel Extends the Life of Bearings Used in Ultra High-Speed Applications
4 Times Longer Fatigue Life than SUJ2 Steel, at 20% Higher Speed

SHX is a heat-resistant steel resulting from NSK's special heat treatment technology.

Features of SHX Steel

SHX steel exhibits similar heat resistant performance to M50 steel, which is used for bearings on the main shaft of jet engine applications where temperatures reach 300°C, and features lower friction performance, while at the same time exceeding M50 steel in wear and seizure resistance and fatigue life.

This level of heat resistance, lower friction performance and indentation resistance represent ideally suited steel characteristics for ultra high-speed machine tool bearings.

Patent Number: 2961768JP

Wear Resistance

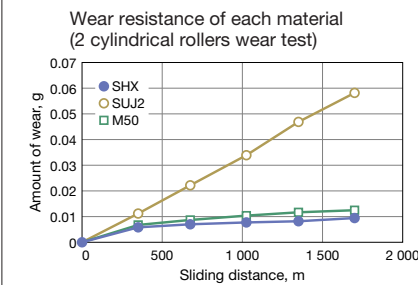

2 cylindrical rollers wear test

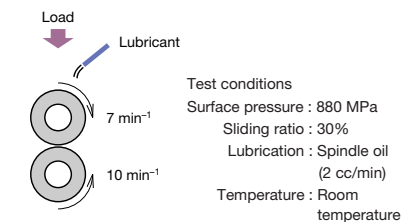

Seizure Resistance

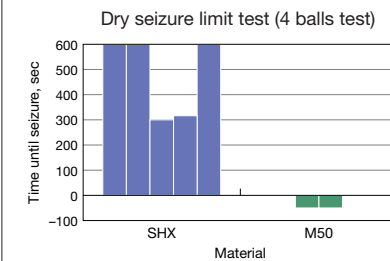

Oil bath seizure limit test (4 balls test)

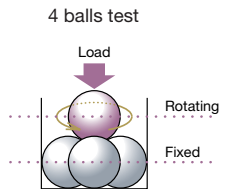
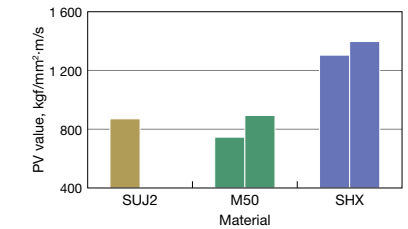

Fatigue Life

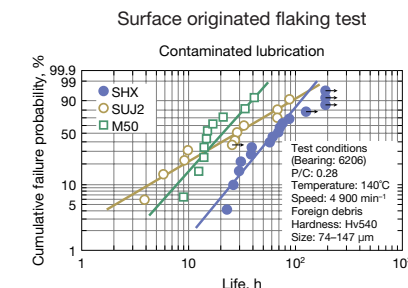
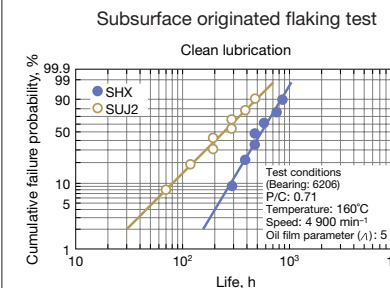

Products made of SHX Steel



Ultra High-Speed ROBUST Series for Ultra High-Speed Machine Tool Main Spindles

Less heat is generated, making possible ultra high-speed rotation.

Ceramic hybrid bearings have many excellent performance characteristics such as heat resistance, extended life, light weight, lower thermal expansion, electrically non-conductive, and thus can be used in an infinite number of applications as a new generation material. Early on NSK's knowledge of materials and bearing manufacturing led us to utilize one ceramic in particular, silicon nitride (Si_3N_4), for the rolling elements in ceramic hybrid bearings. Hybrid bearings with ceramic elements have earned a good reputation in the field for ultra high speed combined with ultra high accuracy, a performance combination that is not achievable in bearings with steel rolling elements.



High speed and low-heat generation

- **Light weight**
As the density is 40% lower than that of steel, the centrifugal force applied to the rolling elements is smaller, thus extending bearing life.
- **Low coefficient of linear expansion**
In applications involving high speed operation, although the temperature of the bearing is high, this low coefficient results in lower preload and lower heat generation.
- **Low friction**
The slip of the rolling element during operation is reduced, and this means less heat is generated.

Less heat is generated, making possible ultra high-speed rotation.

Calculated result of heat generation

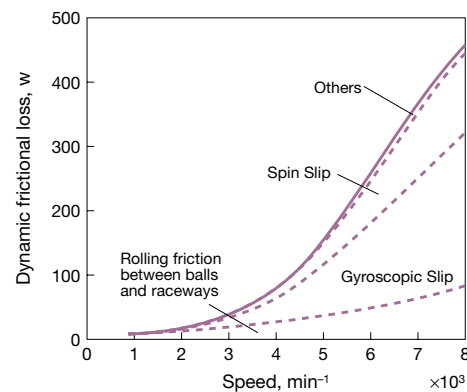
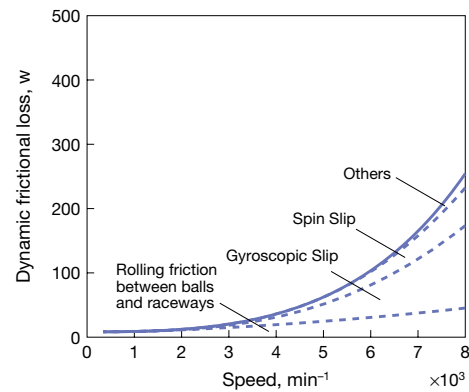

The Outer Ring Temperature Rise in High Speed Operation

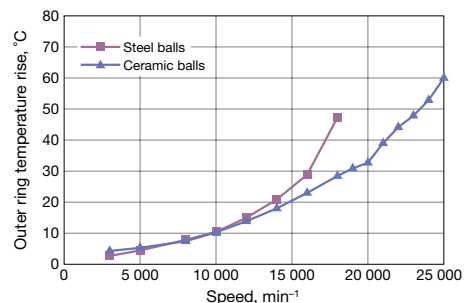

NSK Spindle that achieved 4 million $d_m n$ using ceramic ball bearings

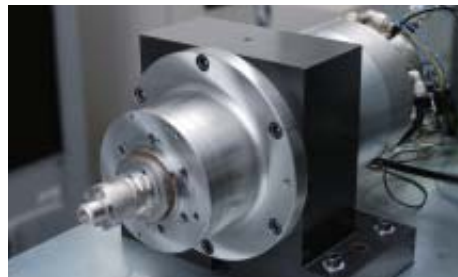

Seizure Resistance

Relative to steel balls, ceramic balls have a higher seizure resistance.

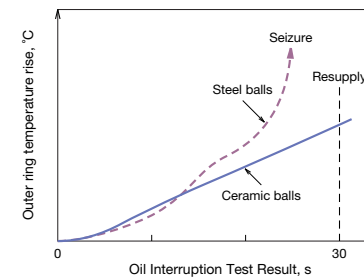

Cutting by NSK Spindle using Ceramic Ball Bearing



End Mill: $\phi 16$
Work Material: A5052
Rotational speed: 20 000 min⁻¹
2 500 cm³/min

High Rigidity

Ceramic balls have a Young's Modulus that is 50% higher than that of steel, making it an ideal material for use in machine tool spindles requiring rigid cutting performance.

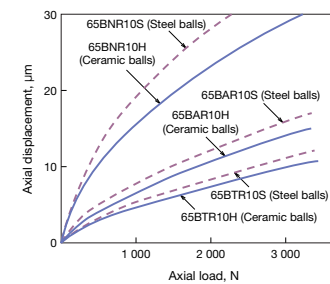

Cutting by NSK Spindle using Ceramic Ball Bearing



Face Mill: $\phi 80$
Work Material: S50C
Rotational speed: 1 200 min⁻¹
504 cm³/min

High Accuracy

NSK's expertise in the manufacturing of balls and rollers over the years along with improvements in the sintering process and the grade of materials used enables NSK to produce ceramic balls and cylindrical rollers that feature a higher level of accuracy

than steel materials. Bearings using these high-accuracy ceramic rolling elements support high-accuracy machining.

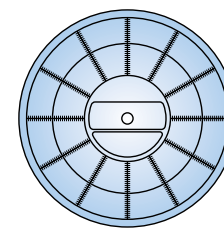

Size: 9/32"
Magnification: 50 000 times
Roundness of ceramics ball
Ceramic ball bearing

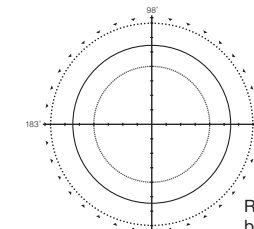

Roundness of material
being ground 0.14 μm
1 $\mu\text{m}/\text{div}$



High magnification
(200 000 times)
Sphericity measuring
equipment



Ceramic ball bearing



Ceramic roller bearing

Engineered polymer cages with higher speed capability and lower friction

Because of light weight (polymer density is 1/6 that of brass), easy formability, and high corrosion resistance, polymer materials are used widely in bearing cages. Polymers can be engineered to have lower friction and thus lower heat generation and higher speed capability. Polymers can be engineered for low wear, thus extending grease life. The engineered polymer cage is well suited for bearings used in machine tool main spindles.

Cage for Angular Contact Ball Bearings

Ball Guided Polyamide Cage (TYN)

Low Noise

- This special design allows the bearing to have lower friction and lower noise.
- This cage is effective with grease lubrication. The internal free space of the bearing in this cage is larger than that with outer ring guided cage so, it is possible to keep more grease inside of the bearing.
- The period of the grease running-in procedure for a bearing with this cage is shorter than that of a bearing, with a phenolic cage.



Ultra High-Speed Angular Contact Ball Bearings ROBUST Series

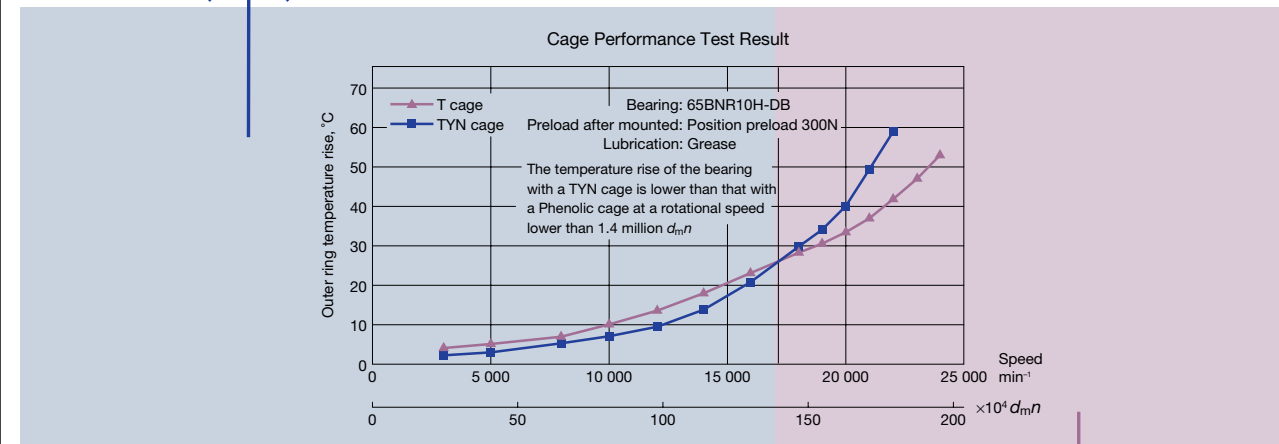

Outer Ring Guided Phenolic Cage (T, TR)

Ultra High-Speed

The rotational movement of the outer ring guided cage is more stable in high-speed operation.



Standard Series Angular Contact Ball Bearings
Standard Series
Ultra High-Speed Angular Contact Ball Bearings ROBUST Series

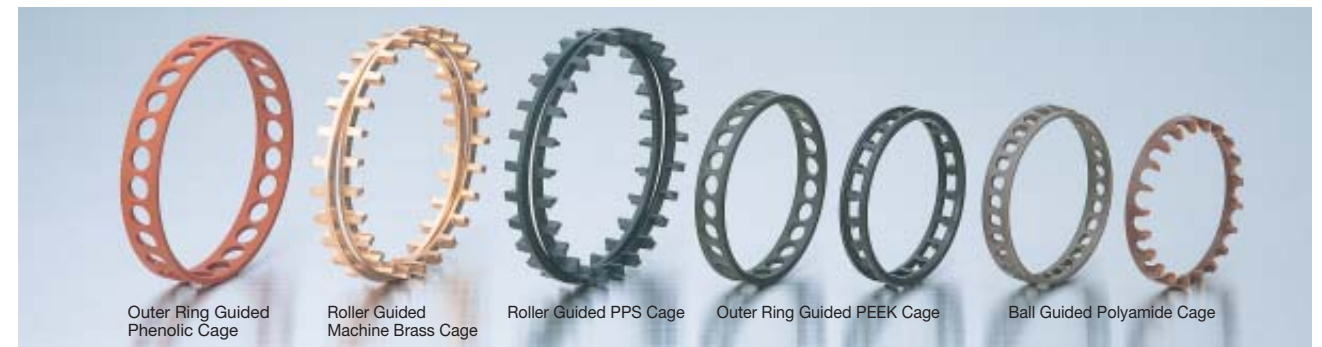
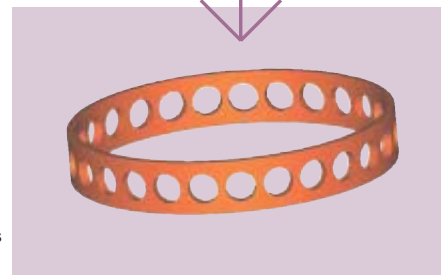

Cage for Double-Row Cylindrical Roller Bearings

Roller Guided PPS Cage (TB) Engineered Polymer

High Rigidity

- Optimal roller-guided cage design with consideration for strength and friction.
- Excellent physical properties include higher strength, toughness, wear and fatigue resistance compared to current polyamide cage material.
- High temperature resistance up to a maximum of 220°C.

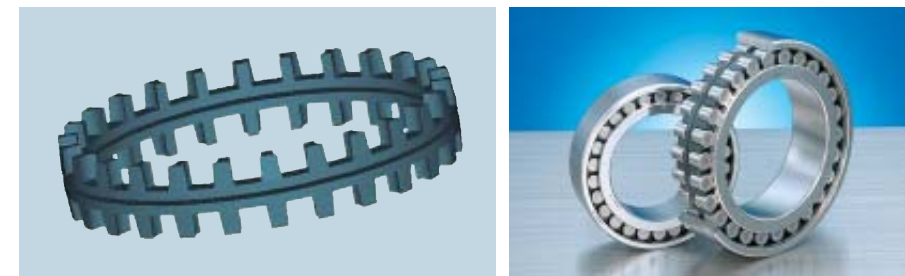

Double row CRB High Rigidity Series

Cage for Single-Row Cylindrical Roller Bearings

Outer Ring Guided PEEK Cage (TP) Engineered Polymer

Ultra High-Speed

- Minimizing cage deformation to permit stable high-speed rotation.
- High temperature resistance up to a maximum of 240°C.
- Excellent wear-resistant performance and suited to minimal oil lubrication.
- Physical properties include high strength, toughness, wear and fatigue resistance.



Ultra High-Speed Single Row CRB Robust Series

Roller Guided Machined Brass Cage (MB, MR)

General Purpose

- This cage demonstrates high temperature resistance, high strength, and high rigidity.

NSK super-precision bearings with optimal materials and internal design

Angular Contact Ball Bearings (Standard Series)

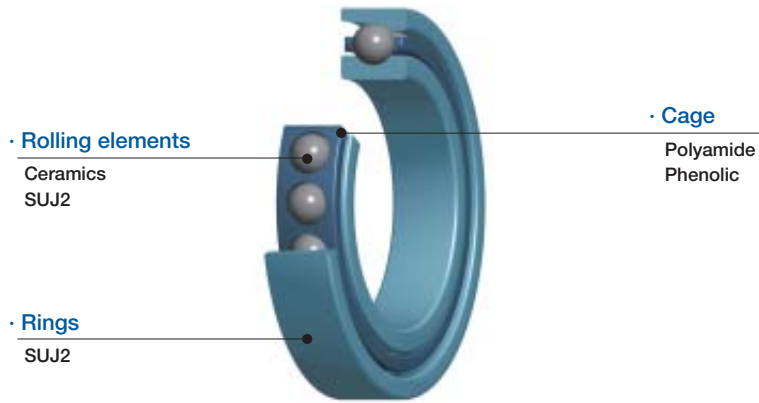

Type	Rings	Rolling elements	Cage
SUJ2 type	SUJ2	SUJ2	Polyamide 46 (TYN)
Ceramic ball type	SUJ2	Ceramics	Phenolic (TR)

Angular Contact Ball Bearings (ROBUST Series)

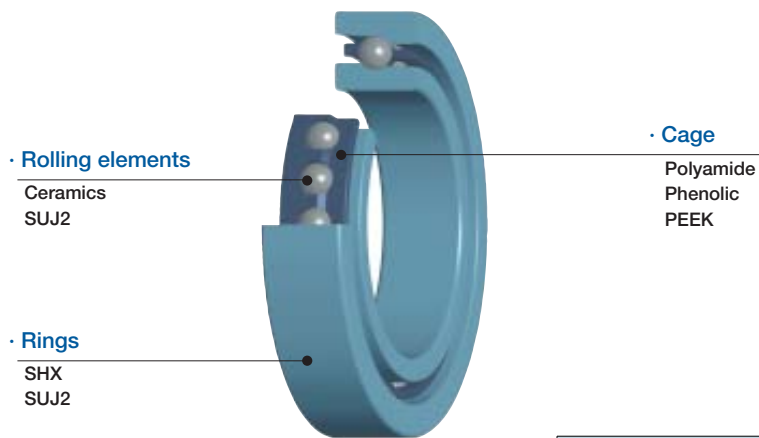

Type	Rings	Rolling elements	Cage
S	SUJ2	SUJ2	Polyamide 46 (TYN)
H	SUJ2	Ceramics	Phenolic (T)
X	SHX	Ceramics	PEEK (T42)

Cylindrical Roller Bearings

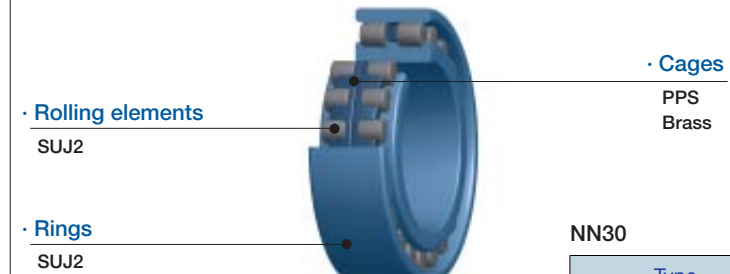

NN30

Type	Rings	Rolling elements	Cages
Standard	SUJ2	SUJ2	PPS(TB)/ Brass (MB)

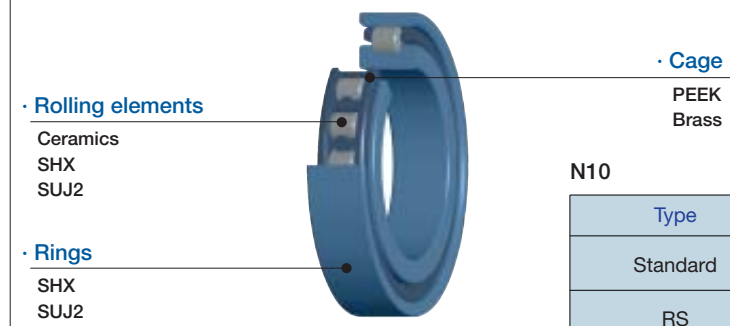

N10

Type	Rings	Rolling elements	Cage
Standard	SUJ2	SUJ2	Brass (MR)
RS	SUJ2	SUJ2	PEEK(TP)
RX	SHX	SHX	
RXH	SHX	Ceramics	

Angular Contact Thrust Ball Bearings for Ball Screw Support

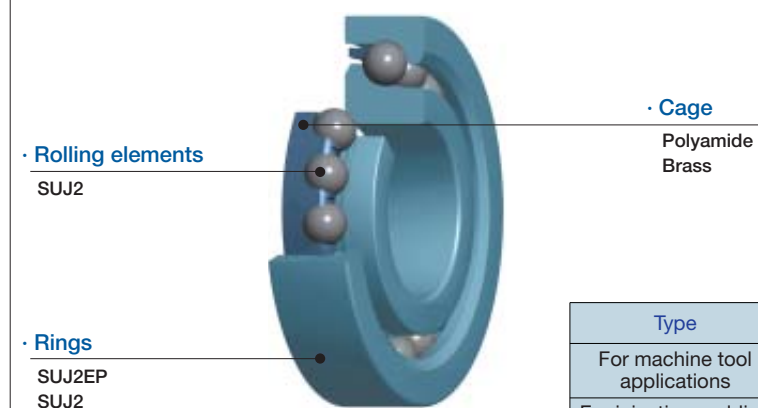

Type	Rings	Rolling elements	Cage
For machine tool applications	SUJ2EP	SUJ2	Polyamide 66
For injection molding applications	SUJ2	SUJ2	Polyamide 46/ Brass

Several types of super precision bearings are available from NSK, including the ROBUST™ series of high performance bearings, the special series of bearings for unique and specialized applications, and the standard series bearings.

ROBUST series is the high performance series of NSK super precision bearings.



High Precision Angular Contact Ball Bearings Standard Series

Standard Series
Basic NSK super precision bearings manufactured to conform to ISO standard.

- 70xx, 72xx, 79xx series
- Three types of contact angle: 15° (C), 25° (A5), 30° (A)
- Two types of cage design: Select either phenolic (TR) or polyamide (TYN), depending on application requirements



Ultra High-Speed Angular Contact Ball Bearings ROBUST Series

ROBUST Series (BNR, BER)
High performance bearings developed for high-speed operation with low temperature rise. Suitable for ultra high precision machining applications, and ultra high-speed applications.

- Two types of contact angle: 18° (BNR), 25° (BER)
- Two types of ball material: steel (S type) and Ceramic (H and X type)
- Two types of cage design: Select either phenolic (T) or polyamide (TYN), depending on application requirements
- ROBUST series also can be used for ultra high-speed applications of over 3 million $d_m n$



Sealed Angular Contact Ball Bearings Special Series

Special Series
Pregreased and sealed to reduce handling problems. Suitable for maintenance of machine tool spindles.

- Standard series super precision angular contact ball bearings
- ROBUST series high-speed angular contact ball bearings
- Bore size range: ϕ 30–100 mm in ISO series 10 and 19 (70xx and 79xx)



High-Speed Angular Contact Thrust Ball Bearings ROBUST Series

ROBUST Series (BAR, BTR)
High rigidity thrust bearings for lathe applications.

- Two types of contact angle: 30° (BAR), 40° (BTR)
- Two types of ball material: steel (S type) and Ceramic (H type)



Ultra High Precision Angular Contact Ball Bearings ROBUST Series

ROBUST Series (BGR)
High Performance bearings developed specifically for internal grinding or high-speed motor applications under spring preload.

- Bore size range: ϕ 6–25 mm, contact angle: 15°
- Two types of ball material: steel (S type) and Ceramic (H and X type)
- Non separable type
- Universal combinations (DU and SU)



Ultra High-Speed Single Row Cylindrical Roller Bearings ROBUST Series Standard Series

ROBUST Series **Standard Series**
High performance cylindrical bearings designed for ultra high-speed applications, such as machining center spindles.

- Two types of cage material: Brass (MR)⁽¹⁾ and PEEK resin (TP)
- Three types of roller material: Steel, SHX and Ceramic
- Ultra high-speed ROBUST RXH design can be used up to 2.2 million $d_m n$
- ⁽¹⁾ MR cage is used in the standard series



Double Row Cylindrical Roller Bearings Standard Series

High Rigidity Series
Designed to deliver high rigidity in high-speed applications such as lathe spindles.

- Two types of cage material: Brass (MB), PPS resin (TB)
- Standard specification E44: Outer ring oil holes and groove



Angular Contact Thrust Ball Bearings for Ball Screw Support Special Series

for Machine Tool Applications
High rigidity thrust bearings designed specifically for ball screw support applications in machine tools.

- Contact angle: 60°
- Can be universally matched to any required rigidity specification or life cycle
- A pregreased line using special grease is also available
- A new series is available, supplied with contact seals and waterproof grease

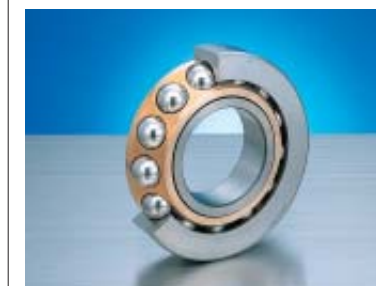

Angular Contact Thrust Ball Bearings for Ball Screw Support Special Series

for Injection Molding Machines
The high load capacity design delivers five times the life expectancy compared to ball screw support bearings for machine tool applications of a similar size. The number of rows can also be reduced.

- Easier handling than tapered roller bearings or thrust spherical roller bearings as a result of non separable configuration
- Optimum ball bearing design results in lower rotational torque
- Can be universally matched to any required rigidity specification or life cycle



High Precision Deep-Groove Ball Bearings Special Series

Special Series
Suitable for high-speed and high precision motors.

- Two types of cage: Ball guided polyamide cage (T1X, TYA)
- For quiet operation, with low vibration

Designed to achieve high-speed operation combined with low heat generation—ROBUST Series

Benefits

- 1 Low Heat Generation
- 2 High Seizure Resistance
- 3 Better Temperature Stability “Robustness”
- 4 Stable during High-Speed Operation

High performance



Spinshot™ II XE Type
 Suitable for silent operation due to reduced air-noise achieved through oil-air lubrication design

- Material of Inner/Outer Rings: Heat Resistant Steel “SHX”
- Ceramic Balls
- Cage selection based on speed requirements
- Outer Ring Guided Phenolic Cage: up to 2.5 million $d_m n$
- Outer Ring Guided PEEK Cage: over 2.5 million $d_m n$



ROBUST Series X Type
 High performance bearings demonstrating high wear and seizure resistance during ultra high-speed operation

- Material of Inner/Outer Rings: Heat Resistant Steel “SHX”
- Ceramic Balls
- Outer Ring Guided Phenolic Cage



ROBUST Series H Type
 High performance bearings that combine high-speed operation with low heat generation

- Material of Inner/Outer Rings: Steel
- Ceramic Balls
- Cage selection based on speed requirements
- Ball Guided Polyamide Cage: up to 1.4 million $d_m n$
- Outer Ring Guided Phenolic Cage: over 1.4 million $d_m n$



ROBUST Series S Type
 Steel ball bearings for optimal cost

- Material of Inner/Outer Rings: Steel
- Steel Balls
- Ball Guided Polyamide Cage

High speed

Features of “XE” series

- **High-Speed Performance (in Position Preload)**
 High-speed performance in position preload to a maximum of 2.5 million $d_m n$ with jacket cooling (Max. 2.7 million $d_m n$ without jacket cooling).
- **Silent Operation**
 Silent operation 3-5 dB quieter than conventional oil-air lubrication.
- **Orientation**
 Remains stable in either vertical or horizontal spindle orientation.
- **Reduced Air Consumption**
 Air consumption can be 1/3 relative to conventional oil-air lubrication.



Analysis Data

Sophisticated analysis software takes into account the slip inside the bearing and simulates temperature rise to establish optimum design specifications. By reducing the heat generated, ROBUST series bearings remain much more stable during high-speed operation than current series bearings.

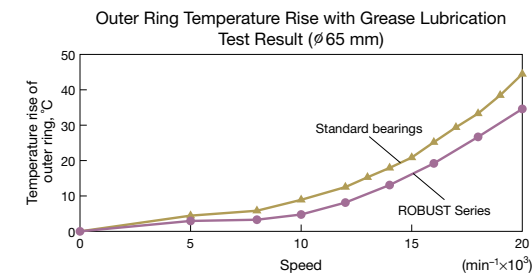
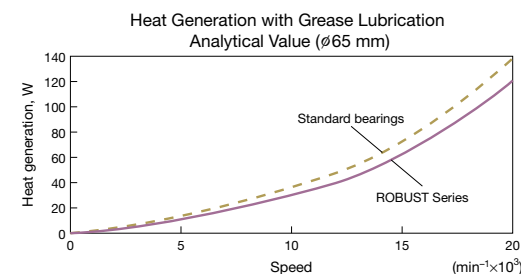

Test Data

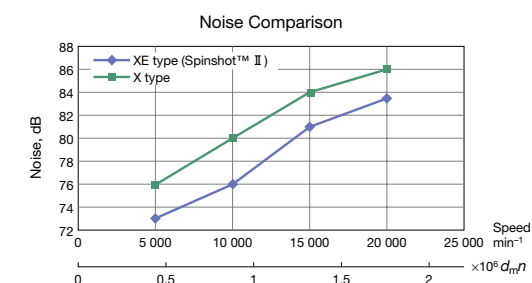
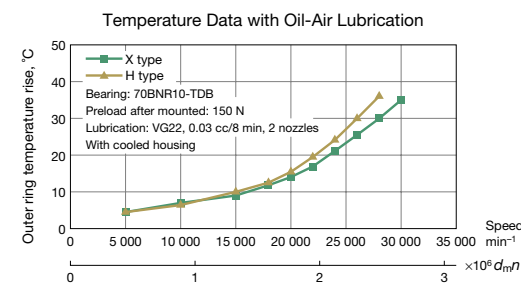
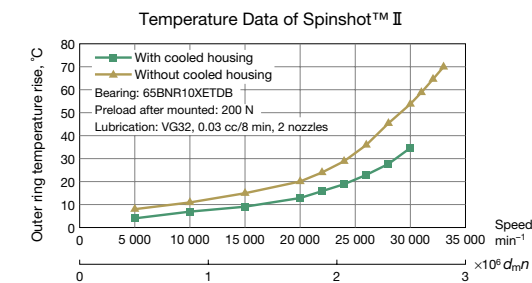
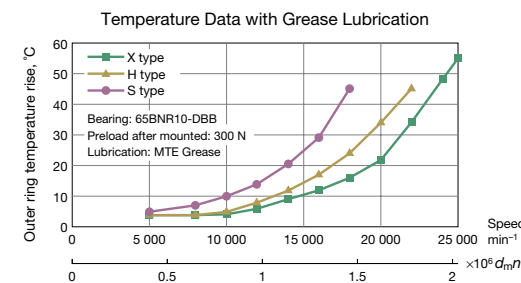

Designed to achieve high speed performance combined with high rigidity

Benefits

- 1 Low Heat Generation
- 2 Improved Seizure Resistance
- 3 Stable Operation in Ultra High Speed

High performance

Ultra High-Speed Single Row Cylindrical Roller Bearings ROBUST Series RXH Type
Highest performance for optimum seizure resistance during ultra high-speed operation

- Material of Inner/Outer Rings: Heat Resistant Steel "SHX"
- Ceramic Rollers
- Outer Ring Guided PEEK Cage

Ultra High-Speed Single Row Cylindrical Roller Bearings ROBUST Series RX Type
High performance with wear and seizure resistance during ultra high speed operation

- Material of Inner/Outer Rings: Heat Resistant Steel "SHX"
- SHX Rollers
- Outer Ring Guided PEEK Cage

Double Row Cylindrical Roller Bearings High Rigidity Series
High performance series with a newly developed polymer cage

- Material of Inner/Outer Rings: Steel
- Roller Guided PPS Cage or Roller Guided Brass Cage (Selection based on application requirements)

Ultra High-Speed Single Row Cylindrical Roller Bearings ROBUST Series RS Type
Designed to deliver cost effective high-speed performance

- Material of Inner/Outer Rings: Steel
- Steel Rollers
- Outer Ring Guided PEEK Cage

Single Row Cylindrical Roller Bearings Standard Series
Standard type bearing with brass cage

- Material of Inner/Outer Rings: Steel
- Roller Guided Brass Cage

High speed

Features of High Rigidity Double Row Cylindrical Roller Bearings

Longer Bearing Life

The PPS (engineered polymer) cage is heat resistant and provides high rigidity. As compared to a brass cage, this cage eliminates any wear particles, allowing an extended grease life.

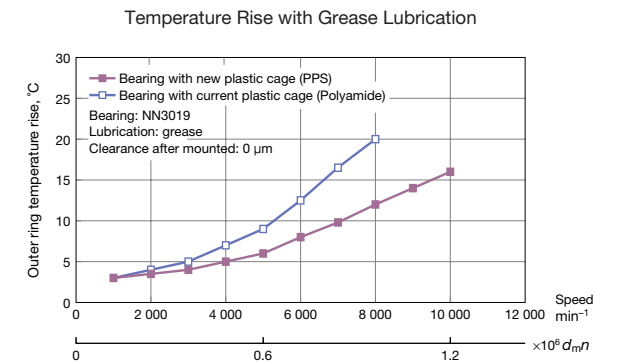
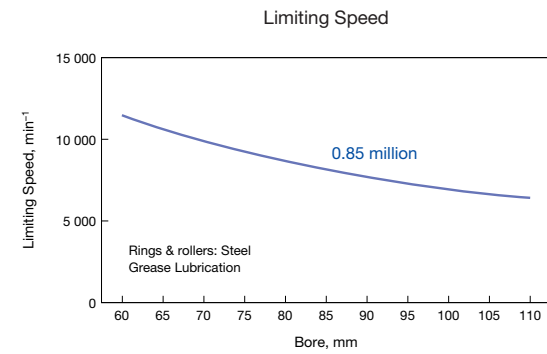

Features of the ROBUST series Ultra High-Speed Single Row Cylindrical Roller Bearings

Low Heat Generation

Internal design and advanced cage material result in low heat generation.

Seizure Resistance

RX and RXH types are made with SHX steel resulting in improved seizure resistance.

High Speed Capability

RS, RX and RXH types have cages made of heat resistant PEEK material for ultra high speed operation (over 2.0 million $d_m n$).

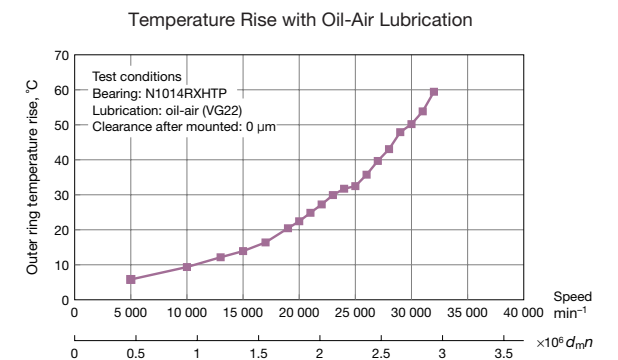
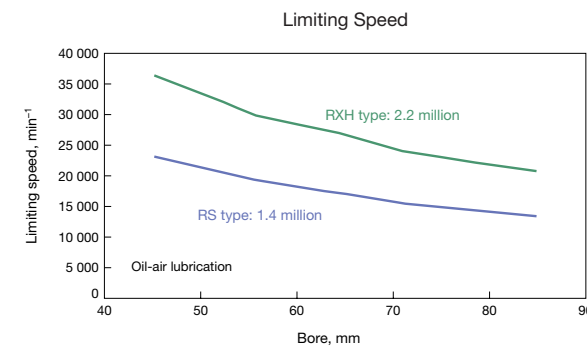

High performance bearings that combine high-speed capability with high rigidity—ROBUST Series

Benefits

- 1 High-Speed Capability
- 2 Low Heat Generation
- 3 High Accuracy



High-Speed Angular Contact Thrust Ball Bearings
BTR10 Series

40° contact angle and high axial rigidity and low heat generation. Interchangeable with TAC series.



High-Speed Angular Contact Thrust Ball Bearings
BAR10 Series

30° contact angle delivers higher speed capability. Interchangeable with BTR and TAC series.



Double Row Angular Contact Thrust Ball Bearings
TAC Series

60° contact angle with the highest axial rigidity.

Ultra high-speed internal grinding spindle bearings for high accuracy and longer life—ROBUST Series (BGR)

Benefits

- 1 Optimum Internal Design
- 2 Easy Handling Due to Non Separable Feature
- 3 Free Choice of Arrangement with Universal Combination



Features of Angular Contact Thrust Ball Bearings

- **High Accuracy**
Due to the high degree of accuracy, they are particularly suited for lathe spindle applications.
- **Interchangeable**
To adjust spindle stiffness characteristics, BTR and BAR series can be interchanged with TAC series, with minimal modification of the spindle. (See figure on the right).

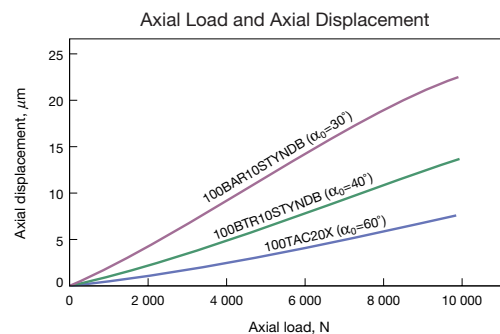
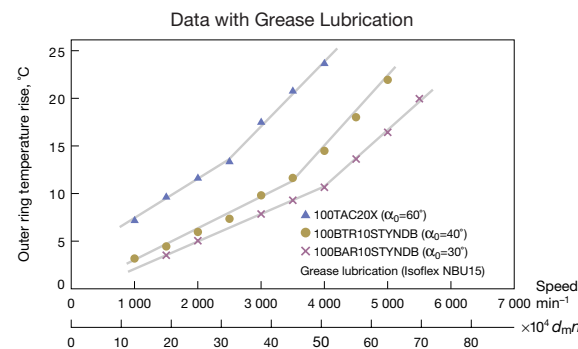
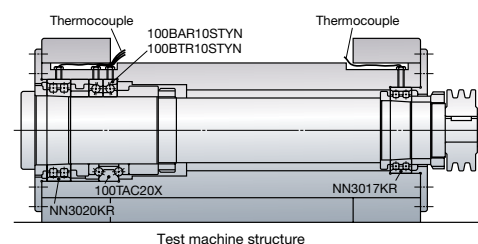

Features of the BGR Series

- **Optimum Design**
Optimum outer ring guided cage design for better lubrication. Inner ring shoulder relieved to enable a stable supply of oil into the bearing.
- **Longer Life**
Heat resistant SHX steel for longer life.
- **Easy Handling**
Non separable structure makes handling easy.
- **Ultra High Accuracy**
ISO class 2 (ABMA ABEC9) is the standard.
- **Universal Combination**
Bearings can be configured in the usual arrangements of DB/DF/DT, as well as a variety of other arrangements.

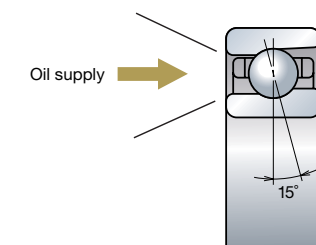

(for Machine Tool Applications)

High performance special bearings with high rigidity—TAC B Series

Benefits

- 1 Longer Life
- 2 Lower Torque
- 3 Easy Handling
- 4 High Accuracy

**Features of Ball Screw Support Bearings for Machine Tools**

- **Longer Life**
Components made from longer life EP extremely purified steel.
- **High Rigidity**
Special internal design (60° contact angle and more balls) for higher axial rigidity.
- **Lower Torque**
Lower starting torque than either tapered or cylindrical roller bearings means high rotation accuracy even at low driven power.
- **Universal Combination**
Bearings can be configured in the usual arrangements of DB/DF/DT, as well as a variety of other arrangements.
A pregreased option is also available (with Alvania No.2 grease).
- **Easy Handling and Increased Reliability**
New series with contact seals and waterproof grease has higher reliability and easier handling. Single universal combination (SU) is the standard for this series.
- **High Running Accuracy**
New polyamide cage for high running accuracy.

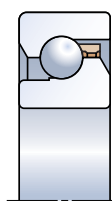

Cross Section of TAC B

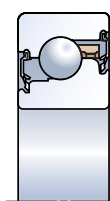

With Seal Cross Section of TAC B

(for Injection Molding Machines)

These special high performance bearings can simplify machine design and reduce costs—TAC 02, 03 Series

Benefits

- 1 Space Saving, High Load Capacity
- 2 High Reliability
- 3 Easy Handling
- 4 Reduced Torque from Optimized Design

**Features of Ball Screw Support Bearings for Injection Molding Machines**

- **High Reliability**
High load capacity design delivers five times the life value compared to the similarly sized TAC B series.
- **Easy Handling**
Easier to handle and use than tapered roller bearings or thrust spherical roller bearings due to the non separable design.
- **Simplified Design Leads to Reduced Costs**
Preload is preset so assembly is fast and without any preload adjustment. Design of special parts for preload adjustment is unnecessary, which saves time and cost.
- **Lower Rotational Torque**
Optimal internal design for lower torque (i.e., in cases where roller bearings are currently being used because of large load, these bearings can be used to reduce the bearing torque generated by roller bearings).



Cross Section of the Bearing for Machine Tools and Injection Molding Machines

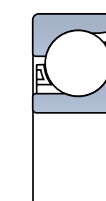

Cross Section of TAC03AT85

Suitable for spindle maintenance—ROBUST Series and Standard Series

Features of Sealed Angular Contact Ball Bearings

- **Easy Handling**
No need to grease the bearing during spindle assembly.
- **Environmentally Friendly**
Sealed design avoids grease loss.

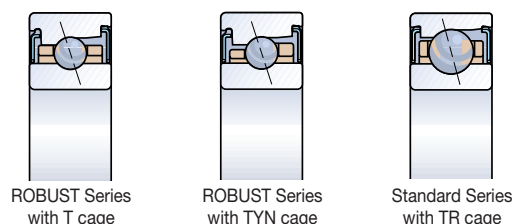

Sealed Precision Spacers

Sealed spacers eliminate the possibility of contamination
Precision spacers available for machine tool spindles

Features of Sealed Precision Spacers

- **Environmentally Friendly**
Sealed design prevents grease loss.
- **High Reliability**
Reduced contamination from dust or coolant in grease lubricated spindles.

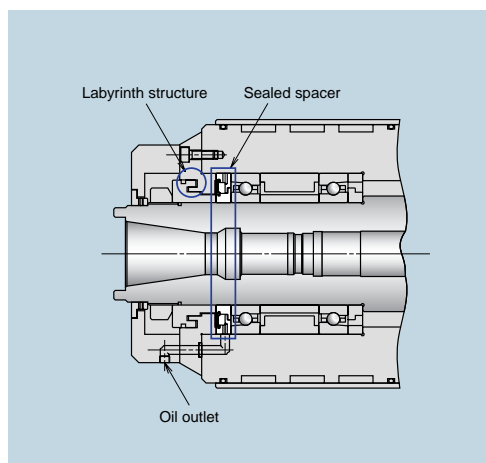

MTS, MTE, ENS

Features of Greases for Machine Tool Spindles

- MTS** Contains urea thickener and delivers higher heat resistance. Recommended for use with ultra high speed machine tool spindles
- MTE** Formulated to handle higher load capacities. Recommended for use in high speed machine tool spindles.
- ENS** Environmentally friendly thanks to biodegradability.



MTE and MTS are available in 100 g tubes as well as 1 kg cans.

Characteristics of each grease

Items	Condition	MTS	MTE	ENS	Test Method
Thickener	—	Urea	Barium Complex	Urea	—
Base Oil	—	Ester+Synthetic hydro carbon oil	Ester Oil	Polyol Ester Oil	—
Kinematic Viscosity of Base Oil (mm ² /S)	40°C	22	23	32	JIS K2283
Worked Penetration	25°C, 60 W	2-3	2	2	JIS K2220 (Clause7)
Dropping Point (°C)	—	> 220	> 200	> 260	JIS K2220 (Clause8)
Evaporation (mass%)	99°C × 22 H	0.3	0.4	0.4	JIS K2220 (Clause10)
Oil Separation (mass%)	100°C × 24 H	0.4	1.0	1.1	JIS K2220 (Clause11)

Selecting the Right Bearing is Critical

Precision bearings are designed to deliver the high accuracy, high rotational speed, and high rigidity needed for demanding machine tool applications. As each application has its own unique requirements, and each type of bearing has different characteristics, it is essential to select the type of bearing based on the specific demands of a given application.

Take Advantage of NSK Technical Support when Selecting Bearings

NSK is committed to helping customers select the proper bearings that will deliver the best performance based on the application involved.

When designing a new spindle, including ultra high speed, specialized or custom applications, or making your bearing selection, please don't hesitate to ask us for technical assistance. We have the experience and expertise in state-of-the-art, high speed, main shaft spindle technology to assure that you get the very best bearings for your application.

For more information on the latest NSK technology, please visit our Web site or call today.

NSK Web Site

<http://www.nsk.com>

Contents

Part3.	Bearing Selection	P36
	Typical High-Speed Main Shaft Spindle Structures	P38
	Other Spindle Structures	P40
	Features of Angular Contact Ball Bearings	P42
	Features of Cylindrical Roller Bearings	P44



The chart below outlines the correct five step procedure to follow when selecting the proper bearing for a typical high-speed spindle application, including the factors to be considered in each stage of the selection process.

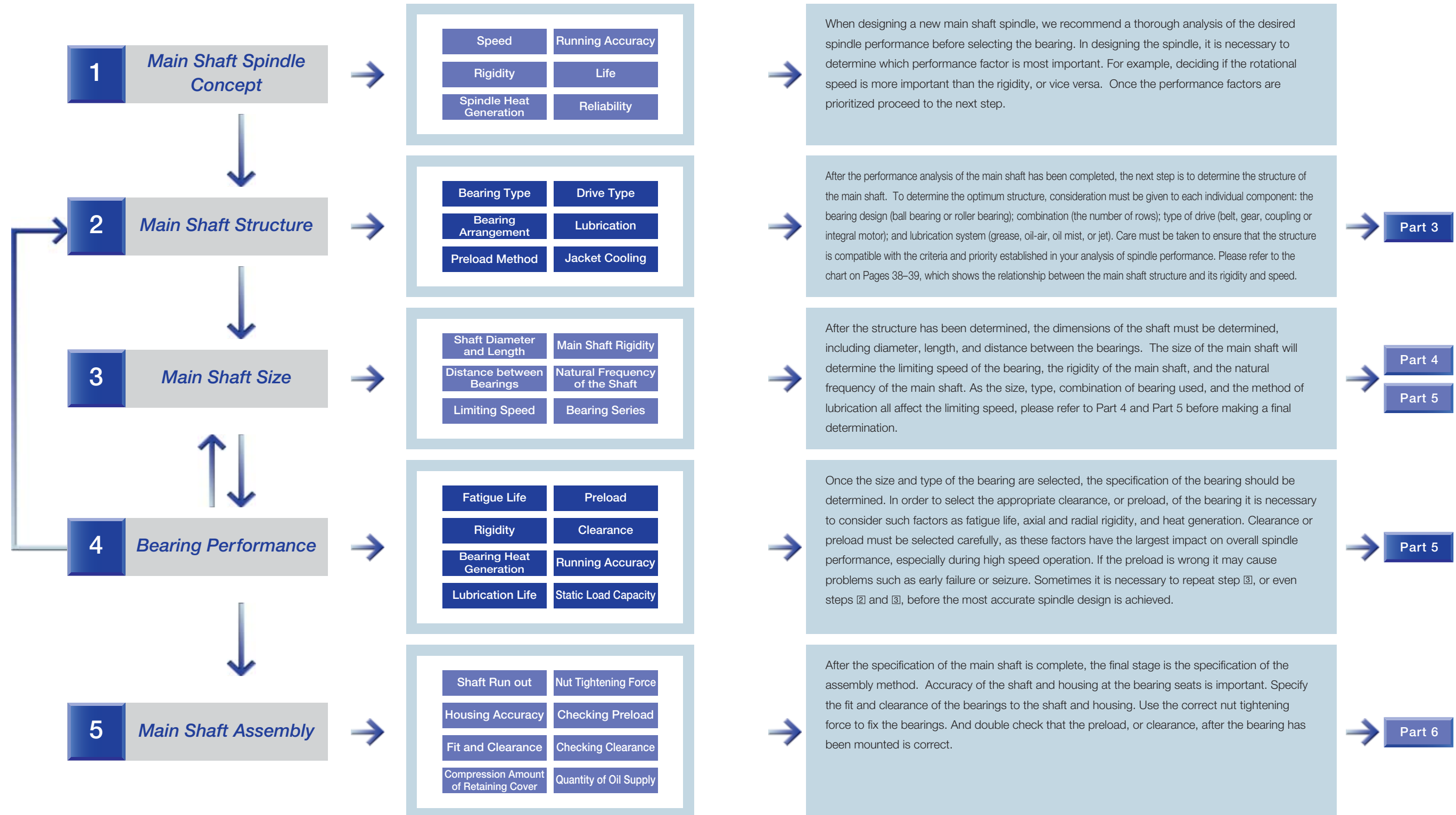

Remember, NSK technical support is always at your disposal when designing a new spindle, an ultra high-speed spindle or a spindle for a unique specialized application. We offer customers our experience and our expertise in advanced technology.

Rotational Speed ($d_m n$)

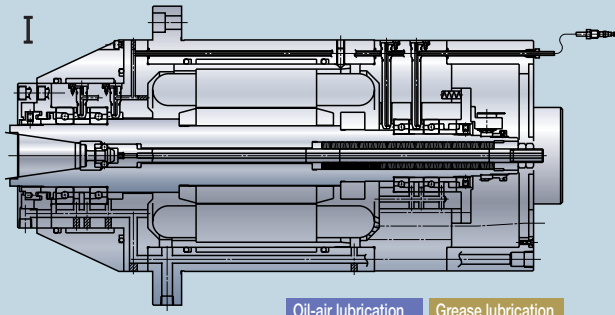

Oil-air lubrication $d_m n \nearrow 3.5M$ Grease lubrication $d_m n \nearrow 2.0M$

Bearing Arrangement I

Front side: Ultra high-speed angular contact ball bearing duplex sets (DT)
 Rear side: Ultra high-speed angular contact ball bearing duplex sets (DT)

Spindles with this arrangement are suited for ultra high speed operation and use constant pressure preload. Although this spindle has lower rigidity it delivers higher speed capability with a lower temperature rise performance relative to a spindle with position preload.

Applications: Machining Center, Grinding Machine, High Frequency Spindle, etc.

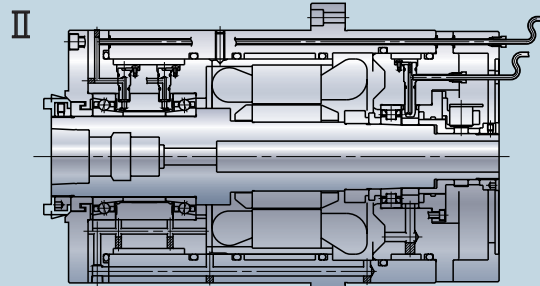

Oil-air lubrication $d_m n \nearrow 2.5M$ Grease lubrication $d_m n \nearrow 1.5M$

Bearing Arrangement II

Front side: Ultra high-speed angular contact ball bearing duplex sets (DB)
 Rear side: Ultra high-speed single row cylindrical roller bearing (In case of angular contact ball bearings, either position or constant pressure preload is applicable)

Spindles with this arrangement are suited for ultra high-speed operation and use position preload. They achieve higher radial and axial rigidity than spindles with Bearing Arrangement I. It is possible to use a cylindrical roller bearing on the rear side, for better slide performance.

Applications: Machining Center, Grinding Machine, High Frequency Spindle, etc.

Bearing Arrangement III

Front side: Ultra high-speed angular contact ball bearing quad sets (DBB)
 Rear side: Ultra high-speed single row cylindrical roller bearing (In case of angular contact ball bearings, either position or constant pressure preload is applicable)

Spindles with this arrangement will have lower speed capability, and higher radial and axial rigidity relative to Bearing Arrangement II.

Applications: NC Lathe, NC Milling Machine, Machining Center, etc.

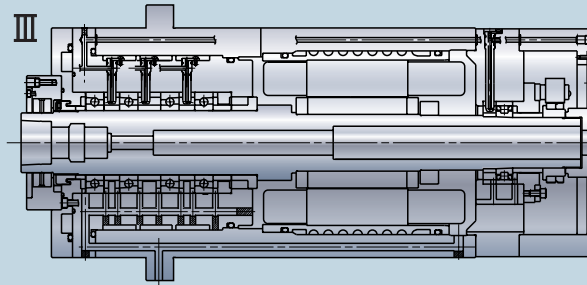

Oil-air lubrication $d_m n \nearrow 2.2M$ Grease lubrication $d_m n \nearrow 1.3M$

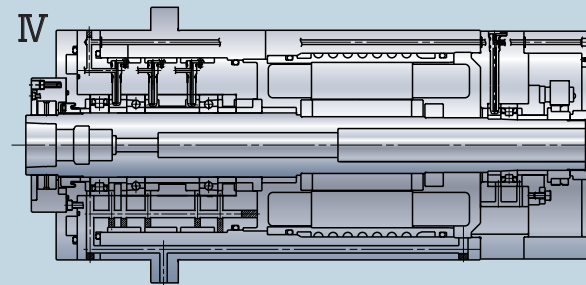

Oil-air lubrication $d_m n \nearrow 2.2M$ Grease lubrication $d_m n \nearrow 1.3M$

Bearing Arrangement IV

Front side: Ultra high-speed single row cylindrical roller bearing, angular contact ball bearing duplex sets (DB)
 Rear side: Ultra high-speed single row cylindrical roller bearing (In case of angular contact ball bearing, either position or constant pressure preload is applicable)

Spindles with this arrangement have high-speed capability similar to spindles with Bearing Arrangement III. As there is a cylindrical roller bearing in the front side, the radial rigidity is high, so it is possible to have both high speed and heavy cuts.

Applications: NC Lathe, NC Milling Machine, Machining Center, etc.

Bearing Arrangement V

Front side: Ultra high-speed angular contact ball bearing triplex sets (DBD)
 Rear side: Ultra high-speed single row cylindrical roller bearing (In case of angular contact ball bearing, either position or constant pressure preload is applicable)

Spindles with this arrangement will have lower speed capability, and higher radial and axial rigidity relative to Bearing Arrangement II, and lower speed capability and rigidity relative to Bearing Arrangements III and IV.

Applications: NC Lathe, NC Milling Machine, Machining Center, etc.

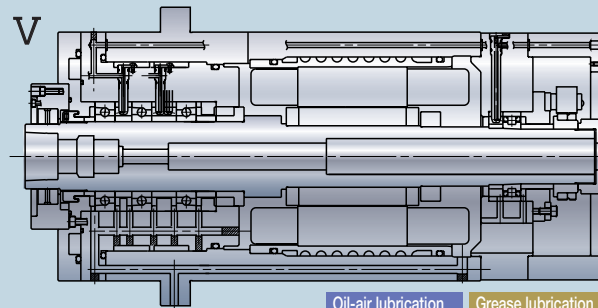

Oil-air lubrication $d_m n \nearrow 1.8M$ Grease lubrication $d_m n \nearrow 1.2M$

Bearing Arrangement VI

Front side: High rigidity double row cylindrical roller bearing, angular contact ball bearing duplex sets (DB)
 Rear side: High rigidity double row cylindrical roller bearing

Although spindles with this arrangement have lower speed capability, the radial and axial rigidity of these spindles are highest.

Applications: NC Lathe, NC Milling Machine, Machining Center, etc.

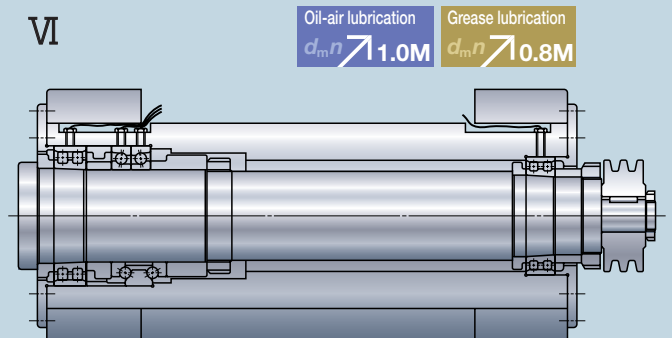

Oil-air lubrication $d_m n \nearrow 1.0M$ Grease lubrication $d_m n \nearrow 0.8M$

Rigidity of the Main Shaft

Boring Head

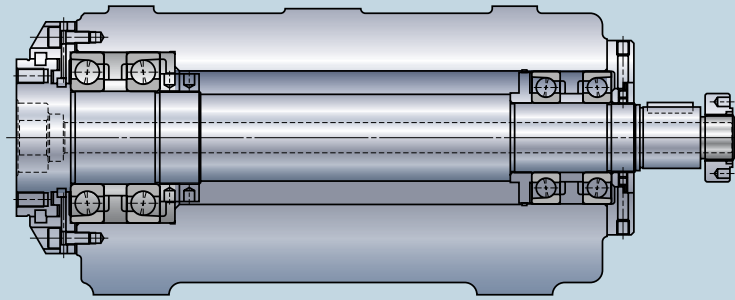

High Precision Spindle for Lathe

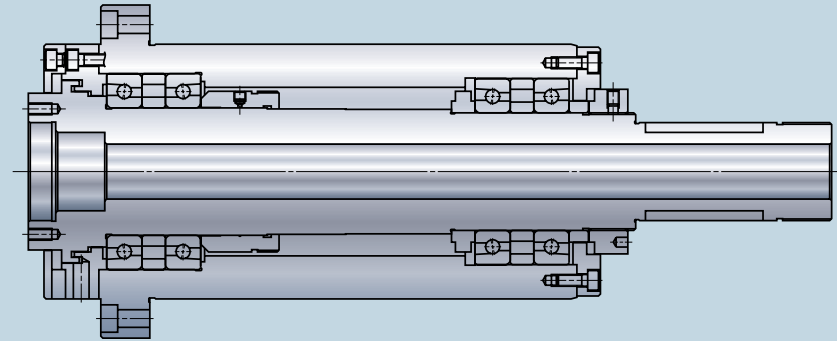

Grinding Spindle

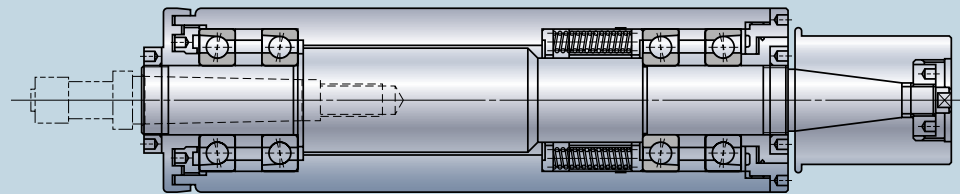

Live Center

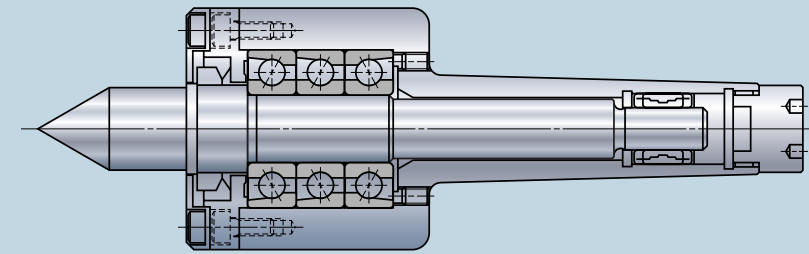

High Frequency Spindle

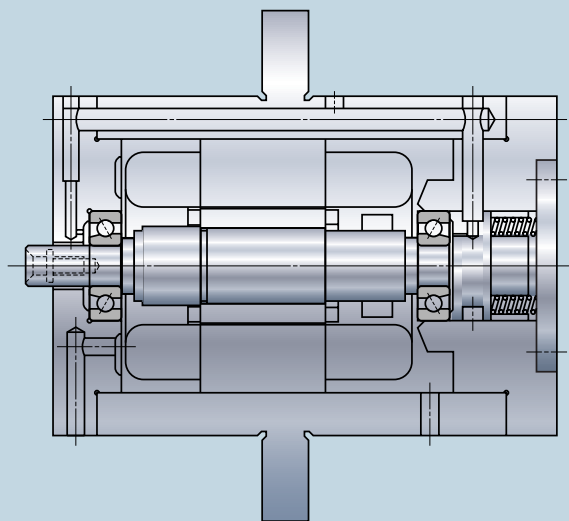

Work Head Spindle

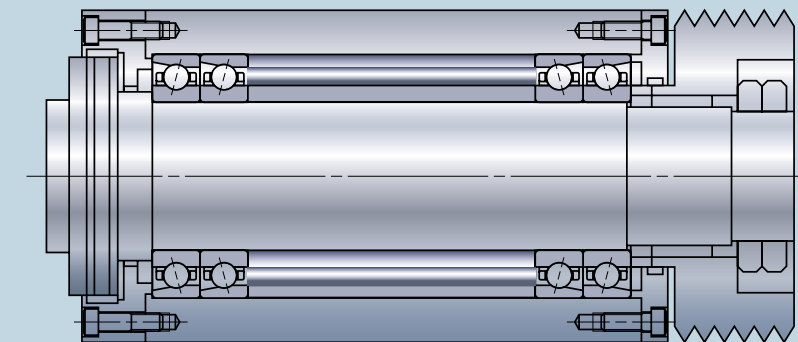

The main features of the Angular Contact Ball Bearing (ACBB)

■ A predefined contact angle

■ They are used in matched combinations with preload

In selecting Angular Contact Ball Bearings, it is important to consider the above two features, as each angular control ball bearing has specific features and performance. Be sure to carefully consider the effects of changes in contact angle and preload on performance so that you select the ACBB that is best suited to the application. The following graphs summarize the relative performance of each type of ACBB (by series and dimensional series), depending on the contact angle, preload, and combination.

Performance Comparison of Each Type of Bearing (bore size 70 mm, DB combination, L preload)

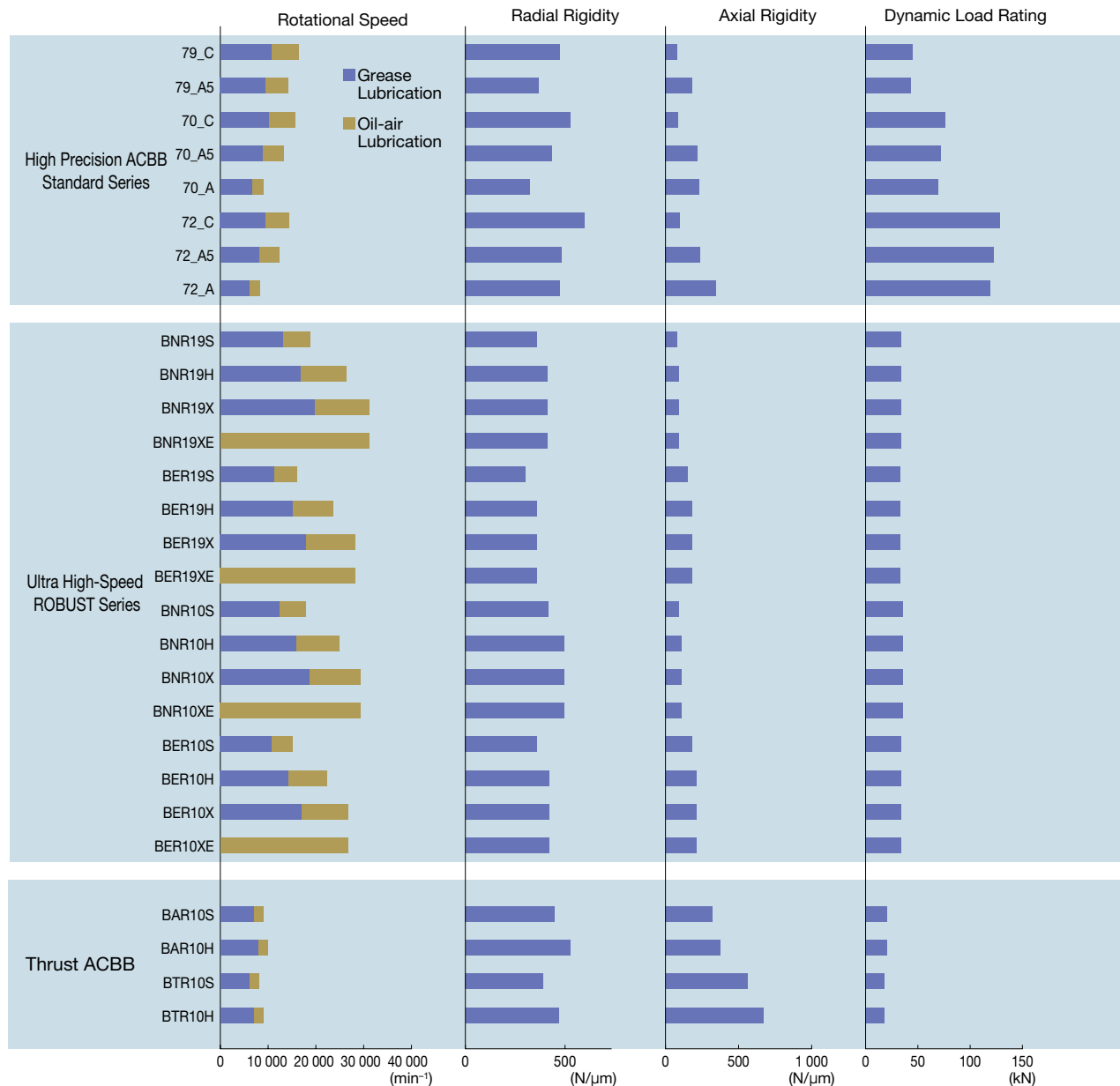

The Effect of Contact Angle

As the contact angle increases, Angular Contact Ball Bearings have a higher axial load capacity, but a lower speed capability. Thus, the ACBB with a smaller contact angle is better suited for high speed and high radial load applications.

The figure below compares the rigidity, limiting speed and temperature rise of a 7020 Angular Contact Ball Bearing with different contact angles: C angle (15°), A5 angle (25°) and A angle (30°). Under the same light preload level (L), the bearing with C angle has higher radial rigidity with lower temperature rise relative to the bearing with A angle. The bearing with A angle has the highest axial rigidity, three times higher than that of the bearing with C angle, but the limiting speed is lower than the others.

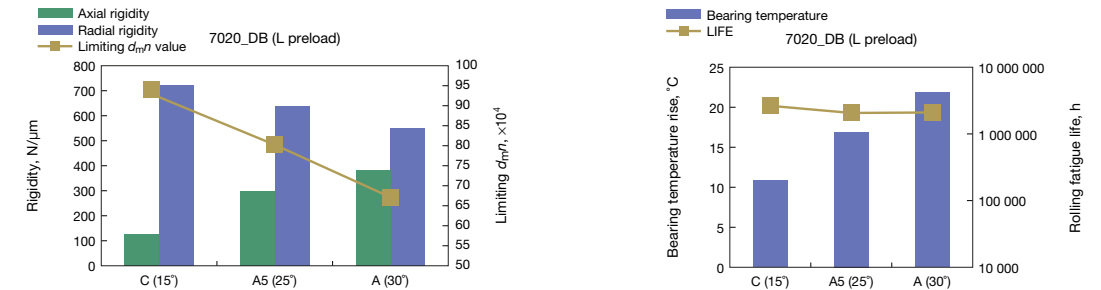

The Effect of Preload

Preload affects performance of ACBBs in much the same way that the contact angle does. As preload increases, the rigidity increases but the speed capability decreases. NSK has defined standard preload levels as Extra Light (EL), Light (L), Medium (M) and Heavy (H). The figure below compares the performance of a 7020CDB with each preload level. Even if the contact angle is held constant, when the preload is larger, both axial and radial rigidity are increased. However the temperature also rises, so the limiting speed and calculated life become lower.

In order to maintain high rigidity, it is necessary to sacrifice higher speed. Similarly to accomplish higher speed, it is necessary to sacrifice high rigidity. Caution must be exercised. If too high a preload is combined with high operation speed, there is a possibility of seizure.

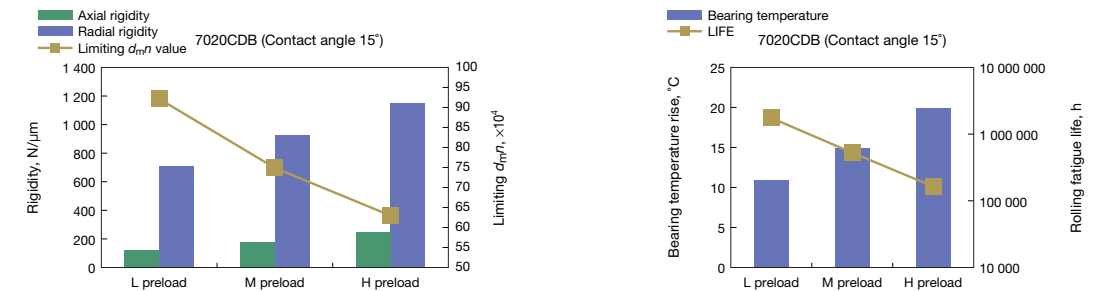

The Effect of Combination

ACBBs are usually used as multiple bearing sets. There are three types of combinations—Back-to-Back (DB), Face-to-Face (DF) and Tandem (DT). Two row, three row, and four row are the most popular multiple bearing sets. When the combination is held constant, and the number of rows is increased, the rigidity and the load capacity become larger, but the limiting speed becomes lower.

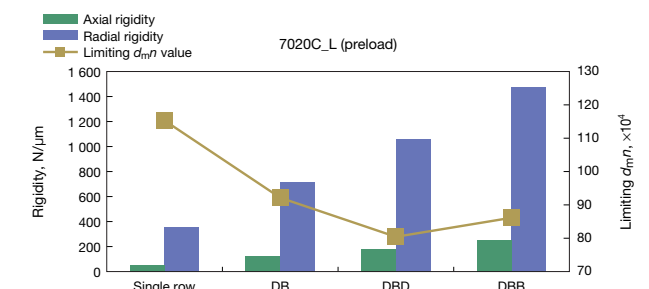

Cylindrical Roller Bearing (CRB)

- Cylindrical roller bearings support only radial loads, but have the advantage of a larger radial load capacity rating than ACBBs. Double row cylindrical roller bearings (NN and NNU types) and single row cylindrical bearings (N type) are available.
- In general, double row cylindrical roller bearings are used for high rigidity applications such as lathes, while single row cylindrical roller bearings are used in high-speed applications such as machining centers. The following graphs display cylindrical roller bearing performance depending on the type of bearing (by series and dimensional series) and the radial clearance involved.

Performance Comparison Relative to CRB Type: (bore size 100 mm)

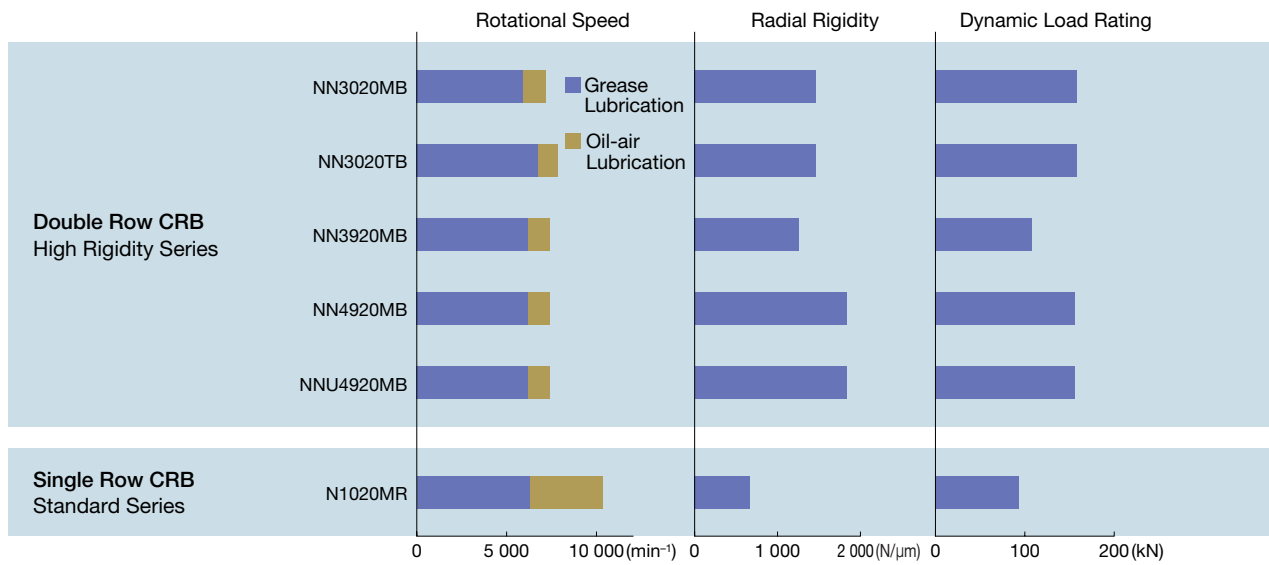

Performance Comparison Relative to CRB Type: (bore size 70 mm)

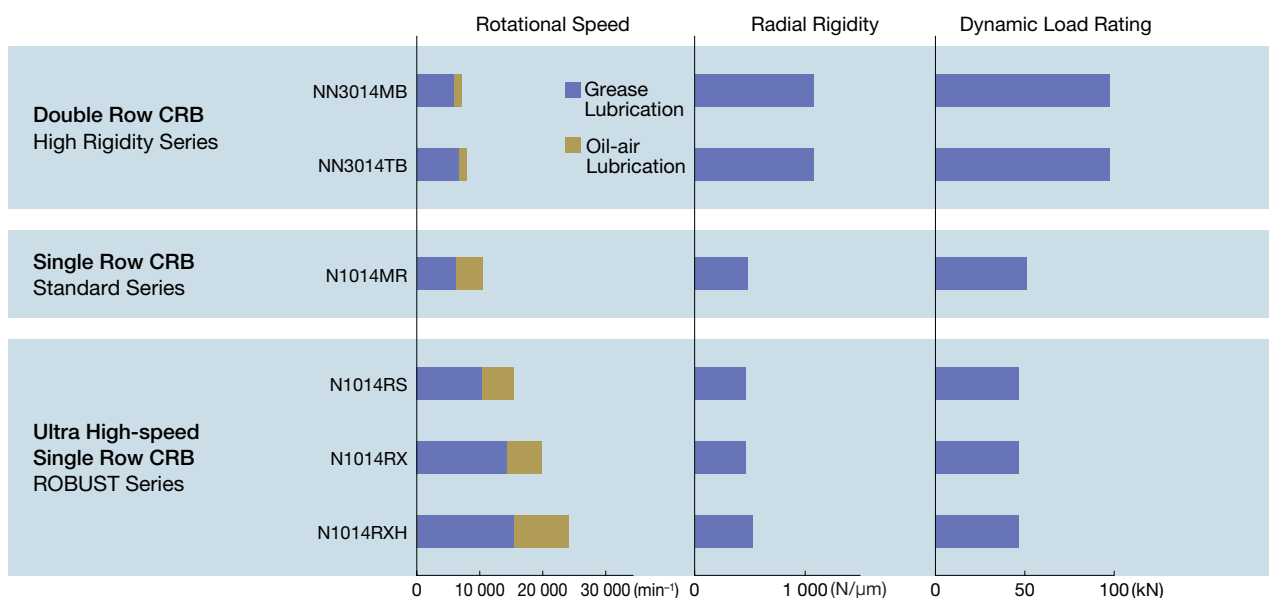

The Effect of the Radial Clearance

When using cylindrical roller bearings, it is important to control the radial clearance since it will have the greatest impact on bearing performance.

As the radial clearance increases, both rigidity and calculated fatigue life decrease. With higher radial clearances heat generation during operation also decreases. Conversely, as the figure below illustrates, rigidity is not increased if the radial clearance drops below -0.003 mm, while the calculated fatigue life continues to decrease. Therefore, the optimum clearance target to achieve high rigidity and long life is zero or just slightly negative clearance.

For applications involving high speed, it is necessary to control the clearance during operation. Properly adjusting the radial clearance when the bearing is installed to compensate for the effects of high speed operation does this.

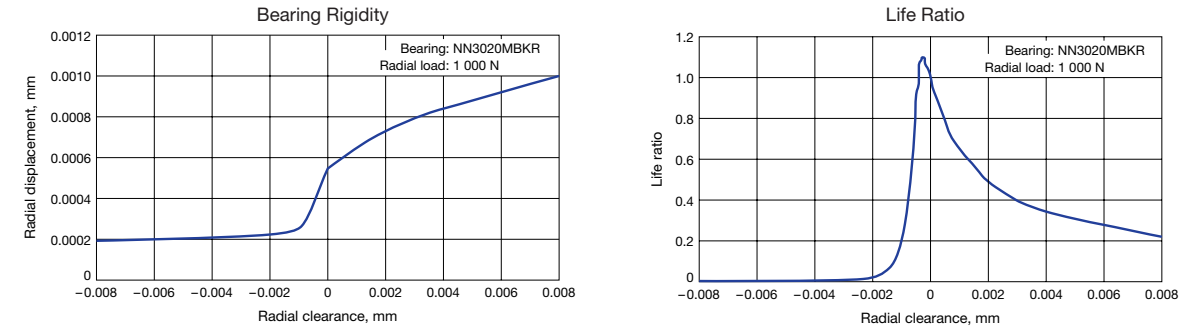

The Relationship Between Radial Clearance and Temperature Rise

The figure at the right shows test result of the temperature rise of CRB.

After-mounted Radial Clearance
Bearing (1): $0 \mu\text{m}$
Bearing (2): $-30 \mu\text{m}$

The temperature rise of bearing (2) is larger and the limiting speed is lower than bearing (1), clearly demonstrating the importance of properly controlling the clearance.

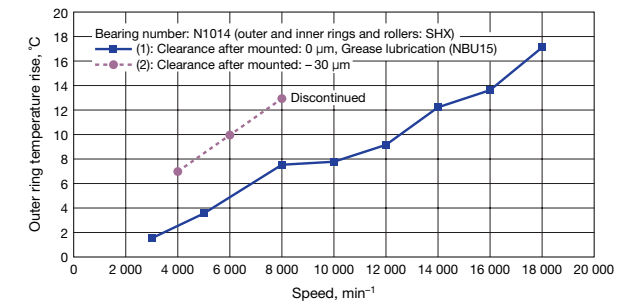

A CRB with a tapered bore is used to control radial clearance during spindle assembly because it is easy to adjust the radial clearance to any value. For a CRB with a tapered bore, the popular unmounted noninterchangeable radial clearance classes are CC9, CC0, and CC1. The specific features of each are outlined below.

NSK's recommended clearance

• CC0

Matched clearance range less than CC1. This range overlaps with the upper values of CC9 and lower values of CC1. As this clearance is easy for customers to target this range, it is the recommended clearance offered for CRB with taper bore.

• CC1 clearance

Matched clearance range is greater than CC0. While not the standard, this clearance is most popular in the field. When clearance is at its maximum, special care is required to accommodate expansion of the inner ring. If care is not used, and the spindle's cross-section is thin, deformation of the bearing or shaft may occur.

• CC9 clearance

Matched clearance range is less than CC0. This clearance will help avoid potential deformation of the inner ring or the shaft when there is little tolerance for inner ring expansion. Since the radial clearance is reduced to the minimum, the interference between the inner ring and the shaft becomes small. In high speed applications, this may cause loosening of the inner ring from the shaft and result in some creep damage.



High Precision Angular Contact Ball Bearings

Standard Series



Ultra High-Speed Angular Contact Ball Bearings

ROBUST Series



Ultra High-Speed Angular Contact Ball Bearings

Spinshot™ II



Ultra High Precision Angular Contact Ball Bearings

BGR Series

Angular Contact Ball Bearings

High Precision Angular Contact Ball Bearings (Standard Series) ...P48-60

Features

Numbering System

Bearing Tables

Miniature Series, BSA Series for Ball Screw Support

79 Series

70 Series

72 Series

Ultra High-Speed Angular Contact Ball Bearings (ROBUST Series) ...P62-79

Features

Numbering System

Bearing Tables

BNR19, BER19 Series

BNR10, BER10 Series

BNR19XE/10XE, BER19XE/10XE Series (Spinshot™ II)

BNR29, BER29 Series (Wide Series)

BNR20, BER20 Series (Wide Series)

Ultra High Precision Angular Contact Ball Bearings (ROBUST Series—BGR) ...P80-84

Features

Numbering System

Bearing Tables

BGR19 Series

BGR10 Series

BGR02 Series

Angular Contact Ball Bearings

High Precision Angular Contact Ball Bearings (Standard Series)

Features

Single-row angular contact ball bearings have a line connecting the contact points drawn in the radial direction, which is called the contact angle. The contact angle makes this bearing suitable for accommodating radial loads, single direction axial loads, and a combination of both. Furthermore, since an axial component is generated when a radial load is applied, these bearings are generally used in pairs, triplex sets, quadruplex sets, or multiplex sets.

Contact Angle

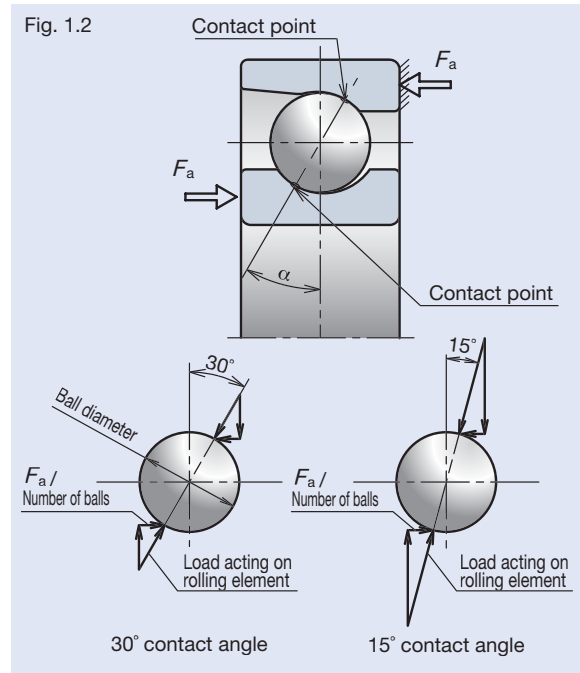
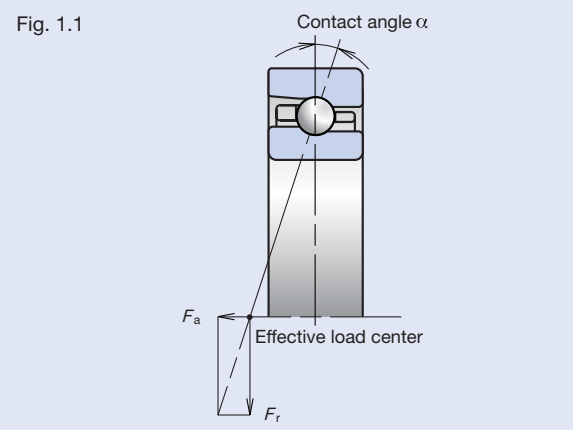

Fig. 1.1



When a load is applied to an angular contact ball bearing, elastic deformation and the amount of stress at the contact point changes as a result of the varying load conditions of the balls, inner ring, and outer ring according to the contact angle of the bearing.

Figure 1.2 illustrates loads acting on two rolling elements for a 30° contact angle, and a 15° contact angle. The relation between an axial load being applied to the bearing and resulting load acting on the rolling element can be formulated as:

$$F_a / (\text{Number of balls} \times \sin \alpha)$$

Therefore, the larger the contact angle, the smaller the load acting on the rolling element. Load at the contact point, and its consequential deformation, is reduced thus resulting in longer life. When a radial load is applied, the smaller the contact angle, the smaller the load acting on the rolling element, thus resulting in reduced load at the contact point.

(See Pages 42 and 43 for contact angle specifics.)

Dimension Series

Fig. 1.3

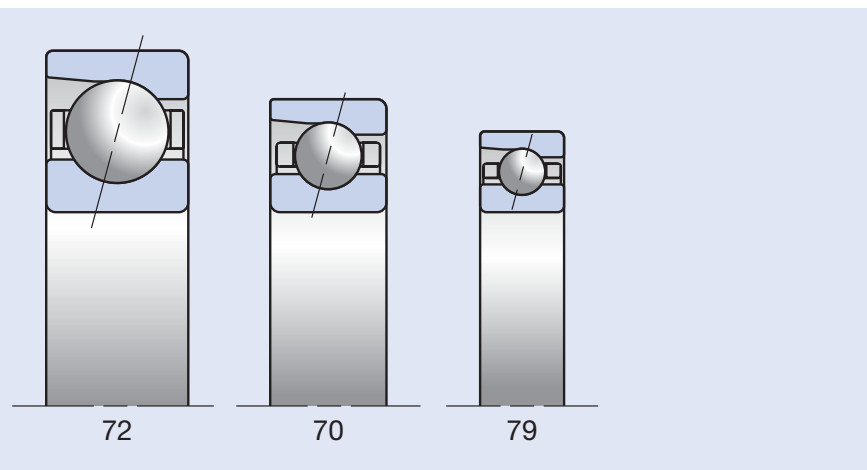

Numbering System of High Precision Angular Contact Ball Bearings (Standard Series)

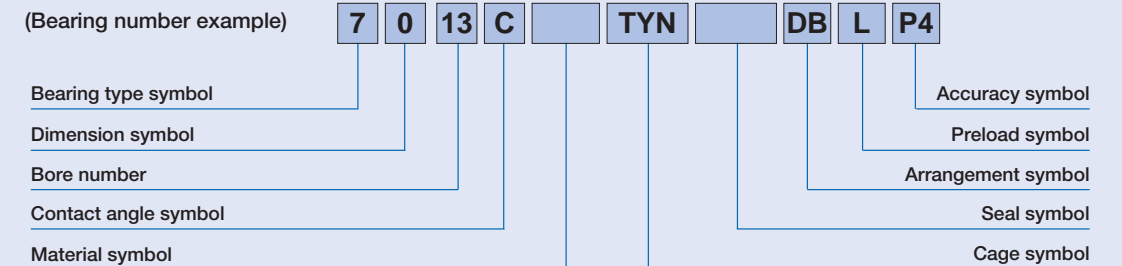

		Reference pages
7	Bearing type	7: single-row angular contact ball bearing 42-43, 48
0	Dimension	9: 19 series, 0: 10 series, 2: 02 series 42-43, 48
13	Bore number	Less than 03, Bearing bore 00: 10 mm, 01: 12 mm 02: 15 mm, 03: 17 mm Over 04, Bearing bore Bore number × 5 (mm) 50-60
C	Contact angle	C: 15°, A5: 25°, A: 30° 42-43, 48
	Material	No symbol: bearing steel (SUJ2) SN24: ceramic ball (Si ₃ N ₄) (1) 14-17
TYN	Cage	TYN: ball guided polyamide resin cage; limiting speed $d_m n = 1\,400\,000$; operational temperature limit = 120°C TR: outer ring guided phenolic resin cage; operational temperature limit = 120°C 18-19
	Seal	No symbol: open type V1V: non-contact rubber seal (2) 32
DB	Arrangement	SU: universal arrangement (single row) DU: universal arrangement (double row) DB: Back-to-back arrangement DF: Face-to-face arrangement DT: tandem arrangement DBD, DFD, DTD, DUD: triplex set arrangement • DBB, DFF, DBT, DFT, DTT, QU: quadruplex set arrangement 42-43 148-151
L	Preload	EL: extra light preload, L: light preload, M: medium preload, H: heavy preload CP: special preload, CA: special axial clearance 42-43 152-160
P4	Accuracy	P2: ISO Class 2, P4: ISO Class 4, P5: ISO Class 5 P3: special class (dimensional accuracy: ISO Class 4; rotating accuracy: ISO Class 2) P4Y: special class (Bore diameter and outside diameter are exclusive to NSK. All others are ISO Class 4.) 151 176-179

(1) Angular contact ceramic ball bearing correspondence numbers 79, 70: Bore diameter= ϕ 10-100 mm.

(2) Sealed angular contact ball bearings are standardized for SU arrangement and ISO Class 3.

Sealed angular contact ball bearing correspondence numbers 79, 70: Bore diameter= ϕ 30-100 mm.

1. ANGULAR CONTACT BALL BEARINGS

High Precision Angular Contact Ball Bearings (Miniature Series)

70 Series 72 Series

Bore Diameter 5-8 mm

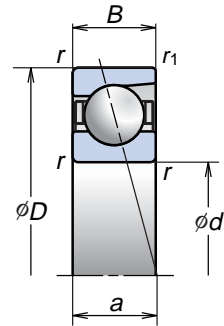

Bearing Numbers	Boundary Dimensions (mm)					Basic Load Ratings (kN)		Permissible Axial Load (1) (kN)	Effective Load Center (mm) a	Mass (g) (approx.)	Limiting Speeds (2) (min ⁻¹)	
	d	D	B	r (min.)	r ₁ (min.)	C _r (Dynamic)	C _{0r} (Static)				Grease	Oil
725C	5	16	5	0.3	0.15	1.700	0.660	0.545	3.91	4.5	110 000	167 000
725A	5	16	5	0.3	0.15	1.610	0.620	0.665	5.53	4.5	72 000	96 000
706C	6	17	6	0.3	0.15	2.150	0.845	0.765	4.54	5.5	100 000	153 000
706A	6	17	6	0.3	0.15	2.030	0.795	0.725	6.32	5.5	66 000	87 000
726C	6	19	6	0.3	0.15	2.390	1.000	0.835	4.67	7.8	92 000	140 000
726A	6	19	6	0.3	0.15	2.240	0.940	0.395	6.61	7.8	60 000	80 000
707C	7	19	6	0.3	0.15	2.390	1.000	0.835	4.67	7.4	89 000	135 000
707A	7	19	6	0.3	0.15	2.240	0.940	0.375	6.61	7.4	58 000	77 000
708C	8	22	7	0.3	0.15	3.550	1.540	1.300	5.51	12.0	77 000	117 000
708A	8	22	7	0.3	0.15	3.350	1.450	1.020	7.84	12.0	50 000	67 000
728C	8	24	8	0.3	0.15	3.600	1.580	1.330	6.14	16.0	72 000	110 000
728A	8	24	8	0.3	0.15	3.350	1.480	0.610	8.62	16.0	47 000	63 000

(1) For permissible axial load, please refer to Page 147.

(2) For application of limiting speeds, please refer to Page 170. When a ceramic ball is used, limiting speed value will be 1.25 times the value of steel ball.

Note: Bearing numbers with a "C" suffix: nominal contact angle 15°

Bearing numbers with an "A" suffix: nominal contact angle 30°

High Precision Angular Contact Ball Bearings (BSA Series for ball screw support)

10 Series

Bore Diameter 8-15 mm

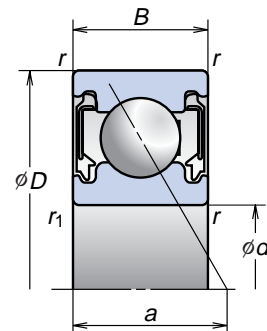

Bearing Numbers	Boundary Dimensions (mm)					Basic Load Ratings (kN)		Permissible Axial Load (1) (kN)	Effective Load Center (mm) a	Mass (g) (approx.)	Limiting Speeds (2) (min ⁻¹)
	d	D	B	r (min.)	r ₁ (min.)	C _r (Dynamic)	C _{0r} (Static)				Grease
8BSA10T1X	8	22	7	0.3	0.15	2.350	0.840	0.805	12.2	11.0	40 000
10BSA10T1X	10	26	8	0.3	0.15	3.250	1.200	0.960	14.4	16.6	33 300
12BSA10T1X	12	28	8	0.3	0.15	3.600	1.430	1.710	16.0	18.7	30 000
15BSA10T1X	15	32	9	0.3	0.15	3.900	1.690	1.950	18.6	27.7	25 500

(1) For permissible axial load, please refer to Page 147.

(2) For application of limiting speeds, please refer to Page 170. When a ceramic ball is used, limiting speed value will be 1.25 times the value of steel ball.

Note: Bearing type BSA: nominal contact angle 30°

High Precision Angular Contact Ball Bearings (Standard Series)

79 Series

Bore Diameter 10-55 mm

For additional information: Page No.

- Dynamic equivalent load139
- Static equivalent load146
- Preload and rigidity152
- Abutment and fillet dimensions186
- Nozzle position192
- Quantity of packed grease175

Bearing Numbers	Boundary Dimensions (mm)					Basic Load Ratings (kN)		Permissible Axial Load (1) (kN)	Factor f ₀	Effective Load Center (mm) a	Mass (kg) (approx.)	Sealed Design	Limiting Speeds (2) (min ⁻¹)	
	d	D	B	r (min.)	r ₁ (min.)	C _r (Dynamic)	C _{0r} (Static)						Grease	Oil
7900C	10	22	6	0.3	0.15	3.00	1.52	1.23	14.1	5.1	0.010	—	71 900	109 400
7900A5	10	22	6	0.3	0.15	2.88	1.45	1.44	—	6.7	0.009	—	62 500	93 800
7901C	12	24	6	0.3	0.15	3.35	1.86	1.45	14.7	5.4	0.011	—	63 900	97 300
7901A5	12	24	6	0.3	0.15	3.20	1.77	1.71	—	7.2	0.011	—	55 600	83 400
7902C	15	28	7	0.3	0.15	4.75	2.64	1.93	14.5	6.4	0.016	—	53 500	81 400
7902A5	15	28	7	0.3	0.15	4.55	2.53	2.22	—	8.5	0.016	—	46 600	69 800
7903C	17	30	7	0.3	0.15	5.00	2.94	2.09	14.8	6.6	0.017	—	49 000	74 500
7903A5	17	30	7	0.3	0.15	4.75	2.80	2.21	—	9.0	0.017	—	42 600	63 900
7904C	20	37	9	0.3	0.15	6.95	4.25	3.20	14.9	8.3	0.036	—	40 400	61 500
7904A5	20	37	9	0.3	0.15	6.60	4.05	3.55	—	11.1	0.037	—	35 100	52 700
7905C	25	42	9	0.3	0.15	7.85	5.40	3.90	15.5	9.0	0.043	—	34 400	52 300
7905A5	25	42	9	0.3	0.15	7.45	5.15	4.40	—	12.3	0.043	—	29 900	44 800
7906C	30	47	9	0.3	0.15	8.30	6.25	4.40	15.9	9.7	0.049	○	29 900	45 500
7906A5	30	47	9	0.3	0.15	7.85	5.95	4.95	—	13.5	0.050	○	26 000	39 000
7907C	35	55	10	0.6	0.3	12.1	9.15	6.60	15.7	11.0	0.074	○	25 600	38 900
7907A5	35	55	10	0.6	0.3	11.4	8.70	7.20	—	15.5	0.075	○	22 300	33 400
7908C	40	62	12	0.6	0.3	15.1	11.7	8.40	15.7	12.8	0.109	○	22 600	34 400
7908A5	40	62	12	0.6	0.3	14.3	11.2	8.90	—	17.9	0.110	○	19 700	29 500
7909C	45	68	12	0.6	0.3	16.0	13.4	8.55	16.0	13.6	0.129	○	20 400	31 000
7909A5	45	68	12	0.6	0.3	15.1	12.7	9.95	—	19.2	0.130	○	17 700	26 600
7910C	50	72	12	0.6	0.3	16.9	15.0	9.45	16.2	14.2	0.130	○	18 900	28 700
7910A5	50	72	12	0.6	0.3	15.9	14.2	11.0	—	20.2	0.132	○	16 400	24 600
7911C	55	80	13	1.0	0.6	19.1	17.7	11.0	16.3	15.5	0.182	○	17 100	26 000
7911A5	55	80	13	1.0	0.6	18.1	16.8	12.5	—	22.2	0.184	○	14 900	22 300

(1) For permissible axial load, please refer to Page 147.

(2) For application of limiting speeds, please refer to Page 170. When a ceramic ball is used, limiting speed value will be 1.25 times the value of steel ball.

Note: Bearing numbers with a "C" suffix: nominal contact angle 15°

Bearing numbers with an "A5" suffix: nominal contact angle 25°

1. ANGULAR CONTACT BALL BEARINGS

High Precision Angular Contact Ball Bearings (Standard Series)

79 Series

Bore Diameter 60-280 mm

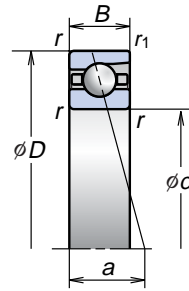

For additional information: Page No.

- Dynamic equivalent load139
- Static equivalent load146
- Preload and rigidity152
- Abutment and fillet dimensions186
- Nozzle position192
- Quantity of packed grease175

Bearing Numbers	Boundary Dimensions (mm)					Basic Load Ratings (kN)		Permissible Axial Load (1) (kN)	Factor f ₀	Effective Load Center (mm) a	Mass (kg) (approx.)	Sealed Design	Limiting Speeds (2) (min ⁻¹)	
	d	D	B	r (min.)	r ₁ (min.)	C _r (Dynamic)	C _{0r} (Static)						Grease	Oil
7912C	60	85	13	1.0	0.6	19.4	18.7	11.5	16.5	16.2	0.195	○	15 900	24 200
7912A5	60	85	13	1.0	0.6	18.3	17.7	13.0	—	23.4	0.198	○	13 800	20 700
7913C	65	90	13	1.0	0.6	20.2	20.5	12.5	16.7	16.9	0.208	○	14 900	22 600
7913A5	65	90	13	1.0	0.6	19.1	19.4	14.2	—	24.6	0.211	○	13 000	19 400
7914C	70	100	16	1.0	0.6	28.1	27.8	17.3	16.4	19.4	0.338	○	13 600	20 600
7914A5	70	100	16	1.0	0.6	26.5	26.3	20.3	—	27.8	0.341	○	11 800	17 700
7915C	75	105	16	1.0	0.6	28.6	29.3	18.0	16.6	20.1	0.358	○	12 800	19 500
7915A5	75	105	16	1.0	0.6	26.9	27.7	21.2	—	29.0	0.355	○	11 200	16 700
7916C	80	110	16	1.0	0.6	29.0	30.5	18.7	16.7	20.7	0.377	○	12 200	18 500
7916A5	80	110	16	1.0	0.6	27.3	29.0	22.1	—	30.2	0.381	○	10 600	15 800
7917C	85	120	18	1.1	0.6	39.0	40.5	25.9	16.5	22.7	0.534	○	11 300	17 100
7917A5	85	120	18	1.1	0.6	36.5	38.5	30.0	—	32.9	0.541	○	9 800	14 700
7918C	90	125	18	1.1	0.6	41.5	46.0	29.1	16.6	23.4	0.568	○	10 700	16 300
7918A5	90	125	18	1.1	0.6	39.5	43.5	33.5	—	34.1	0.560	○	9 400	14 000
7919C	95	130	18	1.1	0.6	42.5	48.0	30.0	16.7	24.1	0.597	○	10 300	15 600
7919A5	95	130	18	1.1	0.6	40.0	45.5	35.0	—	35.2	0.603	○	8 900	13 400
7920C	100	140	20	1.1	0.6	50.0	54.0	33.0	16.5	26.1	0.800	○	9 600	14 600
7920A5	100	140	20	1.1	0.6	47.5	51.5	39.5	—	38.0	0.808	○	8 400	12 500
7921C	105	145	20	1.1	0.6	51.0	57.0	34.5	16.6	26.7	0.831	—	9 200	14 000
7921A5	105	145	20	1.1	0.6	48.0	54.0	41.0	—	39.2	0.820	—	8 000	12 000
7922C	110	150	20	1.1	0.6	52.0	59.5	35.5	16.7	27.4	0.867	—	8 900	13 500
7922A5	110	150	20	1.1	0.6	49.0	56.0	43.0	—	40.3	0.877	—	7 700	11 600
7924C	120	165	22	1.1	0.6	72.0	81.0	50.5	16.5	30.1	1.160	—	8 100	12 300
7924A5	120	165	22	1.1	0.6	67.5	77.0	59.5	—	44.2	1.150	—	7 100	10 600

(1) For permissible axial load, please refer to Page 147.
 (2) For application of limiting speeds, please refer to Page 170.
 When a ceramic ball is used, limiting speed value will be 1.25 times the value of steel ball.
Note: Bearing numbers with a "C" suffix: nominal contact angle 15°
 Bearing numbers with an "A5" suffix: nominal contact angle 25°

79 Series (continued)

Bearing Numbers	Boundary Dimensions (mm)					Basic Load Ratings (kN)		Permissible Axial Load (1) (kN)	Factor f ₀	Effective Load Center (mm) a	Mass (kg) (approx.)	Sealed Design	Limiting Speeds (2) (min ⁻¹)	
	d	D	B	r (min.)	r ₁ (min.)	C _r (Dynamic)	C _{0r} (Static)						Grease	Oil
7926C	130	180	24	1.5	1.0	78.5	91.0	55.0	16.5	32.8	1.500	—	7 500	11 300
7926A5	130	180	24	1.5	1.0	74.0	86.0	63.5	—	48.1	1.540	—	6 500	9 700
7928C	140	190	24	1.5	1.0	79.5	95.5	58.0	16.7	34.1	1.630	—	7 000	10 700
7928A5	140	190	24	1.5	1.0	75.0	90.0	68.0	—	50.5	1.630	—	6 100	9 100
7930C	150	210	28	2.0	1.0	102	122	74.0	16.6	38.1	2.960	—	6 400	9 800
7930A5	150	210	28	2.0	1.0	96.5	115	84.5	—	56.0	2.970	—	5 600	8 400
7932C	160	220	28	2.0	1.0	106	133	80.0	16.7	39.4	3.100	—	6 100	9 300
7932A5	160	220	28	2.0	1.0	100	125	93.5	—	58.3	3.120	—	5 300	7 900
7934C	170	230	28	2.0	1.0	113	148	88.5	16.8	40.8	3.360	—	5 800	8 800
7934A5	170	230	28	2.0	1.0	106	140	103	—	60.6	3.360	—	5 000	7 500
7936C	180	250	33	2.0	1.0	145	184	111	16.6	45.3	4.900	—	5 400	8 200
7936A5	180	250	33	2.0	1.0	137	174	127	—	66.6	4.940	—	4 700	7 000
7938C	190	260	33	2.0	1.0	147	192	115	16.7	46.6	4.980	—	5 200	7 800
7938A5	190	260	33	2.0	1.0	139	182	131	—	69.0	5.120	—	4 500	6 700
7940C	200	280	38	2.1	1.1	189	244	144	16.5	51.2	6.850	—	4 800	7 300
7940A5	200	280	38	2.1	1.1	178	231	169	—	75.0	6.920	—	4 200	6 300
7944C	220	300	38	2.1	1.1	190	256	235	16.7	53.8	6.665	—	4 500	6 800
7944A5	220	300	38	2.1	1.1	179	242	174	—	79.6	6.665	—	3 900	5 800
7948C	240	320	38	2.1	1.1	200	286	260	16.8	56.5	7.224	—	4 200	6 300
7948A5	240	320	38	2.1	1.1	189	270	193	—	84.3	7.224	—	3 600	5 400
7952C	260	360	46	2.1	1.1	256	365	340	16.6	64.5	11.936	—	3 800	5 700
7952A5	260	360	46	2.1	1.1	241	345	252	—	95.3	11.936	—	3 300	4 900
7956C	280	380	46	2.1	1.1	272	410	380	16.7	67.2	12.853	—	3 500	5 400
7956A5	280	380	46	2.1	1.1	256	390	283	—	99.9	12.853	—	3 100	4 600

(1) For permissible axial load, please refer to Page 147.
 (2) For application of limiting speeds, please refer to Page 170.
Note: Bearing numbers with a "C" suffix: nominal contact angle 15°
 Bearing numbers with an "A5" suffix: nominal contact angle 25°

1. ANGULAR CONTACT BALL BEARINGS

High Precision Angular Contact Ball Bearings (Standard Series)

70 Series

Bore Diameter 10-75 mm

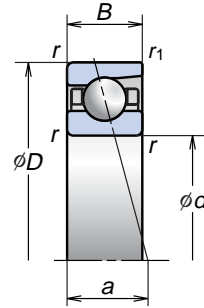

- For additional information: Page No.
- Dynamic equivalent load139
 - Static equivalent load146
 - Preload and rigidity152
 - Abutment and fillet dimensions186
 - Nozzle position192
 - Quantity of packed grease175

Bearing Numbers	Boundary Dimensions (mm)					Basic Load Ratings (kN)		Permissible Axial Load (1) (kN)	Factor f ₀	Effective Load Center (mm) a	Mass (kg) (approx.)	Sealed Design	Limiting Speeds (2) (min ⁻¹)	
	d	D	B	r (min.)	r ₁ (min.)	C _r (Dynamic)	C _{0r} (Static)						Grease	Oil
7000C	10	26	8	0.3	0.15	5.30	2.49	2.16	12.6	6.4	0.019	—	63 900	97 300
7000A5	10	26	8	0.3	0.15	5.15	2.41	2.48	—	8.2	0.019	—	55 600	83 400
7000A	10	26	8	0.3	0.15	5.00	2.34	1.91	—	9.2	0.019	—	41 700	55 600
7001C	12	28	8	0.3	0.15	5.80	2.90	2.40	13.2	6.7	0.021	—	57 500	87 500
7001A5	12	28	8	0.3	0.15	5.60	2.79	2.82	—	8.7	0.021	—	50 000	75 000
7001A	12	28	8	0.3	0.15	5.40	2.71	2.13	—	9.8	0.021	—	37 500	50 000
7002C	15	32	9	0.3	0.15	6.25	3.40	2.63	14.1	7.6	0.030	—	49 000	74 500
7002A5	15	32	9	0.3	0.15	5.95	3.25	3.05	—	10.0	0.030	—	42 600	63 900
7002A	15	32	9	0.3	0.15	5.80	3.15	2.36	—	11.3	0.030	—	32 000	42 600
7003C	17	35	10	0.3	0.15	6.60	3.80	2.85	14.5	8.5	0.039	—	44 300	67 400
7003A5	17	35	10	0.3	0.15	6.30	3.65	3.35	—	11.1	0.040	—	38 500	57 700
7003A	17	35	10	0.3	0.15	6.10	3.50	2.59	—	12.5	0.040	—	28 900	38 500
7004C	20	42	12	0.6	0.3	11.1	6.55	4.80	14.0	10.1	0.067	—	37 100	56 500
7004A5	20	42	12	0.6	0.3	10.6	6.25	5.45	—	13.2	0.067	—	32 300	48 400
7004A	20	42	12	0.6	0.3	10.3	6.10	4.20	—	14.9	0.068	—	24 200	32 300
7005C	25	47	12	0.6	0.3	11.7	7.40	5.20	14.7	10.8	0.078	—	32 000	48 700
7005A5	25	47	12	0.6	0.3	11.1	7.10	5.95	—	14.4	0.077	—	27 800	41 700
7005A	25	47	12	0.6	0.3	10.7	6.85	4.55	—	16.4	0.079	—	20 900	27 800
7006C	30	55	13	1.0	0.6	15.1	10.3	6.85	14.9	12.2	0.114	○	27 100	41 200
7006A5	30	55	13	1.0	0.6	14.4	9.80	8.05	—	16.4	0.114	○	23 600	35 300
7006A	30	55	13	1.0	0.6	13.9	9.45	6.20	—	18.8	0.116	○	17 700	23 600
7007C	35	62	14	1.0	0.6	19.1	13.7	9.35	15.0	13.5	0.151	○	23 800	36 100
7007A5	35	62	14	1.0	0.6	18.2	13.0	11.4	—	18.3	0.151	○	20 700	31 000
7007A	35	62	14	1.0	0.6	17.5	12.6	8.75	—	21.0	0.153	○	15 500	20 700

(1) For permissible axial load, please refer to Page 147.

(2) For application of limiting speeds, please refer to Page 170.

When a ceramic ball is used, limiting speed value will be 1.25 times the value of steel ball.

Note: Bearing numbers with a "C" suffix: nominal contact angle 15°
 Bearing numbers with an "A5" suffix: nominal contact angle 25°
 Bearing numbers with an "A" suffix: nominal contact angle 30°

70 Series (continued)

Bearing Numbers	Boundary Dimensions (mm)					Basic Load Ratings (kN)		Permissible Axial Load (1) (kN)	Factor f ₀	Effective Load Center (mm) a	Mass (kg) (approx.)	Sealed Design	Limiting Speeds (2) (min ⁻¹)	
	d	D	B	r (min.)	r ₁ (min.)	C _r (Dynamic)	C _{0r} (Static)						Grease	Oil
7008C	40	68	15	1.0	0.6	20.6	15.9	10.6	15.4	14.7	0.189	○	21 300	32 500
7008A5	40	68	15	1.0	0.6	19.5	15.1	12.0	—	20.1	0.188	○	18 600	27 800
7008A	40	68	15	1.0	0.6	18.8	14.6	9.15	—	23.1	0.191	○	13 900	18 600
7009C	45	75	16	1.0	0.6	24.4	19.3	12.4	15.4	16.0	0.238	○	19 200	29 200
7009A5	45	75	16	1.0	0.6	23.1	18.3	14.5	—	22.0	0.250	○	16 700	25 000
7009A	45	75	16	1.0	0.6	22.3	17.7	11.1	—	25.3	0.241	○	12 500	16 700
7010C	50	80	16	1.0	0.6	26.0	21.9	13.9	15.7	16.7	0.259	○	17 700	27 000
7010A5	50	80	16	1.0	0.6	24.6	20.8	16.2	—	23.2	0.270	○	15 400	23 100
7010A	50	80	16	1.0	0.6	23.7	20.1	12.5	—	26.8	0.262	○	11 600	15 400
7011C	55	90	18	1.1	0.6	34.0	28.6	18.9	15.5	18.7	0.380	○	15 900	24 200
7011A5	55	90	18	1.1	0.6	32.5	27.2	21.8	—	25.9	0.383	○	13 800	20 700
7011A	55	90	18	1.1	0.6	31.0	26.3	16.6	—	29.9	0.385	○	10 400	13 800
7012C	60	95	18	1.1	0.6	35.0	30.5	19.9	15.7	19.4	0.405	○	14 900	22 600
7012A5	60	95	18	1.1	0.6	33.0	29.1	23.0	—	27.1	0.408	○	13 000	19 400
7012A	60	95	18	1.1	0.6	32.0	28.1	17.6	—	31.4	0.410	○	9 700	13 000
7013C	65	100	18	1.1	0.6	37.0	34.5	22.0	15.9	20.0	0.435	○	14 000	21 300
7013A5	65	100	18	1.1	0.6	35.0	32.5	25.4	—	28.2	0.455	○	12 200	18 200
7013A	65	100	18	1.1	0.6	33.5	31.5	19.5	—	32.8	0.441	○	9 100	12 200
7014C	70	110	20	1.1	0.6	47.0	43.0	26.8	15.7	22.1	0.606	○	12 800	19 500
7014A5	70	110	20	1.1	0.6	44.5	41.0	32.0	—	31.0	0.625	○	11 200	16 700
7014A	70	110	20	1.1	0.6	42.5	39.5	24.6	—	36.0	0.613	○	8 400	11 200
7015C	75	115	20	1.1	0.6	48.0	45.5	28.1	15.9	22.7	0.643	○	12 200	18 500
7015A5	75	115	20	1.1	0.6	45.5	43.5	33.5	—	32.1	0.652	○	10 600	15 800
7015A	75	115	20	1.1	0.6	43.5	41.5	25.9	—	37.4	0.650	○	7 900	10 600

(1) For permissible axial load, please refer to Page 147.

(2) For application of limiting speeds, please refer to Page 170.

When a ceramic ball is used, limiting speed value will be 1.25 times the value of steel ball.

Note: Bearing numbers with a "C" suffix: nominal contact angle 15°
 Bearing numbers with an "A5" suffix: nominal contact angle 25°
 Bearing numbers with an "A" suffix: nominal contact angle 30°

1. ANGULAR CONTACT BALL BEARINGS

High Precision Angular Contact Ball Bearings (Standard Series)

70 Series

Bore Diameter 80-200 mm

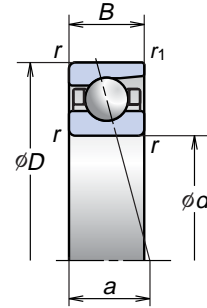

- For additional information: Page No.
- Dynamic equivalent load139
 - Static equivalent load146
 - Preload and rigidity152
 - Abutment and fillet dimensions186
 - Nozzle position192
 - Quantity of packed grease175

Bearing Numbers	Boundary Dimensions (mm)					Basic Load Ratings (kN)		Permissible Axial Load (1) (kN)	Factor f ₀	Effective Load Center (mm) a	Mass (kg) (approx.)	Sealed Design	Limiting Speeds (2) (min ⁻¹)	
	d	D	B	r (min.)	r ₁ (min.)	C _r (Dynamic)	C _{0r} (Static)						Grease	Oil
7016C	80	125	22	1.1	0.6	58.5	55.5	34.5	15.7	24.7	0.855	○	11 300	17 100
7016A5	80	125	22	1.1	0.6	55.5	52.5	41.0	—	34.9	0.880	○	9 800	14 700
7016A	80	125	22	1.1	0.6	53.5	50.5	31.5	—	40.6	0.864	○	7 400	9 800
7017C	85	130	22	1.1	0.6	60.0	58.5	38.0	15.9	25.4	0.898	○	10 700	16 300
7017A5	85	130	22	1.1	0.6	57.0	55.5	43.0	—	36.1	0.904	○	9 400	14 000
7017A	85	130	22	1.1	0.6	54.5	53.5	33.0	—	42.0	0.907	○	7 000	9 400
7018C	90	140	24	1.5	1.0	71.5	69.0	44.5	15.7	27.4	1.160	○	10 000	15 300
7018A5	90	140	24	1.5	1.0	68.0	65.5	52.0	—	38.8	1.170	○	8 700	13 100
7018A	90	140	24	1.5	1.0	65.0	63.5	40.5	—	45.2	1.180	○	6 600	8 700
7019C	95	145	24	1.5	1.0	73.5	73.0	47.0	15.9	28.1	1.210	○	9 600	14 600
7019A5	95	145	24	1.5	1.0	69.5	69.5	52.5	—	40.0	1.410	○	8 400	12 500
7019A	95	145	24	1.5	1.0	67.0	67.0	40.5	—	46.6	1.230	○	6 300	8 400
7020C	100	150	24	1.5	1.0	75.5	77.0	49.0	16.0	28.7	1.270	○	9 200	14 000
7020A5	100	150	24	1.5	1.0	71.0	73.5	57.5	—	41.1	1.450	○	8 000	12 000
7020A	100	150	24	1.5	1.0	68.5	70.5	44.5	—	48.1	1.280	○	6 000	8 000
7021C	105	160	26	2.0	1.0	88.0	89.5	57.0	15.9	30.7	1.580	—	8 700	13 300
7021A5	105	160	26	2.0	1.0	83.5	85.0	66.5	—	43.9	1.820	—	7 600	11 400
7021A	105	160	26	2.0	1.0	80.0	81.5	51.0	—	51.2	1.600	—	5 700	7 600
7022C	110	170	28	2.0	1.0	106	104	68.5	15.6	32.7	1.940	—	8 300	12 500
7022A5	110	170	28	2.0	1.0	100	99.0	79.5	—	46.6	2.260	—	7 200	10 800
7022A	110	170	28	2.0	1.0	96.5	95.5	61.0	—	54.4	1.960	—	5 400	7 200
7024C	120	180	28	2.0	1.0	112	117	75.5	15.8	34.1	2.090	—	7 700	11 700
7024A5	120	180	28	2.0	1.0	106	111	87.5	—	49.0	2.430	—	6 700	10 000
7024A	120	180	28	2.0	1.0	102	107	67.5	—	57.3	2.120	—	5 000	6 700

(1) For permissible axial load, please refer to Page 147.
 (2) For application of limiting speeds, please refer to Page 170.
 When a ceramic ball is used, limiting speed value will be 1.25 times the value of steel ball.
Note: Bearing numbers with a "C" suffix: nominal contact angle 15°
 Bearing numbers with an "A5" suffix: nominal contact angle 25°
 Bearing numbers with an "A" suffix: nominal contact angle 30°

70 Series (continued)

Bearing Numbers	Boundary Dimensions (mm)					Basic Load Ratings (kN)		Permissible Axial Load (1) (kN)	Factor f ₀	Effective Load Center (mm) a	Mass (kg) (approx.)	Sealed Design	Limiting Speeds (2) (min ⁻¹)	
	d	D	B	r (min.)	r ₁ (min.)	C _r (Dynamic)	C _{0r} (Static)						Grease	Oil
7026C	130	200	33	2.0	1.0	129	137	86.0	15.9	38.6	3.220	—	7 000	10 700
7026A5	130	200	33	2.0	1.0	122	130	99.5	—	55.0	3.660	—	6 100	9 100
7026A	130	200	33	2.0	1.0	117	125	76.5	—	64.1	3.260	—	4 600	6 100
7028C	140	210	33	2.0	1.0	132	145	90.0	16.0	39.9	3.410	—	6 600	10 000
7028A5	140	210	33	2.0	1.0	125	138	104	—	57.3	3.870	—	5 800	8 600
7028A	140	210	33	2.0	1.0	120	133	80.5	—	67.0	3.440	—	4 300	5 800
7030C	150	225	35	2.1	1.1	151	168	105	16.0	42.6	4.150	—	6 200	9 400
7030A5	150	225	35	2.1	1.1	143	160	123	—	61.2	4.690	—	5 400	8 000
7030A	150	225	35	2.1	1.1	137	154	95.0	—	71.6	4.190	—	4 000	5 400
7032C	160	240	38	2.1	1.1	171	193	118	16.0	45.8	5.110	—	5 800	8 800
7032A5	160	240	38	2.1	1.1	162	183	138	—	65.6	5.710	—	5 000	7 500
7032A	160	240	38	2.1	1.1	155	176	106	—	76.7	5.160	—	3 800	5 000
7034C	170	260	42	2.1	1.1	205	234	149	15.9	49.8	6.880	—	5 400	8 200
7034A5	170	260	42	2.1	1.1	193	223	168	—	71.1	7.830	—	4 700	7 000
7034A	170	260	42	2.1	1.1	186	214	129	—	83.1	6.940	—	3 500	4 700
7036C	180	280	46	2.1	1.1	228	276	175	15.8	53.8	10.40	—	5 000	7 700
7036A5	180	280	46	2.1	1.1	216	262	195	—	76.6	10.40	—	4 400	6 600
7036A	180	280	46	2.1	1.1	207	252	151	—	89.4	9.270	—	3 300	4 400
7038C	190	290	46	2.1	1.1	247	305	192	15.9	55.2	11.20	—	4 800	7 300
7038A5	190	290	46	2.1	1.1	233	291	222	—	79.0	11.20	—	4 200	6 300
7038A	190	290	46	2.1	1.1	224	280	172	—	92.3	11.30	—	3 200	4 200
7040C	200	310	51	2.1	1.1	265	340	213	15.9	59.7	13.60	—	4 600	6 900
7040A5	200	310	51	2.1	1.1	250	325	245	—	85.0	13.70	—	4 000	5 900
7040A	200	310	51	2.1	1.1	240	310	190	—	99.1	13.70	—	3 000	4 000

(1) For permissible axial load, please refer to Page 14.
 (2) For application of limiting speeds, please refer to Page 170.
Note: Bearing numbers with a "C" suffix: nominal contact angle 15°
 Bearing numbers with an "A5" suffix: nominal contact angle 25°
 Bearing numbers with an "A" suffix: nominal contact angle 30°

1. ANGULAR CONTACT BALL BEARINGS

High Precision Angular Contact Ball Bearings (Standard Series)

72 Series

Bore Diameter 10-105 mm

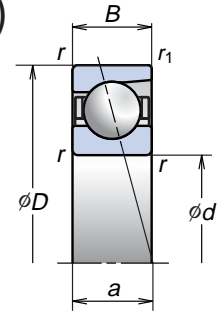

- For additional information: Page No.
- Dynamic equivalent load139
 - Static equivalent load146
 - Preload and rigidity152
 - Abutment and fillet dimensions186
 - Nozzle position192
 - Quantity of packed grease175

Bearing Numbers	Boundary Dimensions (mm)					Basic Load Ratings (kN)		Permissible Axial Load ⁽¹⁾ (kN)	Factor f_0	Effective Load Center (mm) a	Mass (kg) (approx.)	Limiting Speeds ⁽²⁾ (min ⁻¹)	
	d	D	B	r (min.)	r_1 (min.)	C_r (Dynamic)	C_{0r} (Static)					Grease	Oil
7200C	10	30	9	0.6	0.3	5.40	2.61	2.16	13.2	7.2	0.032	57 500	87 500
7200A5	10	30	9	0.6	0.3	5.20	2.51	2.49	—	9.2	0.031	50 000	75 000
7200A	10	30	9	0.6	0.3	5.05	2.44	1.92	—	10.3	0.032	37 500	50 000
7201C	12	32	10	0.6	0.3	7.90	3.85	3.45	12.5	7.9	0.036	52 300	79 600
7201A5	12	32	10	0.6	0.3	7.65	3.70	3.55	—	10.1	0.036	45 500	68 200
7201A	12	32	10	0.6	0.3	7.45	3.65	2.72	—	11.4	0.030	34 100	45 500
7202C	15	35	11	0.6	0.3	8.65	4.55	3.85	13.2	8.8	0.045	46 000	70 000
7202A5	15	35	11	0.6	0.3	8.35	4.35	3.95	—	11.3	0.044	40 000	60 000
7202A	15	35	11	0.6	0.3	8.10	4.25	3.00	—	12.7	0.045	30 000	40 000
7203C	17	40	12	0.6	0.3	10.9	5.85	4.85	13.3	9.8	0.065	40 400	61 500
7203A5	17	40	12	0.6	0.3	10.4	5.60	5.30	—	12.6	0.064	35 100	52 700
7203A	17	40	12	0.6	0.3	10.1	5.45	4.05	—	14.2	0.065	26 400	35 100
7204C	20	47	14	1.0	0.6	14.6	8.05	6.30	13.3	11.5	0.103	34 400	52 300
7204A5	20	47	14	1.0	0.6	14.0	7.75	7.40	—	14.8	0.102	29 900	44 800
7204A	20	47	14	1.0	0.6	13.6	7.55	5.75	—	16.7	0.104	22 400	29 900
7205C	25	52	15	1.0	0.6	16.6	10.2	7.50	14.0	12.7	0.127	29 900	45 500
7205A5	25	52	15	1.0	0.6	15.9	9.80	9.05	—	16.5	0.130	26 000	39 000
7205A	25	52	15	1.0	0.6	15.4	9.45	6.95	—	18.6	0.129	19 500	26 000
7206C	30	62	16	1.0	0.6	23.0	14.7	10.3	13.9	14.2	0.194	25 000	38 100
7206A5	30	62	16	1.0	0.6	22.1	14.1	12.0	—	18.7	0.194	21 800	32 700
7206A	30	62	16	1.0	0.6	21.3	13.6	9.20	—	21.3	0.197	16 400	21 800
7207C	35	72	17	1.1	0.6	30.5	19.9	14.4	13.9	15.7	0.280	21 500	32 800
7207A5	35	72	17	1.1	0.6	29.1	19.1	16.6	—	21.0	0.277	18 700	28 100
7207A	35	72	17	1.1	0.6	28.2	18.5	12.7	—	23.9	0.284	14 100	18 700
7208C	40	80	18	1.1	0.6	36.5	25.2	17.6	14.1	17.0	0.366	19 200	29 200
7208A5	40	80	18	1.1	0.6	34.5	24.1	20.6	—	23.0	0.362	16 700	25 000
7208A	40	80	18	1.1	0.6	33.5	23.3	15.8	—	26.3	0.370	12 500	16 700
7209C	45	85	19	1.1	0.6	41.0	28.8	19.6	14.2	18.2	0.406	17 700	27 000
7209A5	45	85	19	1.1	0.6	39.0	27.6	23.3	—	24.7	0.402	15 400	23 100
7209A	45	85	19	1.1	0.6	37.5	26.7	18.0	—	28.3	0.410	11 600	15 400
7210C	50	90	20	1.1	0.6	43.0	31.5	21.1	14.5	19.4	0.457	16 500	25 000
7210A5	50	90	20	1.1	0.6	41.0	30.5	25.2	—	26.3	0.453	14 300	21 500
7210A	50	90	20	1.1	0.6	39.5	29.3	19.4	—	30.2	0.462	10 800	14 300

⁽¹⁾ For permissible axial load, please refer to Page 147.
⁽²⁾ For application of limiting speeds, please refer to Page 170.
 Note: Bearing numbers with a "C" suffix: nominal contact angle 15°
 Bearing numbers with an "A5" suffix: nominal contact angle 25°
 Bearing numbers with an "A" suffix: nominal contact angle 30°

72 Series (continued)

Bearing Numbers	Boundary Dimensions (mm)					Basic Load Ratings (kN)		Permissible Axial Load ⁽¹⁾ (kN)	Factor f_0	Effective Load Center (mm) a	Mass (kg) (approx.)	Limiting Speeds ⁽²⁾ (min ⁻¹)	
	d	D	B	r (min.)	r_1 (min.)	C_r (Dynamic)	C_{0r} (Static)					Grease	Oil
7211C	55	100	21	1.5	1.0	53.0	40.0	27.6	14.5	20.9	0.601	14 900	22 600
7211A5	55	100	21	1.5	1.0	50.5	38.0	32.5	—	28.6	0.596	13 000	19 400
7211A	55	100	21	1.5	1.0	49.0	37.0	25.0	—	32.9	0.609	9 700	13 000
7212C	60	110	22	1.5	1.0	64.0	49.0	34.0	14.4	22.4	0.780	13 600	20 600
7212A5	60	110	22	1.5	1.0	61.0	47.0	40.0	—	30.8	0.773	11 800	17 700
7212A	60	110	22	1.5	1.0	59.0	45.5	30.5	—	35.5	0.789	8 900	11 800
7213C	65	120	23	1.5	1.0	73.0	58.5	40.0	14.6	23.9	1.010	12 500	19 000
7213A5	65	120	23	1.5	1.0	69.5	56.0	46.5	—	33.1	1.000	10 900	16 300
7213A	65	120	23	1.5	1.0	67.5	54.0	36.0	—	38.2	1.020	8 200	10 900
7214C	70	125	24	1.5	1.0	79.5	64.5	43.0	14.6	25.1	1.090	11 800	18 000
7214A5	70	125	24	1.5	1.0	76.0	61.5	49.5	—	34.7	1.080	10 300	15 400
7214A	70	125	24	1.5	1.0	73.0	59.5	38.0	—	40.1	1.100	7 700	10 300
7215C	75	130	25	1.5	1.0	83.0	70.0	46.0	14.8	26.2	1.190	11 300	17 100
7215A5	75	130	25	1.5	1.0	79.0	66.5	53.0	—	36.4	1.180	9 800	14 700
7215A	75	130	25	1.5	1.0	76.0	64.5	40.5	—	42.1	1.200	7 400	9 800
7216C	80	140	26	2.0	1.0	93.0	77.5	54.5	14.7	27.7	1.430	10 500	16 000
7216A5	80	140	26	2.0	1.0	88.5	74.0	62.0	—	38.6	1.420	9 100	13 700
7216A	80	140	26	2.0	1.0	85.5	71.5	47.5	—	44.8	1.450	6 900	9 100
7217C	85	150	28	2.0	1.0	107	90.5	60.5	14.7	29.7	1.790	9 800	14 900
7217A5	85	150	28	2.0	1.0	102	86.5	70.0	—	41.4	1.790	8 600	12 800
7217A	85	150	28	2.0	1.0	98.5	83.5	53.5	—	47.9	1.800	6 400	8 600
7218C	90	160	30	2.0	1.0	123	105	72.0	14.6	31.7	2.200	9 200	14 000
7218A5	90	160	30	2.0	1.0	117	100	83.5	—	44.1	2.310	8 000	12 000
7218A	90	160	30	2.0	1.0	113	96.5	64.5	—	51.1	2.230	6 000	8 000
7219C	95	170	32	2.1	1.1	133	112	76.0	14.6	33.7	2.640	8 700	13 300
7219A5	95	170	32	2.1	1.1	127	107	87.0	—	46.9	2.630	7 600	11 400
7219A	95	170	32	2.1	1.1	122	103	67.0	—	54.2	2.670	5 700	7 600
7220C	100	180	34	2.1	1.1	149	127	88.5	14.5	35.7	3.180	8 300	12 500
7220A5	100	180	34	2.1	1.1	142	121	103	—	49.6	3.160	7 200	10 800
7220A	100	180	34	2.1	1.1	137	117	79.5	—	57.4	3.210	5 400	7 200
7221C	105	190	36	2.1	1.1	162	143	97.5	14.5	37.7	3.780	7 800	11 900
7221A5	105	190	36	2.1	1.1	155	137	111	—	52.4	3.770	6 800	10 200
7221A	105	190	36	2.1	1.1	150	132	85.0	—	60.6	3.820	5 100	6 800

⁽¹⁾ For permissible axial load, please refer to Page 147.
⁽²⁾ For application of limiting speeds, please refer to Page 170.
 Note: Bearing numbers with a "C" suffix: nominal contact angle 15°
 Bearing numbers with an "A5" suffix: nominal contact angle 25°
 Bearing numbers with an "A" suffix: nominal contact angle 30°

1. ANGULAR CONTACT BALL BEARINGS

High Precision Angular Contact Ball Bearings (Standard Series)

72 Series

Bore Diameter 110-150 mm

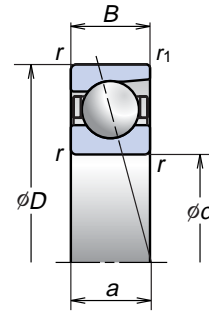

Bearing Numbers	Boundary Dimensions (mm)					Basic Load Ratings (kN)		Permissible Axial Load ⁽¹⁾ (kN)	Factor f_0	Effective Load Center (mm) a	Mass (kg) (approx.)	Limiting Speeds ⁽²⁾ (min ⁻¹)	
	d	D	B	r (min.)	r_1 (min.)	C_r (Dynamic)	C_{0r} (Static)					Grease	Oil
7222C	110	200	38	2.1	1.1	176	160	108	14.5	39.8	4.450	7 500	11 300
7222A5	110	200	38	2.1	1.1	168	153	126	–	55.1	4.450	6 500	9 700
7222A	110	200	38	2.1	1.1	162	148	97.0	–	63.7	4.490	4 900	6 500
7224C	120	215	40	2.1	1.1	199	192	132	14.6	42.4	5.420	6 900	10 500
7224A5	120	215	40	2.1	1.1	189	184	150	–	59.1	5.420	6 000	9 000
7224A	120	215	40	2.1	1.1	183	177	116	–	68.3	5.450	4 500	6 000
7226C	130	230	40	3.0	1.1	206	209	144	14.9	44.1	6.230	6 400	9 800
7226A5	130	230	40	3.0	1.1	196	199	163	–	62.0	6.220	5 600	8 400
7226A	130	230	40	3.0	1.1	189	193	127	–	72.0	6.280	4 200	5 600
7228C	140	250	42	3.0	1.1	238	254	172	14.8	47.1	7.910	5 900	9 000
7228A5	140	250	42	3.0	1.1	226	242	194	–	66.5	7.910	5 200	7 700
7228A	140	250	42	3.0	1.1	218	234	150	–	77.3	7.970	3 900	5 200
7230C	150	270	45	3.0	1.1	270	305	205	14.7	50.6	11.100	5 500	8 400
7230A5	150	270	45	3.0	1.1	258	290	231	–	71.5	11.100	4 800	7 200
7230A	150	270	45	3.0	1.1	248	280	179	–	83.1	11.200	3 600	4 800

⁽¹⁾ For permissible axial load, please refer to Page 147.

⁽²⁾ For application of limiting speeds, please refer to Page 170.

Note: Bearing numbers with a "C" suffix: nominal contact angle 15°
 Bearing numbers with an "A5" suffix: nominal contact angle 25°
 Bearing numbers with an "A" suffix: nominal contact angle 30°

1. ANGULAR CONTACT BALL BEARINGS

Ultra High-Speed Angular Contact Ball Bearings (ROBUST Series)

Features

Optimum Design

Robust design achieved with NSK's proprietary analytical technology.
Optimum design achieved by computer simulation of temperature rise resulting from ball skid.

Long Life

New SHX steel material provides superior heat and wear resistance.
Enhanced service life measures include raising the seizure limit under low lubrication and high-speed operating conditions.

High Accuracy

Rolling element material can be tailored to match the application.
Ceramic balls are used for ROBUST series angular contact ball bearings.
Highly accurate P2 series is available.
NSK's experience and know-how ensure bearing specifications with a high degree of accuracy.

High Speed

Cage engineered for high-speed operations.
Benefits of the lightweight, high strength engineered resin cage include heat resistance and high rigidity, making this cage indispensable for high-speed applications.

Low Noise

Quieter running high-speed spindle featuring Spinshot™ II lubrication system.
Eliminates noise caused by compressed air of the oil-air lubrication system.

Dimension Series

Fig. 1.4

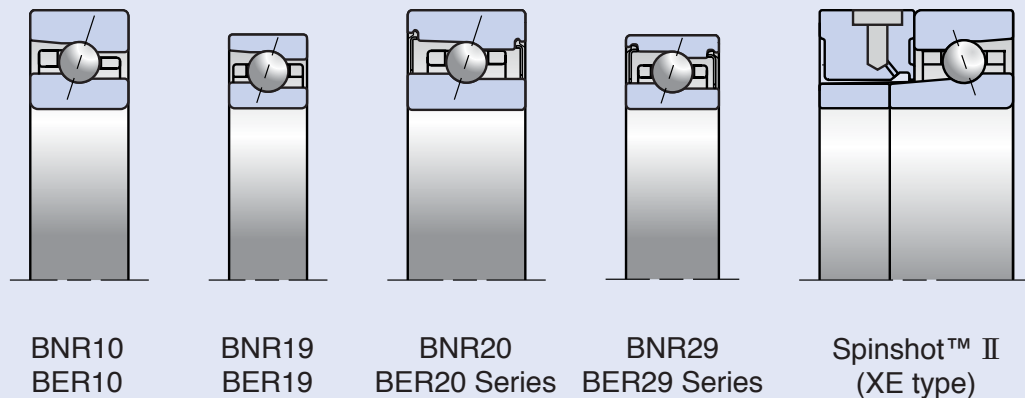

Numbering System of Ultra High-Speed Angular Contact Ball Bearings (ROBUST Series)

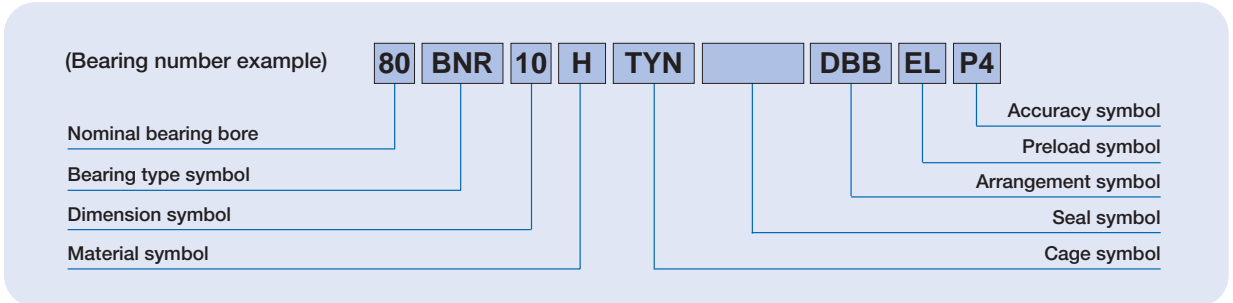

			Reference pages																	
80	Nominal bearing bore	Bore diameter (mm)	64-79																	
BNR	Bearing type	BNR: 18° contact angle, BER: 25° contact angle	42-43, 48																	
10	Dimension	10: 10 series, 19: 19 series, 20: 20 series, 29: 29 series (*)	42-43, 62																	
H	Material	<table border="1"> <thead> <tr> <th rowspan="2">Type</th> <th colspan="2">Material</th> </tr> <tr> <th>Rings</th> <th>Rolling elements</th> </tr> </thead> <tbody> <tr> <td>S</td> <td>Bearing steel (SUJ2)</td> <td>Bearing steel (SUJ2)</td> </tr> <tr> <td>H</td> <td>Bearing steel (SUJ2)</td> <td>Ceramics (Si₃N₄)</td> </tr> <tr> <td>X</td> <td>Heat resistant steel (SHX)</td> <td>Ceramics (Si₃N₄)</td> </tr> <tr> <td>XE (Spinshot™ II)</td> <td>Heat resistant steel (SHX)</td> <td>Ceramics (Si₃N₄)</td> </tr> </tbody> </table>	Type	Material		Rings	Rolling elements	S	Bearing steel (SUJ2)	Bearing steel (SUJ2)	H	Bearing steel (SUJ2)	Ceramics (Si ₃ N ₄)	X	Heat resistant steel (SHX)	Ceramics (Si ₃ N ₄)	XE (Spinshot™ II)	Heat resistant steel (SHX)	Ceramics (Si ₃ N ₄)	14-17 24-25
		Type		Material																
			Rings	Rolling elements																
		S	Bearing steel (SUJ2)	Bearing steel (SUJ2)																
		H	Bearing steel (SUJ2)	Ceramics (Si ₃ N ₄)																
X	Heat resistant steel (SHX)	Ceramics (Si ₃ N ₄)																		
XE (Spinshot™ II)	Heat resistant steel (SHX)	Ceramics (Si ₃ N ₄)																		
TYN	Cage	TYN: ball guided polyamide resin cage; limiting speed $d_m n = 1\,400\,000$; operational temperature limit = 120°C T: phenolic resin cage with outer ring guide; operational temperature limit = 120°C	18-19																	
	Seal	No symbol: open type V1V: non-contact rubber seal (‡)	32																	
DBB	Arrangement	SU: universal arrangement (single row) DU: universal arrangement (double row) DB: Back-to-back arrangement DF: Face-to-face arrangement DT: tandem arrangement DBD, DFD, DTD, DUD: triplex set arrangement DBB, DFF, DBT, DFT, DTT, QU: quadruplex set arrangement	42-43 148-151																	
EL	Preload	EL: extra light preload, L: light preload, M: medium preload, H: heavy preload CP: special preload, CA: special axial clearance	42-43 152-155 161-164																	
P4	Accuracy	P2: ISO Class 2, P4: ISO Class 4, P5: ISO Class 5	151																	
		P3: special class (dimensional accuracy: ISO Class 4; rotating accuracy: ISO Class 2)	176-179																	
		P4Y: special class (Bore diameter and outside diameter are exclusive to NSK. All others are ISO Class 4.)																		

(*) Series 20 and 29 are exclusively for sealed angular contact ball bearings.

(‡) Sealed angular contact ball bearings are standardized for SU arrangement and ISO Class 3 standards.

Sealed angular contact ball bearings correspondence numbers BNR19, BNR29, BER19, BER29, BNR10, BNR20, BER10 and BER20: Bore diameter=φ30-100 mm

1. ANGULAR CONTACT BALL BEARINGS

Ultra High-Speed Angular Contact Ball Bearings (ROBUST Series)

BNR19 Series BER19 Series

Bore Diameter 25-80 mm

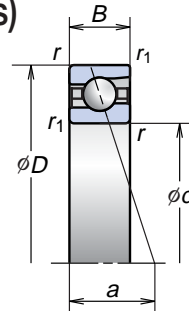

- For additional information: Page No.
- Dynamic equivalent load139
 - Static equivalent load146
 - Preload and rigidity152
 - Abutment and fillet dimensions186
 - Nozzle position192
 - Quantity of packed grease175

BNR19 Series (continued) BER19 Series

Bearing Numbers	Boundary Dimensions (mm)					Basic Load Ratings (kN)		Permissible Axial Load (1) (kN)	Effective Load Center (mm) a	Mass (kg) (approx.)	Sealed Design	Limiting Speeds (2) (min ⁻¹)	
	d	D	B	r (min.)	r ₁ (min.)	C _r (Dynamic)	C _{0r} (Static)					Grease	Oil
25BNR19S	25	42	9	0.3	0.15	5.95	3.50	4.95	9.9	0.042	—	41 800	59 800
25BNR19H	25	42	9	0.3	0.15			3.25		0.038	—	53 800	83 600
25BNR19X	25	42	9	0.3	0.15			—		0.038	—	62 700	98 600
25BER19S	25	42	9	0.3	0.15	5.70	3.40	5.90	12.3	0.042	—	35 900	50 800
25BER19H	25	42	9	0.3	0.15			3.95		0.038	—	47 800	74 700
25BER19X	25	42	9	0.3	0.15			—		0.038	—	56 800	89 600
30BNR19S	30	47	9	0.3	0.15	6.30	4.05	5.75	10.8	0.048	○	36 400	52 000
30BNR19H	30	47	9	0.3	0.15			3.80		0.043	○	46 800	72 800
30BNR19X	30	47	9	0.3	0.15			—		0.043	○	54 600	85 800
30BER19S	30	47	9	0.3	0.15	6.00	3.90	6.80	13.5	0.048	○	31 200	44 200
30BER19H	30	47	9	0.3	0.15			4.60		0.043	○	41 600	65 000
30BER19X	30	47	9	0.3	0.15			—		0.043	○	49 400	78 000
35BNR19S	35	55	10	0.6	0.3	9.20	6.00	8.55	12.3	0.072	○	31 200	44 500
35BNR19H	35	55	10	0.6	0.3			5.60		0.063	○	40 000	62 300
35BNR19X	35	55	10	0.6	0.3			—		0.063	○	46 700	73 400
35BER19S	35	55	10	0.6	0.3	8.80	5.75	10.0	15.5	0.072	○	26 700	37 800
35BER19H	35	55	10	0.6	0.3			6.80		0.063	○	35 600	55 600
35BER19X	35	55	10	0.6	0.3			—		0.063	○	42 300	66 700
40BNR19S	40	62	12	0.6	0.3	11.5	7.65	10.8	14.3	0.105	○	27 500	39 300
40BNR19H	40	62	12	0.6	0.3			7.10		0.092	○	35 300	55 000
40BNR19X	40	62	12	0.6	0.3			—		0.092	○	41 200	64 800
40BER19S	40	62	12	0.6	0.3	11.0	7.35	12.8	17.9	0.105	○	23 600	33 400
40BER19H	40	62	12	0.6	0.3			8.65		0.092	○	31 400	49 100
40BER19X	40	62	12	0.6	0.3			—		0.092	○	37 300	58 900
45BNR19S	45	68	12	0.6	0.3	12.1	8.70	12.4	15.2	0.125	○	24 800	35 400
45BNR19H	45	68	12	0.6	0.3			8.10		0.111	○	31 900	49 600
45BNR19X	45	68	12	0.6	0.3			—		0.111	○	37 200	58 500
45BER19S	45	68	12	0.6	0.3	11.6	8.35	14.6	19.2	0.125	○	21 300	30 100
45BER19H	45	68	12	0.6	0.3			9.85		0.111	○	28 400	44 300
45BER19X	45	68	12	0.6	0.3			—		0.111	○	33 700	53 100
50BNR19S	50	72	12	0.6	0.3	12.8	9.75	13.9	15.9	0.127	○	23 000	32 800
50BNR19H	50	72	12	0.6	0.3			9.10		0.111	○	29 600	46 000
50BNR19X	50	72	12	0.6	0.3			—		0.111	○	34 500	54 100
50BER19S	50	72	12	0.6	0.3	12.3	9.35	16.3	20.2	0.127	○	19 700	27 900
50BER19H	50	72	12	0.6	0.3			11.0		0.111	○	26 300	41 000
50BER19X	50	72	12	0.6	0.3			—		0.111	○	31 200	49 200

(1) For permissible axial load, please refer to Page 147.

(2) For application of limiting speeds, please refer to Page 170.

Note: Bearing type BNR: nominal contact angle 18°

Bearing type BER: nominal contact angle 25°

Bearing Numbers	Boundary Dimensions (mm)					Basic Load Ratings (kN)		Permissible Axial Load (1) (kN)	Effective Load Center (mm) a	Mass (kg) (approx.)	Sealed Design	Limiting Speeds (2) (min ⁻¹)	
	d	D	B	r (min.)	r ₁ (min.)	C _r (Dynamic)	C _{0r} (Static)					Grease	Oil
55BNR19S	55	80	13	1.0	0.6	14.4	11.4	16.2	17.5	0.178	○	20 800	29 700
55BNR19H	55	80	13	1.0	0.6			10.6		0.158	○	26 700	41 500
55BNR19X	55	80	13	1.0	0.6			—		0.158	○	31 200	48 900
55BER19S	55	80	13	1.0	0.6			16.1		0.178	○	17 800	25 200
55BER19H	55	80	13	1.0	0.6	13.8	10.9	12.9	22.2	0.158	○	23 800	37 100
55BER19X	55	80	13	1.0	0.6			—		0.158	○	28 200	44 500
60BNR19S	60	85	13	1.0	0.6	14.6	12.0	17.1	18.3	0.190	○	19 400	27 600
60BNR19H	60	85	13	1.0	0.6			11.2		0.170	○	24 900	38 700
60BNR19X	60	85	13	1.0	0.6			—		0.170	○	29 000	45 600
60BER19S	60	85	13	1.0	0.6	14.0	11.5	20.1	23.4	0.190	○	16 600	23 500
60BER19H	60	85	13	1.0	0.6			13.6		0.170	○	22 100	34 500
60BER19X	60	85	13	1.0	0.6			—		0.170	○	26 300	41 400
65BNR19S	65	90	13	1.0	0.6	15.2	13.2	18.7	19.1	0.204	○	18 100	25 900
65BNR19H	65	90	13	1.0	0.6			12.3		0.181	○	23 300	36 200
65BNR19X	65	90	13	1.0	0.6			—		0.181	○	27 100	42 600
65BER19S	65	90	13	1.0	0.6	14.5	12.6	22.1	24.6	0.204	○	15 500	22 000
65BER19H	65	90	13	1.0	0.6			14.9		0.181	○	20 700	32 300
65BER19X	65	90	13	1.0	0.6			—		0.181	○	24 600	38 800
70BNR19S	70	100	16	1.0	0.6	21.3	18.1	26.1	21.8	0.328	○	16 500	23 600
70BNR19H	70	100	16	1.0	0.6			17.1		0.292	○	21 200	33 000
70BNR19X	70	100	16	1.0	0.6			—		0.292	○	24 800	38 900
70BER19S	70	100	16	1.0	0.6	20.4	17.3	30.5	27.8	0.328	○	14 200	20 000
70BER19H	70	100	16	1.0	0.6			20.7		0.292	○	18 900	29 500
70BER19X	70	100	16	1.0	0.6			—		0.292	○	22 400	35 300
75BNR19S	75	105	16	1.0	0.6	21.6	19.0	27.5	22.6	0.348	○	15 600	22 300
75BNR19H	75	105	16	1.0	0.6			18.0		0.310	○	20 000	31 200
75BNR19X	75	105	16	1.0	0.6			—		0.310	○	23 400	36 700
75BER19S	75	105	16	1.0	0.6	20.7	18.2	32.5	29.0	0.348	○	13 400	18 900
75BER19H	75	105	16	1.0	0.6			21.7		0.310	○	17 800	27 800
75BER19X	75	105	16	1.0	0.6			—		0.310	○	21 200	33 400
80BNR19S	80	110	16	1.0	0.6	22.0	19.9	28.9	23.4	0.366	○	14 800	21 100
80BNR19H	80	110	16	1.0	0.6			18.9		0.326	○	19 000	29 500
80BNR19X	80	110	16	1.0	0.6			—		0.326	○	22 200	34 800
80BER19S	80	110	16	1.0	0.6	21.0	19.1	34.0	30.1	0.366	○	12 700	17 900
80BER19H	80	110	16	1.0	0.6			22.8		0.326	○	16 900	26 400
80BER19X	80	110	16	1.0	0.6			—		0.326	○	20 000	31 600

(1) For permissible axial load, please refer to Page 147.

(2) For application of limiting speeds, please refer to Page 170.

Note: Bearing type BNR: nominal contact angle 18°

Bearing type BER: nominal contact angle 25°

1. ANGULAR CONTACT BALL BEARINGS

Ultra High-Speed Angular Contact Ball Bearings (ROBUST Series)

BNR19 Series BER19 Series

Bore Diameter 85-150 mm

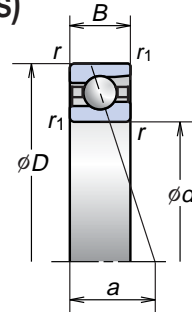

- For additional information: Page No.
- Dynamic equivalent load139
 - Static equivalent load146
 - Preload and rigidity152
 - Abutment and fillet dimensions186
 - Nozzle position192
 - Quantity of packed grease175

Bearing Numbers	Boundary Dimensions (mm)					Basic Load Ratings (kN)		Permissible Axial Load ⁽¹⁾ (kN)	Effective Load Center (mm) a	Mass (kg) (approx.)	Sealed Design	Limiting Speeds ⁽²⁾ (min ⁻¹)	
	d	D	B	r (min.)	r ₁ (min.)	C _r (Dynamic)	C _{0r} (Static)					Grease	Oil
85BNR19S	85	120	18	1.1	0.6	29.4	26.3	38.0	25.7	0.527	○	13 700	19 600
85BNR19H	85	120	18	1.1	0.6			24.8				17 600	27 400
85BNR19X	85	120	18	1.1	0.6			24.8				20 500	32 200
85BER19S	85	120	18	1.1	0.6	28.1	25.2	35.5	32.9	0.527	○	11 800	16 600
85BER19H	85	120	18	1.1	0.6			30.0				15 700	24 400
85BER19X	85	120	18	1.1	0.6			30.0				18 600	29 300
90BNR19S	90	125	18	1.1	0.6	31.5	29.7	43.0	26.5	0.552	○	13 100	18 700
90BNR19H	90	125	18	1.1	0.6			28.1				16 800	26 100
90BNR19X	90	125	18	1.1	0.6			28.1				19 600	30 700
90BER19S	90	125	18	1.1	0.6	30.0	28.5	50.5	34.1	0.552	○	11 200	15 900
90BER19H	90	125	18	1.1	0.6			34.0				14 900	23 300
90BER19X	90	125	18	1.1	0.6			34.0				17 700	28 000
95BNR19S	95	130	18	1.1	0.6	32.0	31.0	50.0	28.3	0.571	○	12 500	17 800
95BNR19H	95	130	18	1.1	0.6			32.5				16 000	24 900
95BNR19X	95	130	18	1.1	0.6			32.5				18 700	29 400
95BER19S	95	130	18	1.1	0.6	30.5	29.7	58.5	36.7	0.571	○	10 700	15 200
95BER19H	95	130	18	1.1	0.6			39.5				14 300	22 300
95BER19X	95	130	18	1.1	0.6			39.5				16 900	26 700
100BNR19S	100	140	20	1.1	0.6	38.0	35.0	50.5	29.5	0.770	○	11 700	16 700
100BNR19H	100	140	20	1.1	0.6			33.0				15 000	23 400
100BNR19X	100	140	20	1.1	0.6			33.0				17 500	27 500
100BER19S	100	140	20	1.1	0.6	36.0	33.5	59.5	38.0	0.770	○	10 000	14 200
100BER19H	100	140	20	1.1	0.6			40.0				13 400	20 900
100BER19X	100	140	20	1.1	0.6			40.0				15 900	25 000
105BNR19S	105	145	20	1.1	0.6	38.5	36.5	53.0	31.5	0.795	-	11 200	16 000
105BNR19H	105	145	20	1.1	0.6			39.0				14 400	22 400
105BNR19X	105	145	20	1.1	0.6			39.0				16 800	26 400
105BER19S	105	145	20	1.1	0.6	37.0	35.0	62.0	40.9	0.795	-	9 600	13 600
105BER19H	105	145	20	1.1	0.6			42.0				12 800	20 000
105BER19X	105	145	20	1.1	0.6			42.0				15 200	24 000

⁽¹⁾ For permissible axial load, please refer to Page 147.
⁽²⁾ For application of limiting speeds, please refer to Page 170.
Note: Bearing type BNR: nominal contact angle 18°
 Bearing type BER: nominal contact angle 25°

BNR19 Series BER19 Series (continued)

Bearing Numbers	Boundary Dimensions (mm)					Basic Load Ratings (kN)		Permissible Axial Load ⁽¹⁾ (kN)	Effective Load Center (mm) a	Mass (kg) (approx.)	Sealed Design	Limiting Speeds ⁽²⁾ (min ⁻¹)	
	d	D	B	r (min.)	r ₁ (min.)	C _r (Dynamic)	C _{0r} (Static)					Grease	Oil
110BNR19S	110	150	20	1.1	0.6	39.0	38.0	55.5	31.1	0.838	-	10 800	15 400
110BNR19H	110	150	20	1.1	0.6			42.0				13 900	21 600
110BNR19X	110	150	20	1.1	0.6			42.0				16 200	25 400
110BER19S	110	150	20	1.1	0.6	37.5	36.5	65.0	40.3	0.733	-	9 300	13 100
110BER19H	110	150	20	1.1	0.6			44.0				12 400	19 300
110BER19X	110	150	20	1.1	0.6			44.0				14 700	23 100
120BNR19S	120	165	22	1.1	0.6	54.0	52.0	75.0	34.2	1.124	-	9 900	14 100
120BNR19H	120	165	22	1.1	0.6			49.0				12 700	19 700
120BNR19X	120	165	22	1.1	0.6			49.0				14 800	23 200
120BER19S	120	165	22	1.1	0.6	51.5	50.0	88.0	44.2	0.949	-	8 500	12 000
120BER19H	120	165	22	1.1	0.6			59.5				11 300	17 600
120BER19X	120	165	22	1.1	0.6			59.5				13 400	21 100
130BNR19S	130	180	24	1.5	1.0	59.5	58.5	85.0	37.2	1.477	-	9 100	13 000
130BNR19H	130	180	24	1.5	1.0			56.0				11 700	18 100
130BER19S	130	180	24	1.5	1.0			100				7 800	11 000
130BER19H	130	180	24	1.5	1.0	57.0	56.5	67.5	48.1	1.265	-	10 400	16 200
140BNR19S	140	190	24	1.5	1.0			89.5				8 500	12 200
140BNR19H	140	190	24	1.5	1.0	60.0	61.5	58.5	38.8	1.567	-	11 000	17 000
140BER19S	140	190	24	1.5	1.0			105				7 300	10 400
140BER19H	140	190	24	1.5	1.0	57.5	59.0	70.5	50.5	1.353	-	9 700	15 200
150BNR19S	150	210	28	2.0	1.0			114				7 800	11 200
150BNR19H	150	210	28	2.0	1.0	77.0	78.5	75.0	43.2	2.459	-	10 000	15 600
150BER19S	150	210	28	2.0	1.0			134				6 700	9 500
150BER19H	150	210	28	2.0	1.0	73.5	75.5	90.5	55.9	2.139	-	8 900	13 900

⁽¹⁾ For permissible axial load, please refer to Page 147.
⁽²⁾ For application of limiting speeds, please refer to Page 170.
Note: Bearing type BNR: nominal contact angle 18°
 Bearing type BER: nominal contact angle 25°

1. ANGULAR CONTACT BALL BEARINGS

Ultra High-Speed Angular Contact Ball Bearings (ROBUST Series)

BNR10 Series BER10 Series

Bore Diameter 30-80 mm

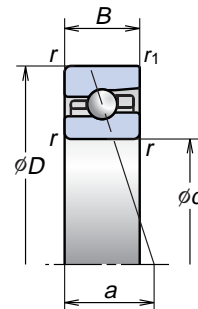

- For additional information: Page No.
- Dynamic equivalent load139
 - Static equivalent load146
 - Preload and rigidity152
 - Abutment and fillet dimensions186
 - Nozzle position192
 - Quantity of packed grease175

Bearing Numbers	Boundary Dimensions (mm)					Basic Load Ratings (kN)		Permissible Axial Load ⁽¹⁾ (kN)	Effective Load Center (mm) a	Mass (kg) (approx.)	Sealed Design	Limiting Speeds ⁽²⁾ (min ⁻¹)	
	d	D	B	r (min.)	r ₁ (min.)	C _r (Dynamic)	C _{0r} (Static)					Grease	Oil
30BNR10S	30	55	13	1.0	0.6	8.65	5.75	8.20	13.3	0.124	○	33 000	47 100
30BNR10H	30	55	13	1.0	0.6			5.35				42 400	65 900
30BNR10X	30	55	13	1.0	0.6			5.35				49 500	77 700
30BER10S	30	55	13	1.0	0.6	8.30	5.50	9.65	16.3	0.124	○	28 300	40 000
30BER10H	30	55	13	1.0	0.6			6.50				37 700	58 900
30BER10X	30	55	13	1.0	0.6			6.50				44 800	70 600
35BNR10S	35	62	14	1.0	0.6	10.1	7.10	10.2	14.8	0.164	○	28 900	41 300
35BNR10H	35	62	14	1.0	0.6			6.70				37 200	57 800
35BNR10X	35	62	14	1.0	0.6			6.70				43 300	68 100
35BER10S	35	62	14	1.0	0.6	9.70	6.85	12.0	18.2	0.164	○	24 800	35 100
35BER10H	35	62	14	1.0	0.6			8.10				33 000	51 600
35BER10X	35	62	14	1.0	0.6			8.10				39 200	61 900
40BNR10S	40	68	15	1.0	0.6	10.6	7.95	11.5	16.2	0.204	○	26 000	37 100
40BNR10H	40	68	15	1.0	0.6			7.50				33 400	51 900
40BNR10X	40	68	15	1.0	0.6			7.50				38 900	61 200
40BER10S	40	68	15	1.0	0.6	10.1	7.65	13.5	19.9	0.204	○	22 300	31 500
40BER10H	40	68	15	1.0	0.6			9.10				29 700	46 300
40BER10X	40	68	15	1.0	0.6			9.10				35 200	55 600
45BNR10S	45	75	16	1.0	0.6	11.7	9.00	12.7	17.6	0.259	○	23 400	33 400
45BNR10H	45	75	16	1.0	0.6			8.35				30 000	46 700
45BNR10X	45	75	16	1.0	0.6			8.35				35 000	55 000
45BER10S	45	75	16	1.0	0.6	11.2	8.60	15.0	21.8	0.259	○	20 000	28 400
45BER10H	45	75	16	1.0	0.6			10.1				26 700	41 700
45BER10X	45	75	16	1.0	0.6			10.1				31 700	50 000
50BNR10S	50	80	16	1.0	0.6	12.2	9.90	14.0	18.4	0.281	○	21 600	30 800
50BNR10H	50	80	16	1.0	0.6			9.20				27 700	43 100
50BNR10X	50	80	16	1.0	0.6			9.20				32 400	50 800
50BER10S	50	80	16	1.0	0.6	11.6	9.50	16.5	23.0	0.281	○	18 500	26 200
50BER10H	50	80	16	1.0	0.6			11.1				24 700	38 500
50BER10X	50	80	16	1.0	0.6			11.1				29 300	46 200

⁽¹⁾ For permissible axial load, please refer to Page 147.
⁽²⁾ For application of limiting speeds, please refer to Page 170.
Note: Bearing type BNR: nominal contact angle 18°
 Bearing type BER: nominal contact angle 25°

BNR10 Series (continued) BER10 Series

Bearing Numbers	Boundary Dimensions (mm)					Basic Load Ratings (kN)		Permissible Axial Load ⁽¹⁾ (kN)	Effective Load Center (mm) a	Mass (kg) (approx.)	Sealed Design	Limiting Speeds ⁽²⁾ (min ⁻¹)	
	d	D	B	r (min.)	r ₁ (min.)	C _r (Dynamic)	C _{0r} (Static)					Grease	Oil
55BNR10S	55	90	18	1.1	0.6	15.1	12.5	17.8	20.6	0.414	○	19400	27600
55BNR10H	55	90	18	1.1	0.6			11.7				24 900	38 700
55BNR10X	55	90	18	1.1	0.6			11.7				29 000	45 600
55BER10S	55	90	18	1.1	0.6			14.4				12.0	21.0
55BER10H	55	90	18	1.1	0.6	14.1	22 100		34 500				
55BER10X	55	90	18	1.1	0.6	14.1	26 300		41 400				
60BNR10S	60	95	18	1.1	0.6	15.6	13.7		19.5	21.5	0.443		○
60BNR10H	60	95	18	1.1	0.6			12.8	23 300			36 200	
60BNR10X	60	95	18	1.1	0.6			12.8	27 100			42 600	
60BER10S	60	95	18	1.1	0.6	15.0	13.1	22.9	26.9	0.443	○	15 500	22 000
60BER10H	60	95	18	1.1	0.6			15.5				20 700	32 300
60BER10X	60	95	18	1.1	0.6			15.5				24 600	38 800
65BNR10S	65	100	18	1.1	0.6			16.2				14.8	21.1
65BNR10H	65	100	18	1.1	0.6	13.9	21 900		34 000				
65BNR10X	65	100	18	1.1	0.6	13.9	25 500		40 000				
65BER10S	65	100	18	1.1	0.6	15.5	14.2	24.9	28.0	0.472	○	14 600	20 700
65BER10H	65	100	18	1.1	0.6			16.8				19 400	30 400
65BER10X	65	100	18	1.1	0.6			16.8				23 100	36 400
70BNR10S	70	110	20	1.1	0.6			22.3				19.8	28.6
70BNR10H	70	110	20	1.1	0.6	18.8	20 000		31 200				
70BNR10X	70	110	20	1.1	0.6	18.8	23 400		36 700				
70BER10S	70	110	20	1.1	0.6	21.3	18.9	33.5	30.8	0.645	○	13 400	18 900
70BER10H	70	110	20	1.1	0.6			22.6				17 800	27 800
70BER10X	70	110	20	1.1	0.6			22.6				21 200	33 400
75BNR10S	75	115	20	1.1	0.6			22.6				20.7	30.0
75BNR10H	75	115	20	1.1	0.6	19.7	19 000		29 500				
75BNR10X	75	115	20	1.1	0.6	19.7	22 200		34 800				
75BER10S	75	115	20	1.1	0.6	21.6	19.8	35.0	31.9	0.679	○	12 700	17 900
75BER10H	75	115	20	1.1	0.6			23.7				16 900	26 400
75BER10X	75	115	20	1.1	0.6			23.7				20 000	31 600
80BNR10S	80	125	22	1.1	0.6			26.5				24.5	35.5
80BNR10H	80	125	22	1.1	0.6	23.4	17 600		27 400				
80BNR10X	80	125	22	1.1	0.6	23.4	20 500		32 200				
80BER10S	80	125	22	1.1	0.6	25.3	23.5		42.0	34.6	0.921		○
80BER10H	80	125	22	1.1	0.6			28.2	15 700			24 400	
80BER10X	80	125	22	1.1	0.6			28.2	18 600			29 300	

⁽¹⁾ For permissible axial load, please refer to Page 147.
⁽²⁾ For application of limiting speeds, please refer to Page 170.
Note: Bearing type BNR: nominal contact angle 18°
 Bearing type BER: nominal contact angle 25°

1. ANGULAR CONTACT BALL BEARINGS

Ultra High-Speed Angular Contact Ball Bearings (ROBUST Series)

BNR10 Series BER10 Series

Bore Diameter 85-150 mm

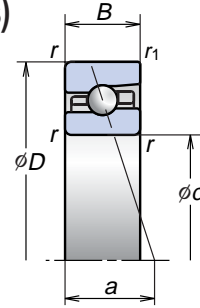

- For additional information: Page No.
- Dynamic equivalent load139
 - Static equivalent load146
 - Preload and rigidity152
 - Abutment and fillet dimensions186
 - Nozzle position192
 - Quantity of packed grease175

Bearing Numbers	Boundary Dimensions (mm)					Basic Load Ratings (kN)		Permissible Axial Load (1) (kN)	Effective Load Center (mm) a	Mass (kg) (approx.)	Sealed Design	Limiting Speeds (2) (min ⁻¹)	
	d	D	B	r (min.)	r ₁ (min.)	C _r (Dynamic)	C _{0r} (Static)					Grease	Oil
85BNR10S	85	130	22	1.1	0.6	26.8	25.7	37.5	28.4	0.962	○	13 100	18 700
85BNR10H	85	130	22	1.1	0.6			24.5		0.906	○	16 800	26 100
85BNR10X	85	130	22	1.1	0.6					0.906	○	19 600	30 700
85BER10S	85	130	22	1.1	0.6	25.6	24.6	43.5	36.1	0.962	○	11 200	15 900
85BER10H	85	130	22	1.1	0.6			29.5		0.906	○	14 900	23 300
85BER10X	85	130	22	1.1	0.6					0.906	○	17 700	28 000
90BNR10S	90	140	24	1.5	1.0	35.0	33.0	48.0	30.7	1.241	○	12 200	17 400
90BNR10H	90	140	24	1.5	1.0			31.5		1.155	○	15 700	24 400
90BNR10X	90	140	24	1.5	1.0					1.155	○	18 300	28 700
90BER10S	90	140	24	1.5	1.0	33.5	31.5	56.0	38.8	1.241	○	10 500	14 800
90BER10H	90	140	24	1.5	1.0			38.0		1.155	○	14 000	21 800
90BER10X	90	140	24	1.5	1.0					1.155	○	16 600	26 100
95BNR10S	95	145	24	1.5	1.0	35.5	34.5	50.0	31.3	1.298	○	11 700	16 700
95BNR10H	95	145	24	1.5	1.0			32.5		1.209	○	15 000	23 400
95BNR10X	95	145	24	1.5	1.0					1.209	○	17 500	27 500
95BER10S	95	145	24	1.5	1.0	34.0	33.0	58.5	39.7	1.298	○	10 000	14 200
95BER10H	95	145	24	1.5	1.0			39.5		1.209	○	13 400	20 900
95BER10X	95	145	24	1.5	1.0					1.209	○	15 900	25 000
100BNR10S	100	150	24	1.5	1.0	36.0	36.0	52.0	32.3	1.245	○	11 200	16 000
100BNR10H	100	150	24	1.5	1.0			34.0		1.253	○	14 400	22 400
100BNR10X	100	150	24	1.5	1.0					1.253	○	16 800	26 400
100BER10S	100	150	24	1.5	1.0	34.5	34.5	61.0	41.2	1.245	○	9 600	13 600
100BER10H	100	150	24	1.5	1.0			41.0		1.253	○	12 800	20 000
100BER10X	100	150	24	1.5	1.0					1.253	○	15 200	24 000
105BNR10S	105	160	26	2.0	1.0	41.0	41.0	59.5	34.5	1.698	—	10 600	15 100
105BNR10H	105	160	26	2.0	1.0			39.0		1.585	—	13 600	21 200
105BNR10X	105	160	26	2.0	1.0					1.585	—	15 900	25 000
105BER10S	105	160	26	2.0	1.0	39.0	39.5	70.0	43.9	1.698	—	9 100	12 900
105BER10H	105	160	26	2.0	1.0			47.5		1.585	—	12 100	18 900
105BER10X	105	160	26	2.0	1.0					1.585	—	14 400	22 700

(1) For permissible axial load, please refer to Page 147.
 (2) For application of limiting speeds, please refer to Page 170.
 Note: Bearing type BNR: nominal contact angle 18°
 Bearing type BER: nominal contact angle 25°

BNR10 Series (continued) BER10 Series

Bearing Numbers	Boundary Dimensions (mm)					Basic Load Ratings (kN)		Permissible Axial Load (1) (kN)	Effective Load Center (mm) a	Mass (kg) (approx.)	Sealed Design	Limiting Speeds (2) (min ⁻¹)	
	d	D	B	r (min.)	r ₁ (min.)	C _r (Dynamic)	C _{0r} (Static)					Grease	Oil
110BNR10S	110	170	28	2.0	1.0	46.0	47.0	68.0	36.7	2.133	—	10 000	14 300
110BNR10H	110	170	28	2.0	1.0			44.5		1.996	—	12 900	20 000
110BNR10X	110	170	28	2.0	1.0					1.996	—	15 000	23 600
110BER10S	110	170	28	2.0	1.0	44.0	45.0	79.5	46.7	2.133	—	8 600	12 200
110BER10H	110	170	28	2.0	1.0			54.0		1.996	—	11 500	17 900
110BER10X	110	170	28	2.0	1.0					1.996	—	13 600	21 500
120BNR10S	120	180	28	2.0	1.0	47.5	50.5	73.5	38.4	2.286	—	9 400	13 400
120BNR10H	120	180	28	2.0	1.0			48.0		2.139	—	12 000	18 700
120BNR10X	120	180	28	2.0	1.0					2.139	—	14 000	22 000
120BER10S	120	180	28	2.0	1.0	45.5	48.5	86.0	49.0	2.286	—	8 000	11 400
120BER10H	120	180	28	2.0	1.0			58.0		2.139	—	10 700	16 700
120BER10X	120	180	28	2.0	1.0					2.139	—	12 700	20 000
130BNR10S	130	200	33	2.0	1.0	60.0	61.5	89.5	43.0	3.408	—	8 500	12 200
130BNR10H	130	200	33	2.0	1.0			58.5		3.194	—	11 000	17 000
130BER10S	130	200	33	2.0	1.0			105		3.408	—	7 300	10 400
130BER10H	130	200	33	2.0	1.0	57.5	59.0	70.5	54.6	3.194	—	9 700	15 200
140BNR10S	140	210	33	2.0	1.0	62.5	66.5	97.0	44.6	3.647	—	8 000	11 500
140BNR10H	140	210	33	2.0	1.0			63.5		3.419	—	10 300	16 000
140BER10S	140	210	33	2.0	1.0			113		3.647	—	6 900	9 800
140BER10H	140	210	33	2.0	1.0	59.5	64.0	76.5	56.9	3.419	—	9 200	14 300
150BNR10S	150	225	35	2.1	1.0	73.5	78.0	114	47.6	4.405	—	7 500	10 700
150BNR10H	150	225	35	2.1	1.0			74.5		4.129	—	9 600	15 000
150BER10S	150	225	35	2.1	1.0			99.5		4.405	—	6 400	9 100
150BER10H	150	225	35	2.1	1.0	70.0	75.0	90.0	60.8	4.129	—	8 600	13 400

(1) For permissible axial load, please refer to Page 147.
 (2) For application of limiting speeds, please refer to Page 170.
 Note: Bearing type BNR: nominal contact angle 18°
 Bearing type BER: nominal contact angle 25°

1. ANGULAR CONTACT BALL BEARINGS

Ultra High-Speed Angular Contact Ball Bearings (Spinshot™ II Series)

BNR19XE Series BER19XE Series

Bore Diameter 40-110 mm

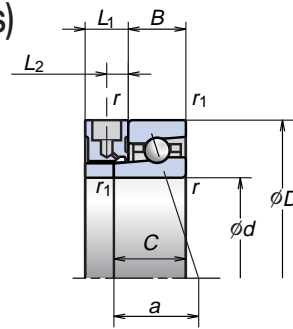

Bearing Numbers	Boundary Dimensions (mm)						Spinshot™ Spacer Dimension (mm)		Basic Load Ratings (kN)		Permissible Axial Load (1) (kN)	Effective Load Center (mm) a	Mass (kg) (approx.)	Limiting Speeds (2) (min ⁻¹)	
	d	D	B	C	r (min.)	r ₁ (min.)	L ₁ (approx.)	L ₂ (approx.)	C _r (Dynamic)	C _{0r} (Static)				Oil	Oil
40BNR19XE	40	62	12	17	0.6	0.3	15	7.5	11.5	7.65	7.10	19.3	0.106	64 800	
40BER19XE	40	62	12	17	0.6	0.3	15	7.5	11.0	7.35	8.65	22.9	0.106	58 900	
45BNR19XE	45	68	12	17	0.6	0.3	15	7.5	12.1	8.70	8.10	20.2	0.128	58 500	
45BER19XE	45	68	12	17	0.6	0.3	15	7.5	11.6	8.35	9.85	24.2	0.128	53 100	
50BNR19XE	50	72	12	17	0.6	0.3	15	7.5	12.8	9.75	9.10	20.9	0.129	54 100	
50BER19XE	50	72	12	17	0.6	0.3	15	7.5	12.3	9.35	11.0	25.2	0.129	49 200	
55BNR19XE	55	80	13	18	1.0	0.6	15	7.5	14.4	11.4	10.6	22.5	0.182	48 900	
55BER19XE	55	80	13	18	1.0	0.6	15	7.5	13.8	10.9	12.9	27.2	0.182	44 500	
60BNR19XE	60	85	13	18	1.0	0.6	15	7.5	14.6	12.0	11.2	23.3	0.196	45 600	
60BER19XE	60	85	13	18	1.0	0.6	15	7.5	14.0	11.5	13.6	28.4	0.196	41 400	
65BNR19XE	65	90	13	18	1.0	0.6	15	7.5	15.2	13.2	12.3	24.1	0.209	42 600	
65BER19XE	65	90	13	18	1.0	0.6	15	7.5	14.5	12.6	14.9	29.6	0.209	38 800	
70BNR19XE	70	100	16	21	1.0	0.6	15	7.5	21.3	18.1	17.1	26.8	0.328	38 900	
70BER19XE	70	100	16	21	1.0	0.6	15	7.5	20.4	17.3	20.7	32.8	0.328	35 300	
75BNR19XE	75	105	16	21	1.0	0.6	15	7.5	21.6	19.0	18.0	27.6	0.348	36 700	
75BER19XE	75	105	16	21	1.0	0.6	15	7.5	20.7	18.2	21.7	34.0	0.348	33 400	
80BNR19XE	80	110	16	21	1.0	0.6	15	7.5	22.0	19.9	18.9	28.4	0.366	34 800	
80BER19XE	80	110	16	21	1.0	0.6	15	7.5	21.0	19.1	22.8	35.1	0.366	31 600	
85BNR19XE	85	120	18	23	1.1	0.6	15	7.5	29.4	26.3	24.8	30.7	0.506	32 200	
85BER19XE	85	120	18	23	1.1	0.6	15	7.5	28.1	25.2	30.0	37.9	0.506	29 300	
90BNR19XE	90	125	18	23	1.1	0.6	15	7.5	31.5	29.7	28.1	31.5	0.532	30 700	
90BER19XE	90	125	18	23	1.1	0.6	15	7.5	30.0	28.5	34.0	39.1	0.532	28 000	
95BNR19XE	95	130	18	23	1.1	0.6	15	7.5	35.5	34.5	32.5	33.3	0.589	29 400	
95BER19XE	95	130	18	23	1.1	0.6	15	7.5	34.0	33.0	39.5	41.7	0.589	26 700	
100BNR19XE	100	140	20	25	1.1	0.6	15	7.5	38.0	35.0	33.0	34.5	0.739	27 500	
100BER19XE	100	140	20	25	1.1	0.6	15	7.5	36.0	33.5	40.0	43.0	0.739	25 000	
105BNR19XE	105	145	20	25	1.1	0.6	15	7.5	41.0	41.0	39.0	36.5	0.758	26 400	
105BER19XE	105	145	20	25	1.1	0.6	15	7.5	39.0	39.5	47.5	45.9	0.758	24 000	
110BNR19XE	110	150	20	25	1.1	0.6	15	7.5	39.0	38.0	36.5	36.1	0.804	25 400	
110BER19XE	110	150	20	25	1.1	0.6	15	7.5	37.5	36.5	44.0	45.3	0.804	23 100	

(1) For permissible axial load, please refer to Page 147.
 (2) For application of limiting speeds, please refer to Page 170.
Note: Bearing type BNR: nominal contact angle 18°
 Bearing type BER: nominal contact angle 25°

BNR10XE Series BER10XE Series

Bore Diameter 40-110 mm

For additional information: Page No.
 ● Dynamic equivalent load139
 ● Static equivalent load146
 ● Preload and rigidity152
 ● Shoulder and fillet dimensions186

Bearing Numbers	Boundary Dimensions (mm)						Spinshot™ Spacer Dimension (mm)		Basic Load Ratings (kN)		Permissible Axial Load (1) (kN)	Effective Load Center (mm) a	Mass (kg) (approx.)	Limiting Speeds (2) (min ⁻¹)	
	d	D	B	C	r (min.)	r ₁ (min.)	L ₁ (approx.)	L ₂ (approx.)	C _r (Dynamic)	C _{0r} (Static)				Oil	Oil
40BNR10XE	40	68	15	20	1.0	0.6	15	7.5	10.6	7.95	7.50	21.2	0.217	61 200	
40BER10XE	40	68	15	20	1.0	0.6	15	7.5	10.1	7.65	9.10	24.9	0.217	55 600	
45BNR10XE	45	75	16	21	1.0	0.6	15	7.5	11.7	9.00	8.35	22.6	0.273	55 000	
45BER10XE	45	75	16	21	1.0	0.6	15	7.5	11.2	8.60	10.1	26.8	0.273	50 000	
50BNR10XE	50	80	16	21	1.0	0.6	15	7.5	12.2	9.90	9.20	23.4	0.296	50 800	
50BER10XE	50	80	16	21	1.0	0.6	15	7.5	11.6	9.50	11.1	28.0	0.296	46 200	
55BNR10XE	55	90	18	23	1.1	0.6	15	7.5	15.1	12.5	11.7	25.6	0.433	45 600	
55BER10XE	55	90	18	23	1.1	0.6	15	7.5	14.4	12.0	14.1	30.7	0.433	41 400	
60BNR10XE	60	95	18	23	1.1	0.6	15	7.5	15.6	13.7	12.8	26.5	0.463	42 600	
60BER10XE	60	95	18	23	1.1	0.6	15	7.5	15.0	13.1	15.5	31.9	0.463	38 800	
65BNR10XE	65	100	18	23	1.1	0.6	15	7.5	16.2	14.8	13.9	27.3	0.493	40 000	
65BER10XE	65	100	18	23	1.1	0.6	15	7.5	15.5	14.2	16.8	33.0	0.493	36 400	
70BNR10XE	70	110	20	25	1.1	0.6	15	7.5	22.3	19.8	18.8	29.5	0.660	36 700	
70BER10XE	70	110	20	25	1.1	0.6	15	7.5	21.3	18.9	22.6	35.8	0.660	33 400	
75BNR10XE	75	115	22	27	1.1	0.6	15	7.5	22.6	20.7	19.7	30.3	0.697	34 800	
75BER10XE	75	115	22	27	1.1	0.6	15	7.5	21.6	19.8	23.7	36.9	0.697	31 600	
80BNR10XE	80	125	22	27	1.1	0.6	15	7.5	26.5	24.5	23.4	32.5	0.939	32 200	
80BER10XE	80	125	22	27	1.1	0.6	15	7.5	25.3	23.5	28.2	39.6	0.939	29 300	
85BNR10XE	85	130	22	27	1.1	0.6	15	7.5	26.8	25.7	24.5	33.4	0.988	30 700	
85BER10XE	85	130	22	27	1.1	0.6	15	7.5	25.6	24.6	29.5	41.1	0.988	28 000	
90BNR10XE	90	140	24	29	1.5	1.0	15	7.5	35.0	33.0	31.5	35.7	1.250	28 700	
90BER10XE	90	140	24	29	1.5	1.0	15	7.5	33.5	31.5	38.0	43.8	1.250	26 100	
95BNR10XE	95	145	24	29	1.5	1.0	15	7.5	35.5	34.5	32.5	36.3	1.300	27 500	
95BER10XE	95	145	24	29	1.5	1.0	15	7.5	34.0	33.0	39.5	44.7	1.300	25 000	
100BNR10XE	100	150	24	29	1.5	1.0	15	7.5	36.0	36.0	34.0	37.3	1.359	26 400	
100BER10XE	100	150	24	29	1.5	1.0	15	7.5	34.5	34.5	41.0	46.2	1.359	24 000	
105BNR10XE	105	160	26	31	2.0	1.0	15	7.5	41.0	41.0	39.0	39.5	1.707	25 000	
105BER10XE	105	160	26	31	2.0	1.0	15	7.5	39.0	39.5	47.5	48.9	1.707	22 700	
110BNR10XE	110	170	28	33	2.0	1.0	15	7.5	46.0	47.0	44.5	41.7	2.139	23 600	
110BER10XE	110	170	28	33	2.0	1.0	15	7.5	44.0	45.0	54.0	51.7	2.139	21 500	

(1) For permissible axial load, please refer to Page 147.
 (2) For application of limiting speeds, please refer to Page 170.
Note: Bearing type BNR: nominal contact angle 18°
 Bearing type BER: nominal contact angle 25°

Angular Contact Ball Bearings

ROBUST

1. ANGULAR CONTACT BALL BEARINGS

Ultra High-Speed Sealed Angular Contact Ball Bearings (Wide Series)

BNR29 Series BER29 Series

Bore Diameter 30-80 mm

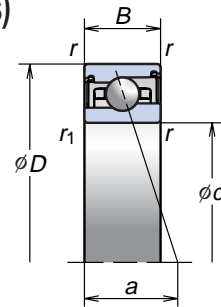

- For additional information: Page No.
- Dynamic equivalent load139
 - Static equivalent load146
 - Preload and rigidity152
 - Abutment and fillet dimensions186
 - Nozzle position192
 - Quantity of packed grease175

Bearing Numbers	Boundary Dimensions (mm)					Basic Load Ratings (kN)		Permissible Axial Load (1) (kN)	Effective Load Center (mm) a	Mass (kg) (approx.)	Limiting Speeds (2)	
	d	D	B	r (min.)	r1 (min.)	Cr (Dynamic)	Cor (Static)				Grease	Oil
30BNR29SV1V	30	47	11	0.3	0.15	6.30	4.05	5.75	11.8	0.057	36 400	
30BNR29HV1V	30	47	11	0.3	0.15			3.80		46 800		
30BNR29XV1V	30	47	11	0.3	0.15			0.053		54 600		
30BER29SV1V	30	47	11	0.3	0.15	6.00	3.90	6.80	14.5	0.057	31 200	
30BER29HV1V	30	47	11	0.3	0.15			4.60		41 600		
30BER29XV1V	30	47	11	0.3	0.15			0.053		49 400		
35BNR29SV1V	35	55	13	0.6	0.3	9.20	6.00	8.55	13.8	0.091	31 200	
35BNR29HV1V	35	55	13	0.6	0.3			5.60		40 000		
35BNR29XV1V	35	55	13	0.6	0.3			0.081		46 700		
35BER29SV1V	35	55	13	0.6	0.3	8.80	5.75	10.0	17.0	0.091	26 700	
35BER29HV1V	35	55	13	0.6	0.3			6.80		35 600		
35BER29XV1V	35	55	13	0.6	0.3			0.081		42 300		
40BNR29SV1V	40	62	14	0.6	0.3	11.5	7.65	10.8	15.3	0.120	27 500	
40BNR29HV1V	40	62	14	0.6	0.3			7.10		35 300		
40BNR29XV1V	40	62	14	0.6	0.3			0.107		41 200		
40BER29SV1V	40	62	14	0.6	0.3	11.0	7.35	12.8	18.9	0.120	23 600	
40BER29HV1V	40	62	14	0.6	0.3			8.65		31 400		
40BER29XV1V	40	62	14	0.6	0.3			0.107		37 300		
45BNR29SV1V	45	68	14	0.6	0.3	12.1	8.70	12.4	16.2	0.143	24 800	
45BNR29HV1V	45	68	14	0.6	0.3			8.10		31 900		
45BNR29XV1V	45	68	14	0.6	0.3			0.128		37 200		
45BER29SV1V	45	68	14	0.6	0.3	11.6	8.35	14.6	20.2	0.143	21 300	
45BER29HV1V	45	68	14	0.6	0.3			9.85		28 400		
45BER29XV1V	45	68	14	0.6	0.3			0.128		33 700		
50BNR29SV1V	50	72	14	0.6	0.3	12.8	9.75	13.9	16.9	0.144	23 000	
50BNR29HV1V	50	72	14	0.6	0.3			9.10		29 600		
50BNR29XV1V	50	72	14	0.6	0.3			0.128		34 500		
50BER29SV1V	50	72	14	0.6	0.3	12.3	9.35	16.3	21.2	0.144	19 700	
50BER29HV1V	50	72	14	0.6	0.3			11.0		26 300		
50BER29XV1V	50	72	14	0.6	0.3			0.128		31 200		

(1) For permissible axial load, please refer to Page 147.
 (2) For application of limiting speeds, please refer to Page 170.
 Note: Bearing type BNR: nominal contact angle 18°
 Bearing type BER: nominal contact angle 25°

BNR29 Series (continued) BER29 Series

Bearing Numbers	Boundary Dimensions (mm)					Basic Load Ratings (kN)		Permissible Axial Load (1) (kN)	Effective Load Center (mm) a	Mass (kg) (approx.)	Limiting Speeds (2)	
	d	D	B	r (min.)	r1 (min.)	Cr (Dynamic)	Cor (Static)				Grease	Oil
55BNR29SV1V	55	80	16	1.0	0.6	14.4	11.4	16.2	19.0	0.213	20 800	
55BNR29HV1V	55	80	16	1.0	0.6			10.6		26 700		
55BNR29XV1V	55	80	16	1.0	0.6			0.194		31 200		
55BER29SV1V	55	80	16	1.0	0.6	13.8	10.9	16.1	23.7	0.213	17 800	
55BER29HV1V	55	80	16	1.0	0.6			12.9		23 800		
55BER29XV1V	55	80	16	1.0	0.6			0.194		28 200		
60BNR29SV1V	60	85	16	1.0	0.6	14.6	12.0	17.1	19.8	0.228	19 400	
60BNR29HV1V	60	85	16	1.0	0.6			11.2		24 900		
60BNR29XV1V	60	85	16	1.0	0.6			0.208		29 000		
60BER29SV1V	60	85	16	1.0	0.6	14.0	11.5	20.1	24.9	0.228	16 600	
60BER29HV1V	60	85	16	1.0	0.6			13.6		22 100		
60BER29XV1V	60	85	16	1.0	0.6			0.208		26 300		
65BNR29SV1V	65	90	16	1.0	0.6	15.2	13.2	18.7	20.6	0.245	18 100	
65BNR29HV1V	65	90	16	1.0	0.6			12.3		23 300		
65BNR29XV1V	65	90	16	1.0	0.6			0.223		27 100		
65BER29SV1V	65	90	16	1.0	0.6	14.5	12.6	22.1	26.1	0.245	15 500	
65BER29HV1V	65	90	16	1.0	0.6			14.9		20 700		
65BER29XV1V	65	90	16	1.0	0.6			0.223		24 600		
70BNR29SV1V	70	100	19	1.0	0.6	21.3	18.1	26.1	23.3	0.381	16 500	
70BNR29HV1V	70	100	19	1.0	0.6			17.1		21 200		
70BNR29XV1V	70	100	19	1.0	0.6			0.344		24 800		
70BER29SV1V	70	100	19	1.0	0.6	20.4	17.3	30.5	29.3	0.381	14 200	
70BER29HV1V	70	100	19	1.0	0.6			20.7		18 900		
70BER29XV1V	70	100	19	1.0	0.6			0.344		22 400		
75BNR29SV1V	75	105	19	1.0	0.6	21.6	19.0	27.5	24.1	0.403	15 600	
75BNR29HV1V	75	105	19	1.0	0.6			18.0		20 000		
75BNR29XV1V	75	105	19	1.0	0.6			0.365		23 400		
75BER29SV1V	75	105	19	1.0	0.6	20.7	18.2	32.5	30.5	0.403	13 400	
75BER29HV1V	75	105	19	1.0	0.6			21.7		17 800		
75BER29XV1V	75	105	19	1.0	0.6			0.365		21 200		
80BNR29SV1V	80	110	19	1.0	0.6	22.0	19.9	28.9	24.9	0.425	14 800	
80BNR29HV1V	80	110	19	1.0	0.6			18.9		19 000		
80BNR29XV1V	80	110	19	1.0	0.6			0.385		22 200		
80BER29SV1V	80	110	19	1.0	0.6	21.0	19.1	34.0	31.6	0.425	12 700	
80BER29HV1V	80	110	19	1.0	0.6			22.8		16 900		
80BER29XV1V	80	110	19	1.0	0.6			0.385		20 000		

(1) For permissible axial load, please refer to Page 147.
 (2) For application of limiting speeds, please refer to Page 170.
 Note: Bearing type BNR: nominal contact angle 18°
 Bearing type BER: nominal contact angle 25°

1. ANGULAR CONTACT BALL BEARINGS

Ultra High-Speed Sealed Angular Contact Ball Bearings (Wide Series)

BNR29 Series BER29 Series

Bore Diameter 85-100 mm

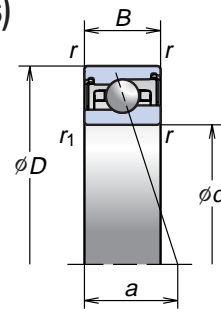

Bearing Numbers	Boundary Dimensions (mm)					Basic Load Ratings (kN)		Permissible Axial Load (1) (kN)	Effective Load Center (mm) a	Mass (kg) (approx.)	Limiting Speeds (2) (min ⁻¹)	
	d	D	B	r (min.)	r ₁ (min.)	C _r (Dynamic)	C _{0r} (Static)				Grease	Oil
85BNR29SV1V	85	120	22	1.1	0.6	29.4	26.3	38.0	27.7	0.617	13 700	
85BNR29HV1V	85	120	22	1.1	0.6			24.8		17 600		
85BNR29XV1V	85	120	22	1.1	0.6			24.8		20 500		
85BER29SV1V	85	120	22	1.1	0.6	28.1	25.2	35.5	34.9	0.617	11 800	
85BER29HV1V	85	120	22	1.1	0.6			30.0		15 700		
85BER29XV1V	85	120	22	1.1	0.6			30.0		18 600		
90BNR29SV1V	90	125	22	1.1	0.6	31.5	29.7	43.0	28.5	0.653	13 100	
90BNR29HV1V	90	125	22	1.1	0.6			28.1		16 800		
90BNR29XV1V	90	125	22	1.1	0.6			28.1		19 600		
90BER29SV1V	90	125	22	1.1	0.6	30.0	28.5	50.5	36.1	0.653	11 200	
90BER29HV1V	90	125	22	1.1	0.6			34.0		14 900		
90BER29XV1V	90	125	22	1.1	0.6			34.0		17 700		
95BNR29SV1V	95	130	22	1.1	0.6	32.0	31.0	50.0	29.3	0.758	12 500	
95BNR29HV1V	95	130	22	1.1	0.6			32.5		16 000		
95BNR29XV1V	95	130	22	1.1	0.6			32.5		18 700		
95BER29SV1V	95	130	22	1.1	0.6	30.5	29.7	58.5	37.2	0.758	10 700	
95BER29HV1V	95	130	22	1.1	0.6			39.5		14 300		
95BER29XV1V	95	130	22	1.1	0.6			39.5		16 900		
100BNR29SV1V	100	140	24	1.1	0.6	38.0	35.0	50.5	31.5	0.770	11 700	
100BNR29HV1V	100	140	24	1.1	0.6			33.0		15 000		
100BNR29XV1V	100	140	24	1.1	0.6			33.0		17 500		
100BER29SV1V	100	140	24	1.1	0.6	36.0	33.5	59.5	40.0	0.902	10 000	
100BER29HV1V	100	140	24	1.1	0.6			40.0		13 400		
100BER29XV1V	100	140	24	1.1	0.6			40.0		15 900		

(1) For permissible axial load, please refer to Page 147.

(2) For application of limiting speeds, please refer to Page 170.

Note: Bearing type BNR: nominal contact angle 18°
Bearing type BER: nominal contact angle 25°

Ultra High-Speed Sealed Angular Contact Ball Bearings (Wide Series)

BNR20 Series BER20 Series

Bore Diameter 30-50 mm

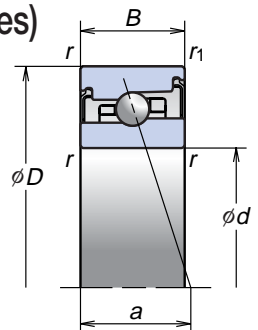

Bearing Numbers	Boundary Dimensions (mm)					Basic Load Ratings (kN)		Permissible Axial Load (1) (kN)	Effective Load Center (mm) a	Mass (kg) (approx.)	Limiting Speeds (2) (min ⁻¹)	
	d	D	B	r (min.)	r ₁ (min.)	C _r (Dynamic)	C _{0r} (Static)				Grease	Oil
30BNR20SV1V	30	55	16	1.0	0.6	8.65	5.75	8.20	14.9	0.150	33 000	
30BNR20HV1V	30	55	16	1.0	0.6			5.35		42 400		
30BNR20XV1V	30	55	16	1.0	0.6			5.35		49 500		
30BER20SV1V	30	55	16	1.0	0.6	8.30	5.50	9.65	17.9	0.150	28 300	
30BER20HV1V	30	55	16	1.0	0.6			6.50		37 700		
30BER20XV1V	30	55	16	1.0	0.6			6.50		44 800		
35BNR20SV1V	35	62	17	1.0	0.6	10.1	7.10	10.2	16.4	0.197	28 900	
35BNR20HV1V	35	62	17	1.0	0.6			6.70		37 200		
35BNR20XV1V	35	62	17	1.0	0.6			6.70		43 300		
35BER20SV1V	35	62	17	1.0	0.6	9.70	6.85	12.0	19.8	0.197	24 800	
35BER20HV1V	35	62	17	1.0	0.6			8.10		33 000		
35BER20XV1V	35	62	17	1.0	0.6			8.10		39 200		
40BNR20SV1V	40	68	18	1.0	0.6	10.6	7.95	11.5	17.8	0.242	26 000	
40BNR20HV1V	40	68	18	1.0	0.6			7.50		33 400		
40BNR20XV1V	40	68	18	1.0	0.6			7.50		38 900		
40BER20SV1V	40	68	18	1.0	0.6	10.1	7.65	13.5	21.6	0.242	22 300	
40BER20HV1V	40	68	18	1.0	0.6			9.10		29 700		
40BER20XV1V	40	68	18	1.0	0.6			9.10		35 200		
45BNR20SV1V	45	75	19	1.0	0.6	11.7	9.00	12.7	19.2	0.305	23 400	
45BNR20HV1V	45	75	19	1.0	0.6			8.35		30 000		
45BNR20XV1V	45	75	19	1.0	0.6			8.35		35 000		
45BER20SV1V	45	75	19	1.0	0.6	11.2	8.60	15.0	23.5	0.305	20 000	
45BER20HV1V	45	75	19	1.0	0.6			10.1		26 700		
45BER20XV1V	45	75	19	1.0	0.6			10.1		31 700		
50BNR20SV1V	50	80	19	1.0	0.6	12.2	9.90	14.0	20.1	0.330	21 600	
50BNR20HV1V	50	80	19	1.0	0.6			9.20		27 700		
50BNR20XV1V	50	80	19	1.0	0.6			9.20		32 400		
50BER20SV1V	50	80	19	1.0	0.6	11.6	9.50	16.5	24.7	0.330	18 500	
50BER20HV1V	50	80	19	1.0	0.6			11.1		24 700		
50BER20XV1V	50	80	19	1.0	0.6			11.1		29 300		

(1) For permissible axial load, please refer to Page 147.

(2) For application of limiting speeds, please refer to Page 170.

Note: Bearing type BNR: nominal contact angle 18°
Bearing type BER: nominal contact angle 25°

1. ANGULAR CONTACT BALL BEARINGS

Ultra High-Speed Sealed Angular Contact Ball Bearings (Wide Series)

BNR20 Series BER20 Series

Bore Diameter 55-100 mm

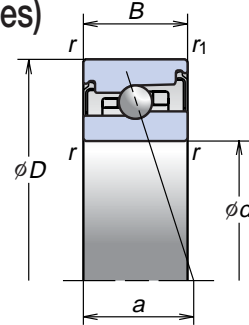

- For additional information: Page No.
- Dynamic equivalent load139
 - Static equivalent load146
 - Preload and rigidity152
 - Abutment and fillet dimensions186
 - Nozzle position192
 - Quantity of packed grease175

BNR20 Series (continued) BER20 Series

Bearing Numbers	Boundary Dimensions (mm)					Basic Load Ratings (kN)		Permissible Axial Load (1) (kN)	Effective Load Center (mm) a	Mass (kg) (approx.)	Limiting Speeds (2)	
	d	D	B	r (min.)	r1 (min.)	Cr (Dynamic)	Cor (Static)				Grease	Oil
55BNR20SV1V	55	90	22	1.1	0.6	15.1	12.5	17.8	22.8	0.501	19 400	
55BNR20HV1V	55	90	22	1.1	0.6			11.7		0.480	24 900	
55BNR20XV1V	55	90	22	1.1	0.6			0.480		29 000		
55BER20SV1V	55	90	22	1.1	0.6	14.4	12.0	21.0	27.9	0.501	16 600	
55BER20HV1V	55	90	22	1.1	0.6			14.1		0.480	22 100	
55BER20XV1V	55	90	22	1.1	0.6			0.480		26 300		
60BNR20SV1V	60	95	22	1.1	0.6	15.6	13.7	19.5	23.6	0.535	18 100	
60BNR20HV1V	60	95	22	1.1	0.6			12.8		0.512	23 300	
60BNR20XV1V	60	95	22	1.1	0.6			0.512		27 100		
60BER20SV1V	60	95	22	1.1	0.6	15.0	13.1	22.9	29.1	0.535	15 500	
60BER20HV1V	60	95	22	1.1	0.6			15.5		0.512	20 700	
60BER20XV1V	60	95	22	1.1	0.6			0.512		24 600		
65BNR20SV1V	65	100	22	1.1	0.6	16.2	14.8	21.1	24.4	0.570	17 000	
65BNR20HV1V	65	100	22	1.1	0.6			13.9		0.545	21 900	
65BNR20XV1V	65	100	22	1.1	0.6			0.545		25 500		
65BER20SV1V	65	100	22	1.1	0.6	15.5	14.2	24.9	30.2	0.570	14 600	
65BER20HV1V	65	100	22	1.1	0.6			16.8		0.545	19 400	
65BER20XV1V	65	100	22	1.1	0.6			0.545		23 100		
70BNR20SV1V	70	110	24	1.1	0.6	22.3	19.8	28.6	26.6	0.764	15 600	
70BNR20HV1V	70	110	24	1.1	0.6			18.8		0.724	20 000	
70BNR20XV1V	70	110	24	1.1	0.6			0.724		23 400		
70BER20SV1V	70	110	24	1.1	0.6	21.3	18.9	33.5	33.0	0.764	13 400	
70BER20HV1V	70	110	24	1.1	0.6			22.6		0.724	17 800	
70BER20XV1V	70	110	24	1.1	0.6			0.724		21 200		
75BNR20SV1V	75	115	24	1.1	0.6	22.6	20.7	30.0	27.4	0.806	14 800	
75BNR20HV1V	75	115	24	1.1	0.6			19.7		0.764	19 000	
75BNR20XV1V	75	115	24	1.1	0.6			0.764		22 200		
75BER20SV1V	75	115	24	1.1	0.6	21.6	19.8	35.0	34.1	0.806	12 700	
75BER20HV1V	75	115	24	1.1	0.6			23.7		0.764	16 900	
75BER20XV1V	75	115	24	1.1	0.6			0.764		20 000		
80BNR20SV1V	80	125	27	1.1	0.6	26.5	24.5	35.5	30.2	1.115	13 700	
80BNR20HV1V	80	125	27	1.1	0.6			23.4		1.061	17 600	
80BNR20XV1V	80	125	27	1.1	0.6			1.061		20 500		
80BER20SV1V	80	125	27	1.1	0.6	25.3	23.5	42.0	37.4	1.115	11 800	
80BER20HV1V	80	125	27	1.1	0.6			28.2		1.061	15 700	
80BER20XV1V	80	125	27	1.1	0.6			1.061		18 600		

(1) For permissible axial load, please refer to Page 147.
 (2) For application of limiting speeds, please refer to Page 170.
Note: Bearing type BNR: nominal contact angle 18°
 Bearing type BER: nominal contact angle 25°

Bearing Numbers	Boundary Dimensions (mm)					Basic Load Ratings (kN)		Permissible Axial Load (1) (kN)	Effective Load Center (mm) a	Mass (kg) (approx.)	Limiting Speeds (2)	
	d	D	B	r (min.)	r1 (min.)	Cr (Dynamic)	Cor (Static)				Grease	Oil
85BNR20SV1V	85	130	27	1.1	0.6	26.8	25.7	37.5	31.0	1.163	13 100	
85BNR20HV1V	85	130	27	1.1	0.6			24.5		1.107	16 800	
85BNR20XV1V	85	130	27	1.1	0.6			1.107		19 600		
85BER20SV1V	85	130	27	1.1	0.6	25.6	24.6	43.5	38.6	1.163	11 200	
85BER20HV1V	85	130	27	1.1	0.6			29.5		1.107	14 900	
85BER20XV1V	85	130	27	1.1	0.6			1.107		17 700		
90BNR20SV1V	90	140	30	1.5	1.0	35.0	33.0	48.0	33.7	1.521	12 200	
90BNR20HV1V	90	140	30	1.5	1.0			31.5		1.436	15 700	
90BNR20XV1V	90	140	30	1.5	1.0			1.436		18 300		
90BER20SV1V	90	140	30	1.5	1.0	33.5	31.5	56.0	41.8	1.521	10 500	
90BER20HV1V	90	140	30	1.5	1.0			38.0		1.436	14 000	
90BER20XV1V	90	140	30	1.5	1.0			1.436		16 600		
95BNR20SV1V	95	145	30	1.5	1.0	35.5	34.5	50.0	34.5	1.595	11 700	
95BNR20HV1V	95	145	30	1.5	1.0			32.5		1.506	15 000	
95BNR20XV1V	95	145	30	1.5	1.0			1.506		17 500		
95BER20SV1V	95	145	30	1.5	1.0	34.0	33.0	58.5	43.0	1.595	10 000	
95BER20HV1V	95	145	30	1.5	1.0			39.5		1.506	13 400	
95BER20XV1V	95	145	30	1.5	1.0			1.506		15 900		
100BNR20SV1V	100	150	30	1.5	1.0	36.0	36.0	52.0	35.3	1.650	11 200	
100BNR20HV1V	100	150	30	1.5	1.0			34.0		1.558	14 400	
100BNR20XV1V	100	150	30	1.5	1.0			1.558		16 800		
100BER20SV1V	100	150	30	1.5	1.0	34.5	34.5	61.0	44.1	1.650	9 600	
100BER20HV1V	100	150	30	1.5	1.0			41.0		1.558	12 800	
100BER20XV1V	100	150	30	1.5	1.0			1.558		15 200		

(1) For permissible axial load, please refer to Page 147.
 (2) For application of limiting speeds, please refer to Page 170.
Note: Bearing type BNR: nominal contact angle 18°
 Bearing type BER: nominal contact angle 25°

1. ANGULAR CONTACT BALL BEARINGS

Ultra High Precision Angular Contact Ball Bearings (ROBUST Series—BGR)

Features

Optimum Design

An outer ring guided cage is used to improve lubrication performance. The counter-bore inner ring improves oil-mist flow to ensure a stable oil supply.

Long Life

Special heat resistant SHX steel and ceramic balls significantly improve service life (X-type bearings).

Easy Mounting

Non-separable inner ring design greatly simplifies mounting and dismounting procedures. Interchangeable assembly for any desired arrangement to meet customer needs.

High Accuracy

BGR Series are standardized for ISO Class 2 (ABMA ABEC 9).

Dimension Series

Fig. 1.5

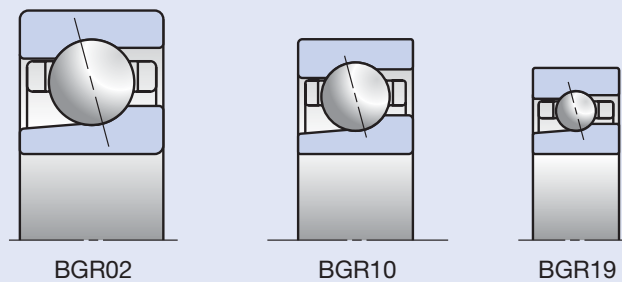

Numbering System of Ultra High Precision Angular Contact Ball Bearings (ROBUST Series—BGR)

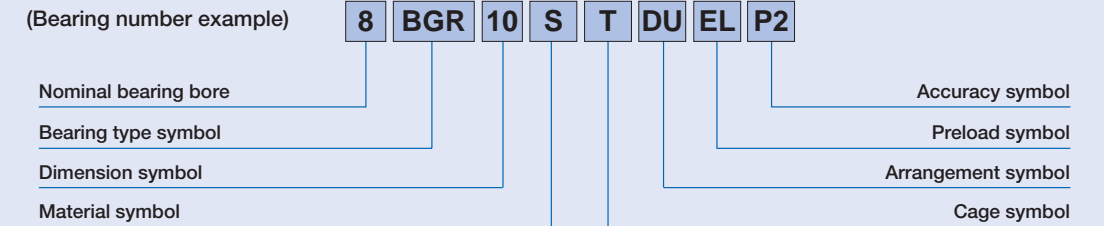

			Reference pages														
8	Nominal bearing bore	Bore diameter (mm)	82-84														
BGR	Bearing type	BGR: 15° contact angle	42-43, 48														
10	Dimension	10: 10 series, 19: 19 series, 02: 02 series	42-43, 80														
S	Material	<table border="1"> <thead> <tr> <th rowspan="2">Type</th> <th colspan="2">Material</th> </tr> <tr> <th>Rings</th> <th>Rolling elements</th> </tr> </thead> <tbody> <tr> <td>S</td> <td>Bearing steel (SUJ2)</td> <td>Bearing steel (SUJ2)</td> </tr> <tr> <td>H</td> <td>Bearing steel (SUJ2)</td> <td>Ceramics (Si₃N₄)</td> </tr> <tr> <td>X</td> <td>Heat resistant steel (SHX)</td> <td>Ceramics (Si₃N₄)</td> </tr> </tbody> </table>	Type	Material		Rings	Rolling elements	S	Bearing steel (SUJ2)	Bearing steel (SUJ2)	H	Bearing steel (SUJ2)	Ceramics (Si ₃ N ₄)	X	Heat resistant steel (SHX)	Ceramics (Si ₃ N ₄)	14-17 29
		Type		Material													
			Rings	Rolling elements													
		S	Bearing steel (SUJ2)	Bearing steel (SUJ2)													
H	Bearing steel (SUJ2)	Ceramics (Si ₃ N ₄)															
X	Heat resistant steel (SHX)	Ceramics (Si ₃ N ₄)															
T	Cage	T: phenolic resin cage with outer ring guide; operational temperature limit = 120°C	18-19														
DU	Arrangement	SU: universal arrangement (single row) DU: universal arrangement (double row)	42-43 148-151														
EL	Preload	EL: extra light preload	42-43 152-155, 165														
P2	Accuracy	P2: ISO Class 2, P4: ISO Class 4 P3: special class (dimensional accuracy: ISO Class 4; rotating accuracy: ISO Class 2)	176-179														

1. ANGULAR CONTACT BALL BEARINGS

Ultra High Precision Angular Contact Ball Bearings (ROBUST Series—BGR)

BGR19 Series

Bore Diameter 10-25 mm

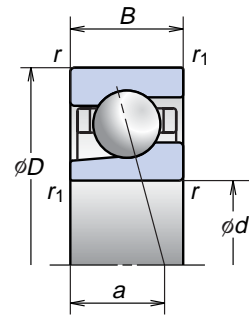

Bearing Numbers	Boundary Dimensions (mm)					Basic Load Ratings (kN)		Permissible Axial Load ⁽¹⁾ (kN)	Effective Load Center (mm) a	Mass (kg) (approx.)	Limiting Speeds ⁽²⁾ (min ⁻¹)		
	d	D	B	r (min.)	r ₁ (min.)	C _r (Dynamic)	C _{0r} (Static)				Grease	Oil	
10BGR19S	10	22	6	0.3	0.15	2.03	0.78	0.93	5.1	0.010	100 000	138 000	
10BGR19H	10	22	6	0.3	0.15						0.61	119 000	175 000
10BGR19X	10	22	6	0.3	0.15						0.009	138 000	188 000
12BGR19S	12	24	6	0.3	0.15	2.28	0.95	1.14	5.4	0.011	88 900	123 000	
12BGR19H	12	24	6	0.3	0.15						0.74	106 000	156 000
12BGR19X	12	24	6	0.3	0.15						0.010	123 000	167 000
15BGR19S	15	28	7	0.3	0.15	3.25	1.35	1.67	6.4	0.016	74 500	103 000	
15BGR19H	15	28	7	0.3	0.15						1.09	88 400	131 000
15BGR19X	15	28	7	0.3	0.15						0.014	103 000	140 000
17BGR19S	17	30	7	0.3	0.15	3.40	1.50	1.86	6.6	0.017	68 100	93 700	
17BGR19H	17	30	7	0.3	0.15						1.21	80 900	120 000
17BGR19X	17	30	7	0.3	0.15						0.015	93 700	128 000
20BGR19S	20	37	9	0.3	0.15	4.75	2.16	2.66	8.3	0.036	56 200	77 200	
20BGR19H	20	37	9	0.3	0.15						1.73	66 700	98 300
20BGR19X	20	37	9	0.3	0.15						0.033	77 200	106 000
25BGR19S	25	42	9	0.3	0.15	5.40	2.76	3.40	9.0	0.043	47 800	65 700	
25BGR19H	25	42	9	0.3	0.15						2.22	56 800	83 600
25BGR19X	25	42	9	0.3	0.15						0.039	65 700	89 600

⁽¹⁾ For permissible axial load, please refer to Page 147.

⁽²⁾ For application of limiting speeds, please refer to Page 170.

Note: Bearing type BGR: nominal contact angle 15°

BGR10 Series

Bore Diameter 6-25 mm

- For additional information: Page No.
- Dynamic equivalent load139
 - Static equivalent load146
 - Preload and rigidity152
 - Abutment and fillet dimensions186
 - Nozzle position192
 - Quantity of packed grease175

Bearing Numbers	Boundary Dimensions (mm)					Basic Load Ratings (kN)		Permissible Axial Load ⁽¹⁾ (kN)	Effective Load Center (mm) a	Mass (kg) (approx.)	Limiting Speeds ⁽²⁾ (min ⁻¹)		
	d	D	B	r (min.)	r ₁ (min.)	C _r (Dynamic)	C _{0r} (Static)				Grease	Oil	
6BGR10S	6	17	6	0.3	0.15	1.42	0.43	0.51	4.5	0.006	140 000	192 000	
6BGR10H	6	17	6	0.3	0.15						0.005	166 000	244 000
6BGR10X	6	17	6	0.3	0.15						0.009	192 000	261 000
7BGR10S	7	19	6	0.3	0.15	1.60	0.52	0.62	4.7	0.008	124 000	170 000	
7BGR10H	7	19	6	0.3	0.15						0.007	147 000	216 000
7BGR10X	7	19	6	0.3	0.15						0.010	170 000	231 000
8BGR10S	8	22	7	0.3	0.15	2.37	0.80	0.97	5.5	0.012	107 000	147 000	
8BGR10H	8	22	7	0.3	0.15						0.011	127 000	187 000
8BGR10X	8	22	7	0.3	0.15						0.014	147 000	200 000
10BGR10S	10	26	8	0.3	0.15	3.50	1.27	1.55	6.4	0.019	88 900	123 000	
10BGR10H	10	26	8	0.3	0.15						1.00	106 000	156 000
10BGR10X	10	26	8	0.3	0.15						0.016	123 000	167 000
12BGR10S	12	28	8	0.3	0.15	3.85	1.48	1.80	6.7	0.021	80 000	110 000	
12BGR10H	12	28	8	0.3	0.15						1.17	95 000	140 000
12BGR10X	12	28	8	0.3	0.15						0.018	110 000	150 000
15BGR10S	15	32	9	0.3	0.15	4.20	1.72	2.12	7.6	0.029	68 100	93 700	
15BGR10H	15	32	9	0.3	0.15						1.37	80 900	120 000
15BGR10X	15	32	9	0.3	0.15						0.026	93 700	128 000
17BGR10S	17	35	10	0.3	0.15	4.45	1.93	2.39	8.5	0.038	61 600	84 700	
17BGR10H	17	35	10	0.3	0.15						1.55	73 100	108 000
17BGR10X	17	35	10	0.3	0.15						0.035	84 700	116 000
20BGR10S	20	42	12	0.6	0.3	7.45	3.35	4.10	10.2	0.066	51 700	71 000	
20BGR10H	20	42	12	0.6	0.3						2.67	61 300	90 400
20BGR10X	20	42	12	0.6	0.3						0.059	71 000	96 800
25BGR10S	25	47	12	0.6	0.3	7.90	3.75	4.65	10.8	0.076	44 500	61 200	
25BGR10H	25	47	12	0.6	0.3						3.05	52 800	77 800
25BGR10X	25	47	12	0.6	0.3						0.068	61 200	83 400

⁽¹⁾ For permissible axial load, please refer to Page 147.

⁽²⁾ For application of limiting speeds, please refer to Page 170.

Note: Bearing type BGR: nominal contact angle 15°

1. ANGULAR CONTACT BALL BEARINGS

Ultra High Precision Angular Contact Ball Bearings (ROBUST Series—BGR)

BGR02 Series

Bore Diameter 10-25 mm

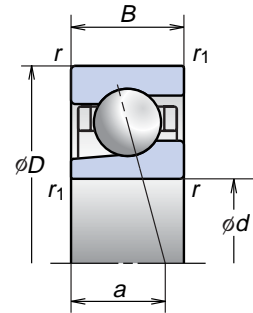

Bearing Numbers	Boundary Dimensions (mm)					Basic Load Ratings (kN)		Permissible Axial Load ⁽¹⁾ (kN)	Effective Load Center (mm) <i>a</i>	Mass (kg) (approx.)	Limiting Speeds ⁽²⁾ (min ⁻¹)	
	<i>d</i>	<i>D</i>	<i>B</i>	<i>r</i> (min.)	<i>r</i> ₁ (min.)	<i>C</i> _r (Dynamic)	<i>C</i> _{0r} (Static)				Grease	Oil
10BGR02S	10	30	9	0.6	0.3	3.60	1.33	1.62	7.2	0.032	80 000	110 000
10BGR02H	10	30	9	0.6	0.3			1.06		0.029	95 000	140 000
10BGR02X	10	30	9	0.6	0.3			1.06		0.029	110 000	150 000
12BGR02S	12	32	10	0.6	0.3	5.30	1.99	2.46	7.9	0.036	72 800	100 000
12BGR02H	12	32	10	0.6	0.3			1.60		0.032	86 400	128 000
12BGR02X	12	32	10	0.6	0.3			1.60		0.032	100 000	137 000
15BGR02S	15	35	11	0.6	0.3	5.80	2.34	2.90	8.8	0.045	64 000	88 000
15BGR02H	15	35	11	0.6	0.3			1.89		0.040	76 000	112 000
15BGR02X	15	35	11	0.6	0.3			1.89		0.040	88 000	120 000
17BGR02S	17	40	12	0.6	0.3	7.25	2.98	3.65	9.8	0.065	56 200	77 200
17BGR02H	17	40	12	0.6	0.3			2.39		0.057	66 700	98 300
17BGR02X	17	40	12	0.6	0.3			2.39		0.057	77 200	106 000
20BGR02S	20	47	14	1.0	0.6	9.70	4.10	5.10	11.5	0.103	47 800	65 700
20BGR02H	20	47	14	1.0	0.6			3.30		0.091	56 800	83 600
20BGR02X	20	47	14	1.0	0.6			3.30		0.091	65 700	89 600
25BGR02S	25	52	15	1.0	0.6	11.1	5.20	6.45	12.7	0.127	41 600	57 200
25BGR02H	25	52	15	1.0	0.6			4.20		0.112	49 400	72 800
25BGR02X	25	52	15	1.0	0.6			4.20		0.112	57 200	78 000

⁽¹⁾ For permissible axial load, please refer to Page 147.

⁽²⁾ For application of limiting speeds, please refer to Page 170.

Note: Bearing type BGR: nominal contact angle 15°



Double-Row Cylindrical Roller Bearings

High Rigidity Series



Single-Row Cylindrical Roller Bearings

Standard Series



Ultra High-Speed Single-Row Cylindrical Roller Bearings

ROBUST Series

Cylindrical Roller Bearings

Cylindrical Roller BearingsP88-97

Features

Numbering System

Bearing Tables

Double-Row Cylindrical Roller Bearings (High Rigidity Series)

30 Series

39 Series

49 Series

Single-Row Cylindrical Roller Bearings (Standard Series)

10 Series

Ultra High-Speed Single-Row Cylindrical Roller Bearings (ROBUST Series)

10 Series

Double-Row Cylindrical Roller Bearings (Low Heat Generation Series)

30 Series

Ultra High-Speed Single-Row Cylindrical Roller Bearings (Low Heat Generation Series)

10 Series

Cylindrical Roller Bearings

Features

The high rigidity of NSK's double-row cylindrical roller bearings makes them a perfect match for use in machine tool spindles. Typically, single-row and double-row cylindrical roller bearings have either a cylindrical bore or a tapered bore. Double-row cylindrical roller bearings with a tapered bore are often mounted to the main shaft as a fixed-end bearing. Simplicity in design and the ability to adjust radial internal clearance after mounting continue to make these bearings popular among machine tool users.

NSK offers several types of cylindrical roller bearings. Users can request an E44 configuration, which includes both lubrication holes and a machined lubrication groove on the outside surface of the outer ring. Types of bearings include the NNU type, which features double ribbed outer rings, and the NN type, which features excellent grease discharge during the initial running-in period, and helps promote steady oil flow throughout the bearing.

For thin section type bearings, the narrower NN39 series is more suitable than the wider NN49 series due to less heat generation and greater roller stability. Machined brass cages are most common with cylindrical roller bearings. NSK offers a roller guided PPS (polyphenylene sulfide) resin cage for the NN30 series, and a PEEK (polyether ether ketone) resin cage, which is guided by the outer ring, for N10 series of ultra high-speed single-row cylindrical roller bearings.

Bearing type	Cage symbol	Specification	Available size
NN	MB	Roller guided machined brass cage	NN3005, NN3026-NN3040 NN3920-NN3956 NN4920-NN4940
	TB	Roller guided PPS resin cage	NN3006-NN3024
NNU	MB	Roller guided machined brass cage	NNU4920-NNU4940
N	MR	Roller guided machined brass cage	N1006-N1028
	TP	Outer ring guided PEEK resin cage	N1009-N1017

Specification of Bore and Lubrication Holes

Fig. 2.1

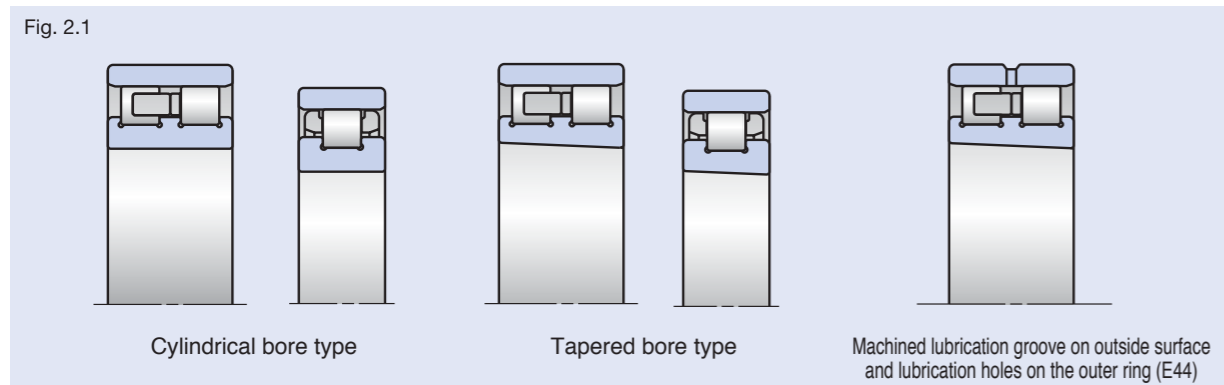

Double-row and single-row bearings available with cylindrical bore or tapered bore. Double-row cylindrical roller bearings available with a machined lubrication groove and lubrication holes (the best solution for oil lubrication).

Bearing Type and Dimension Series

Fig. 2.2

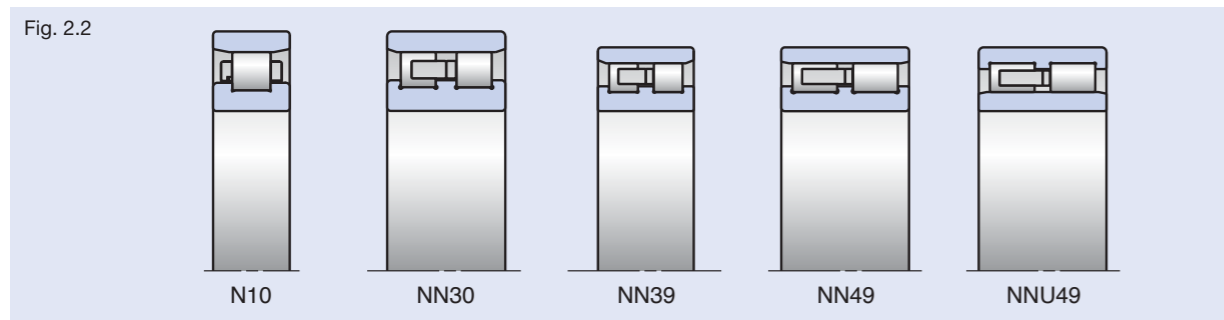

Numbering System of Double-Row Cylindrical Roller Bearings (High Rigidity Series)

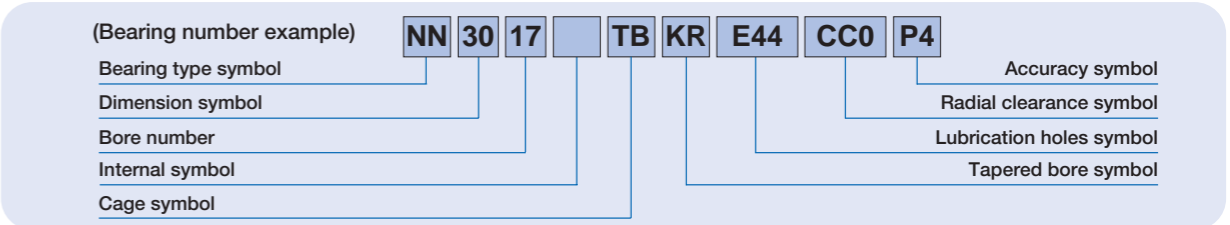

Symbol	Meaning	Reference pages
NN	Bearing type : NN: double-row cylindrical roller bearing with triple-ribbed inner ring, NNU: double-row cylindrical roller bearing with triple-ribbed outer ring	44-45, 88
30	Dimension : 30: 30 series, 39: 39 series, 49: 49 series	44-45, 88
17	Bore number : Bearing bore = bore number · 5 (mm)	90-93
	Internal symbol : No symbol: standard type Z: low heat generation type	96
TB	Cage : TB: roller guided PPS resin cage; operational temperature limit = 220°C MB: roller guided machined brass cage; operational temperature limit = 300°C	18-19 26-27
KR	Tapered bore : KR: 1/12 tapered bore (Leave this symbol blank for cylindrical bore)	180-181
E44	Lubrication holes : E44: outer ring with machined lubrication groove and lubrication holes (Leave this symbol blank for no lubrication holes)	90-93
CC0	Radial clearance : CC1: standard clearance for cylindrical bore CC0: standard clearance for tapered bore CCG: special radial clearance	44-45 169
P4	Accuracy : P2: ISO Class 2, P4: ISO Class 4, P4Y: special class (Bore diameter and outside diameter are exclusive to NSK. All others are ISO Class 4.)	151 176-181

Numbering System of Single-Row Cylindrical Roller Bearings (Standard Series and ROBUST Series)

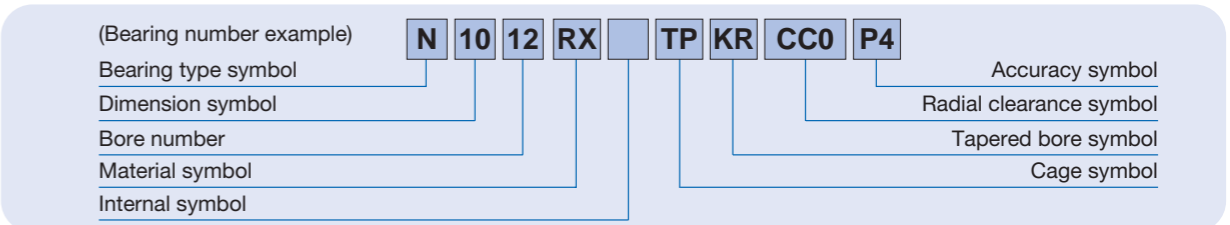

Symbol	Meaning	Reference pages
N	Bearing type : N: single-row cylindrical roller bearing with double-ribbed inner ring	44-45, 88
10	Dimension : 10: 10 series	44-45, 88
12	Bore number : Bearing bore = bore number · 5 (mm)	94-95
RX	Material : No symbol indicates our standard cylindrical roller bearing material (rings and rolling elements are SUJ2 bearing steel). RS-RX-RXH: ultra high-speed single-row cylindrical roller bearing (ROBUST series)	14-17 26-27
	Internal symbol : No symbol: Standard type Z: Low heat generation type	97
TP	Cage : TP: outer ring guided PEEK resin cage; operational temperature limit = 240°C MR: roller guided machined brass cage; operational temperature limit = 300°C	18-19
KR	Tapered bore : KR: 1/12 tapered bore (Leave this symbol blank for cylindrical bore)	180-181
CC0	Radial clearance : CC1: standard clearance for cylindrical bore CC0: standard clearance for tapered bore CCG: special radial clearance	44-45 169
P4	Accuracy : P2: ISO Class 2, P4: ISO Class 4, P4Y: special class (Bore diameter and outside diameter are exclusive to NSK. All others are ISO Class 4.)	151 176-181

2. CYLINDRICAL ROLLER BEARINGS

Double-Row Cylindrical Roller Bearings (High Rigidity Series)

30 Series

Bore Diameter 25-200 mm

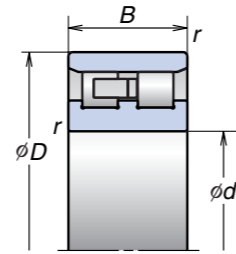

*Cylindrical Bore

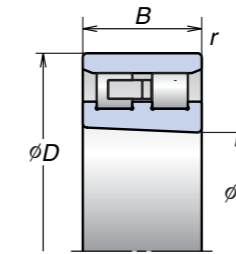

Tapered Bore

Bearing Numbers	Boundary Dimensions (mm)				Basic Load Ratings (kN)		Circumscribed circle diameter of roller (mm) (reference)	Mass (kg) (approx.)	Limiting Speeds (1) (min ⁻¹)	
	d	D	B	r	C _r (Dynamic)	C _{0r} (Static)			Grease	Oil
NN3005MBKR	25	47	16	0.6	25.8	30.0	41.3	0.127	20 900	25 000
NN3006MBKR	30	55	19	1.0	31.0	37.0	48.5	0.198	17 700	21 200
NN3006TBKR	30	55	19	1.0	31.0	37.0	48.5	0.172	20 000	23 600
NN3007MBKR	35	62	20	1.0	39.5	50.0	55	0.258	15 500	18 600
NN3007TBKR	35	62	20	1.0	39.5	50.0	55	0.224	17 600	20 700
NN3008MBKR	40	68	21	1.0	43.5	55.5	61	0.309	13 900	16 700
NN3008TBKR	40	68	21	1.0	43.5	55.5	61	0.283	15 800	18 600
NN3009MBKR	45	75	23	1.0	52.0	68.5	67.5	0.407	12 500	15 000
NN3009TBKR	45	75	23	1.0	50.0	65.5	67.5	0.373	14 200	16 700
NN3010MBKR	50	80	23	1.0	53.0	72.5	72.5	0.436	11 600	13 900
NN3010TBKR	50	80	23	1.0	53.0	72.5	72.5	0.402	13 100	15 400
NN3011MBKR	55	90	26	1.1	69.5	96.5	81	0.647	10 400	12 500
NN3011TBKR	55	90	26	1.1	69.5	96.5	81	0.592	11 800	13 800
NN3012MBKR	60	95	26	1.1	73.5	106	86.1	0.693	9 700	11 700
NN3012TBKR	60	95	26	1.1	73.5	106	86.1	0.635	11 000	13 000
NN3013MBKR	65	100	26	1.1	77.0	116	91	0.741	9 100	11 000
NN3013TBKR	65	100	26	1.1	77.0	116	91	0.681	10 400	12 200
NN3014MBKR	70	110	30	1.1	97.5	143	100	1.060	8 000	10 000
NN3014TBKR	70	110	30	1.1	97.5	143	100	0.988	9 500	11 200
NN3015MBKR	75	115	30	1.1	96.5	149	105	1.110	7 900	9 500
NN3015TBKR	75	115	30	1.1	96.5	149	105	1.030	9 000	10 600
NN3016MBKR	80	125	34	1.1	119	186	113	1.540	7 400	8 800
NN3016TBKR	80	125	34	1.1	119	186	113	1.440	8 300	9 800
NN3017MBKR	85	130	34	1.1	122	194	118	1.630	7 000	8 400
NN3017TBKR	85	130	34	1.1	122	194	118	1.520	8 000	9 400

(1) For application of limiting speeds, please refer to Page 170.

*For the cylindrical bore type, eliminate the "KR" symbol and leave this symbol blank.

30 Series (continued)

Bearing Numbers	Boundary Dimensions (mm)				Basic Load Ratings (kN)		Circumscribed circle diameter of roller (mm) (reference)	Mass (kg) (approx.)	Limiting Speeds (1) (min ⁻¹)	
	d	D	B	r	C _r (Dynamic)	C _{0r} (Static)			Grease	Oil
NN3018MBKR	90	140	37	1.5	143	228	127	2.090	6 600	7 900
NN3018TBKR	90	140	37	1.5	143	228	127	1.930	7 400	8 700
NN3019MBKR	95	145	37	1.5	146	238	132	2.190	6 300	7 500
NN3019TBKR	95	145	37	1.5	146	238	132	2.030	7 100	8 400
NN3020MBKR	100	150	37	1.5	149	247	137	2.280	6 000	7 200
NN3020TBKR	100	150	37	1.5	149	247	137	2.120	6 800	8 000
NN3021MBKR	105	160	41	2.0	192	310	146	2.880	5 700	6 800
NN3021TBKR	105	160	41	2.0	192	310	146	2.690	6 500	7 600
NN3022MBKR	110	170	45	2.0	222	360	155	3.710	5 400	6 500
NN3022TBKR	110	170	45	2.0	222	360	155	3.440	6 100	7 200
NN3024MBKR	120	180	46	2.0	233	390	165	4.040	5 000	6 000
NN3024TBKR	120	180	46	2.0	233	390	165	3.750	5 700	6 700
NN3026MBKR	130	200	52	2.0	284	475	182	5.880	4 600	5 500
NN3028MBKR	140	210	53	2.0	298	515	192	6.340	4 300	5 200
NN3030MBKR	150	225	56	2.1	335	585	206	7.760	4 000	4 800
NN3032MBKR	160	240	60	2.1	375	660	219	9.410	3 800	4 500
NN3034MBKR	170	260	67	2.1	450	805	236	12.80	3 500	4 200
NN3036MBKR	180	280	74	2.1	565	995	255	16.80	3 300	4 000
NN3038MBKR	190	290	75	2.1	595	1 080	265	17.80	3 200	3 800
NN3040MBKR	200	310	82	2.1	655	1 170	282	22.70	3 000	3 600

(1) For application of limiting speeds, please refer to Page 170.

Lubrication Holes Dimensions (E44 Specification)

Outer Ring Width		Lubrication Hole dh	Machined Lubrication Groove W	Number of Holes m
over	incl.			
-	30	2	3.5	4
30	40	2.5	5	
40	50	3	6	
50	60	4	8	
60	80	5	9	
80	120	6	12	
120	160	8	15	
160	200	10	18	
200	-	12	20	

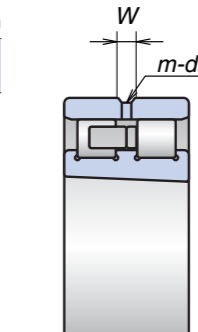

For additional information: Page No.

- Dynamic equivalent load139
- Static equivalent load146
- Radial clearance169
- Abutment and fillet dimensions186
- Nozzle position192
- Quantity of packed grease175

Cylindrical Roller Bearings Double Row

2. CYLINDRICAL ROLLER BEARINGS

Double-Row Cylindrical Roller Bearings (High Rigidity Series)

39 Series

Bore Diameter 100-280 mm

49 Series

Bore Diameter 100-200 mm

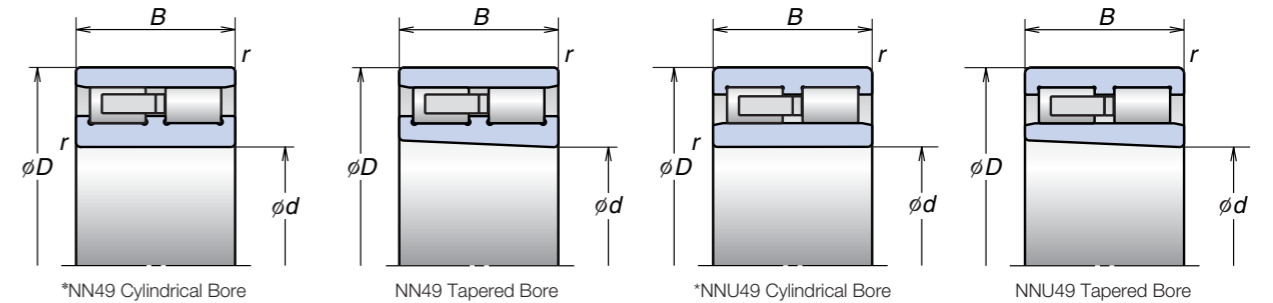
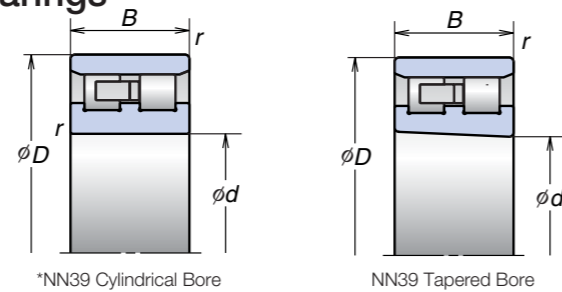

Bearing Numbers	Boundary Dimensions (mm)				Basic Load Ratings (kN)		Circumscribed circle diameter of roller (mm) (reference)	Mass (kg) (approx.)	Limiting Speeds (1) (min ⁻¹)	
	<i>d</i>	<i>D</i>	<i>B</i>	<i>r</i>	<i>C_r</i> (Dynamic)	<i>C_{0r}</i> (Static)			Grease	Oil
NN3920MBKR	100	140	30	1.1	106	182	130	1.32	6 300	7 500
NN3921MBKR	105	145	30	1.1	110	194	135	1.50	6 000	7 200
NN3922MBKR	110	150	30	1.1	114	207	140	1.41	5 800	7 000
NN3924MBKR	120	165	34	1.1	138	251	153.5	1.99	5 300	6 400
NN3926MBKR	130	180	37	1.5	173	325	167	2.64	4 900	5 900
NN3928MBKR	140	190	37	1.5	201	375	178	2.97	4 600	5 500
NN3930MBKR	150	210	45	2.0	262	490	195	4.47	4 200	5 000
NN3932MBKR	160	220	45	2.0	271	520	205	4.75	4 000	4 800
NN3934MBKR	170	230	45	2.0	280	550	215	5.01	3 800	4 500
NN3936MBKR	180	250	52	2.0	340	655	232	7.76	3 500	4 200
NN3938MBKR	190	260	52	2.0	345	680	243.5	7.46	3 400	4 000
NN3940MBKR	200	280	60	2.1	420	815	259	10.60	3 200	3 800
NN3944MBKR	220	300	60	2.1	440	895	279	11.40	2 900	3 500
NN3948MBKR	240	320	60	2.1	460	975	300	12.10	2 700	3 300
NN3952MBKR	260	360	75	2.1	670	1 380	335	21.40	2 500	3 000
NN3956MBKR	280	380	75	2.1	695	1 460	355	22.70	2 300	2 800

Bearing Numbers	Boundary Dimensions (mm)				Basic Load Ratings (kN)		Circumscribed circle diameter of roller (mm) (reference) (inscribed circle diameter in the case of NNU type)	Mass (kg) (approx.)	Limiting Speed (1) (min ⁻¹)	
	<i>d</i>	<i>D</i>	<i>B</i>	<i>r</i>	<i>C_r</i> (Dynamic)	<i>C_{0r}</i> (Static)			Grease	Oil
NN4920MBKR	100	140	40	1.1	155	295	130	1.76	6 300	7 500
NNU4920MBKR	100	140	40	1.1	155	295	112	1.90	6 300	7 500
NN4921MBKR	105	145	40	1.1	161	315	135	2.00	6 000	7 200
NNU4921MBKR	105	145	40	1.1	161	315	117	1.99	6 000	7 200
NN4922MBKR	110	150	40	1.1	167	335	140	2.10	5 800	7 000
NNU4922MBKR	110	150	40	1.1	167	335	122	2.07	5 800	7 000
NN4924MBKR	120	165	45	1.1	183	360	153.5	2.87	5 300	6 400
NNU4924MBKR	120	165	45	1.1	183	360	133.5	2.85	5 300	6 400
NN4926MBKR	130	180	50	1.5	274	545	168	3.84	4 900	5 900
NNU4926MBKR	130	180	50	1.5	274	545	144	3.85	4 900	5 900
NN4928MBKR	140	190	50	1.5	283	585	178	4.07	4 600	5 500
NNU4928MBKR	140	190	50	1.5	283	585	154	4.08	4 600	5 500
NN4930MBKR	150	210	60	2.0	350	715	195	6.36	4 200	5 000
NNU4930MBKR	150	210	60	2.0	350	715	167	6.39	4 200	5 000
NN4932MBKR	160	220	60	2.0	365	760	205	6.77	4 000	4 800
NNU4932MBKR	160	220	60	2.0	365	760	177	6.76	4 000	4 800
NN4934MBKR	170	230	60	2.0	375	805	215	7.13	3 800	4 500
NNU4934MBKR	170	230	60	2.0	375	805	187	7.12	3 800	4 500
NN4936MBKR	180	250	69	2.0	480	1 020	232	10.4	3 500	4 200
NNU4936MBKR	180	250	69	2.0	480	1 020	200	10.4	3 500	4 200
NN4938MBKR	190	260	69	2.0	485	1 060	243.5	10.9	3 400	4 000
NNU4938MBKR	190	260	69	2.0	485	1 060	211.5	10.9	3 400	4 000
NN4940MBKR	200	280	80	2.1	570	1 220	259	15.3	3 200	3 800
NNU4940MBKR	200	280	80	2.1	570	1 220	223	15.3	3 200	3 800

(1) For application of limiting speeds, please refer to Page 170.
*For the cylindrical bore type, eliminate the "KR" symbol and leave this symbol blank.

Lubrication Holes Dimensions (E44 Specification) Unit: mm

Outer Ring Width		Lubrication Hole <i>dh</i>	Machined Lubrication Groove <i>W</i>	Number of Holes <i>m</i>
over	incl.			
-	30	2	3.5	4
30	40	2.5	5	
40	50	3	6	
50	60	4	8	
60	80	5	9	
80	120	6	12	
120	160	8	15	
160	200	10	18	
200	-	12	20	

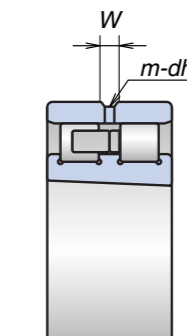

- For additional information: Page No.
- Dynamic equivalent load139
 - Static equivalent load146
 - Radial clearance169
 - Abutment and fillet dimensions186
 - Nozzle position192
 - Quantity of packed grease175

2. CYLINDRICAL ROLLER BEARINGS

Single-Row Cylindrical Roller Bearings (Standard Series)

10 Series

Bore Diameter 30-140 mm

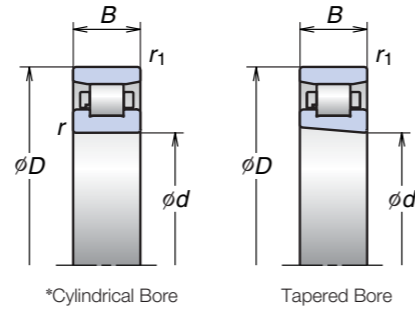

Bearing Numbers	Boundary Dimensions (mm)					Basic Load Ratings (kN)		Circumscribed circle diameter of roller (mm) (reference)	Mass (kg) (approx.)	Limiting Speeds (1) (min ⁻¹)	
	d	D	B	r	r_1	C_r (Dynamic)	C_{0r} (Static)			Grease	Oil
N1006MR1KR	30	55	13	1.0	0.6	19.7	19.6	48.5	0.133	19 000	31 000
N1007MRKR	35	62	14	1.0	0.6	22.6	23.2	55	0.153	17 000	27 000
N1008MRKR	40	68	15	1.0	0.6	27.3	29.0	61	0.192	15 000	25 000
N1009MRKR	45	75	16	1.0	0.6	32.5	35.5	67.5	0.318	14 000	22 000
N1010MRKR	50	80	16	1.0	0.6	32.0	36.0	72.5	0.339	13 000	20 000
N1011BMR1KR	55	90	18	1.1	1.0	37.5	44.0	81	0.487	12 000	18 000
N1012BMR1KR	60	95	18	1.1	1.0	40.0	48.5	86.1	0.519	11 000	17 000
N1013BMR1KR	65	100	18	1.1	1.0	41.0	51.0	91	0.541	10 000	16 000
N1014BMR1KR	70	110	20	1.1	1.0	50.0	63.0	100	0.752	9 000	15 000
N1015MRKR	75	115	20	1.1	1.0	60.0	74.5	105	0.935	8 500	13 700
N1016BMR1KR	80	125	22	1.1	1.0	63.5	82.0	113	1.038	7 900	12 700
N1017BMR1KR	85	130	22	1.1	1.0	65.0	86.0	118	1.067	7 500	12 100
N1018MRKR	90	140	24	1.5	1.1	88.0	114	127	1.200	7 000	11 400
N1019BMR1KR	95	145	24	1.5	1.1	83.0	114	132	1.260	6 700	10 900
N1020MRKR	100	150	24	1.5	1.1	93.0	126	137	1.320	6 400	10 400
N1021MRKR	105	160	26	2.0	1.1	109	149	145.5	1.670	6 100	9 900
N1022BMR1KR	110	170	28	2.0	1.1	126	173	155	2.070	5 800	9 300
N1024MRKR	120	180	28	2.0	1.1	139	191	165	2.190	5 400	8 700
N1026MRKR	130	200	33	2.0	1.1	172	238	182	3.320	4 900	7 900
N1028BMR1KR	140	210	33	2.0	1.1	164	240	192	3.810	4 600	7 500

(1) For application of limiting speeds, please refer to Page 170.
*For the cylindrical bore type, eliminate the "KR" symbol and leave this symbol blank.

Ultra High-Speed Single-Row Cylindrical Roller Bearings (ROBUST Series)

10 Series

Bore Diameter 45-85 mm

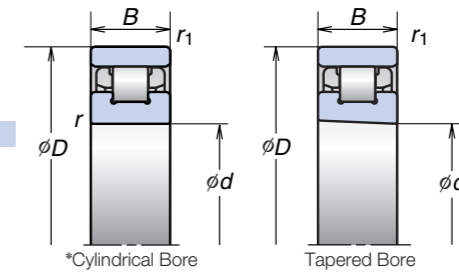

- For additional information: Page No.
- Dynamic equivalent load139
 - Static equivalent load146
 - Radial clearance169
 - Abutment and fillet dimensions186
 - Nozzle position192
 - Quantity of packed grease175

Bearing Numbers	Boundary Dimensions (mm)					Basic Load Ratings (kN)		Circumscribed circle diameter of roller (mm) (reference)	Mass (kg) (approx.)	Limiting Speeds (1) (min ⁻¹)	
	d	D	B	r	r_1	C_r (Dynamic)	C_{0r} (Static)			Grease	Oil
N1009RSTPKR	45	75	16	1.0	0.6	24.6	26.1	67.5	0.262	16 000	23 000
N1009RSTPKR	45	75	16	1.0	0.6	24.6	26.1	67.5	0.262	21 000	30 000
N1009RXHTPKR	45	75	16	1.0	0.6	24.6	26.1	67.5	0.228	23 000	36 000
N1010RSTPKR	50	80	16	1.0	0.6	28.8	33.0	72.5	0.283	15 000	21 000
N1010RSTPKR	50	80	16	1.0	0.6	28.8	33.0	72.5	0.283	20 000	27 000
N1010RXHTPKR	50	80	16	1.0	0.6	28.8	33.0	72.5	0.246	21 000	34 000
N1011RSTPKR	55	90	18	1.1	1.0	35.0	39.5	81	0.372	13 000	19 000
N1011RSTPKR	55	90	18	1.1	1.0	35.0	39.5	81	0.372	18 000	25 000
N1011RXHTPKR	55	90	18	1.1	1.0	35.0	39.5	81	0.324	19 000	30 000
N1012RSTPKR	60	95	18	1.1	1.0	37.5	44.0	86.1	0.442	12 000	18 000
N1012RSTPKR	60	95	18	1.1	1.0	37.5	44.0	86.1	0.442	17 000	23 000
N1012RXHTPKR	60	95	18	1.1	1.0	37.5	44.0	86.1	0.385	18 000	28 000
N1013RSTPKR	65	100	18	1.1	1.0	39.5	49.0	91	0.518	11 000	17 000
N1013RSTPKR	65	100	18	1.1	1.0	39.5	49.0	91	0.518	16 000	22 000
N1013RXHTPKR	65	100	18	1.1	1.0	39.5	49.0	91	0.451	17 000	27 000
N1014RSTPKR	70	110	20	1.1	1.0	46.5	57.0	100	0.648	10 000	16 000
N1014RSTPKR	70	110	20	1.1	1.0	46.5	57.0	100	0.648	15 000	20 000
N1014RXHTPKR	70	110	20	1.1	1.0	46.5	57.0	100	0.564	16 000	24 000
N1015RSTPKR	75	115	20	1.1	1.0	49.5	63.0	105	0.672	9 900	15 000
N1015RSTPKR	75	115	20	1.1	1.0	49.5	63.0	105	0.672	14 000	19 000
N1015RXHTPKR	75	115	20	1.1	1.0	49.5	63.0	105	0.585	15 000	23 000
N1016RSTPKR	80	125	22	1.1	1.0	61.5	81.5	113	0.926	9 200	14 000
N1016RSTPKR	80	125	22	1.1	1.0	61.5	81.5	113	0.926	13 000	17 000
N1016RXHTPKR	80	125	22	1.1	1.0	61.5	81.5	113	0.812	14 000	21 000
N1017RSTPKR	85	130	22	1.1	1.0	65.0	86.0	118	0.943	8 800	13 000
N1017RSTPKR	85	130	22	1.1	1.0	65.0	86.0	118	0.943	12 000	17 000
N1017RXHTPKR	85	130	22	1.1	1.0	65.0	86.0	118	0.826	13 000	20 000

(1) For application of limiting speeds, please refer to Page 170.
*For the cylindrical bore type, eliminate the "KR" symbol and leave this symbol blank.

2. CYLINDRICAL ROLLER BEARINGS

Double-Row Cylindrical Roller Bearings (Low Heat Generation Series)

30 Series

Bore Diameter 30-120 mm

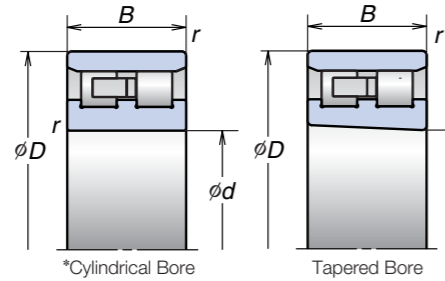

- For additional information: Page No.
- Dynamic equivalent load139
 - Static equivalent load146
 - Radial clearance169
 - Abutment and fillet dimensions ...186
 - Nozzle position192
 - Quantity of packed grease175

Bearing Numbers	Boundary Dimensions (mm)				Basic Load Ratings (kN)		Circumscribed circle diameter of roller (mm) (reference)	Mass (kg) (approx.)	Limiting Speeds (1) (min ⁻¹)	
	d	D	B	r	C _r (Dynamic)	C _{0r} (Static)			Grease	Oil
NN3006ZTBKR	30	55	19	1.0	18.3	18.6	48.5	0.154	23 300	27 900
NN3007ZTBKR	35	62	20	1.0	23.3	25.0	55.0	0.198	20 400	24 500
NN3008ZTBKR	40	68	21	1.0	25.7	27.7	61.0	0.250	18 300	22 000
NN3009ZTBKR	45	75	23	1.0	29.7	32.5	67.5	0.331	16 500	19 800
NN3010ZTBKR	50	80	23	1.0	31.5	36.5	72.5	0.356	15 300	18 300
NN3011ZTBKR	55	60	26	1.1	41.0	48.5	81.0	0.523	13 700	16 400
NN3012ZTBKR	60	95	26	1.1	43.5	53.0	86.1	0.560	12 800	15 400
NN3013ZTBKR	65	100	26	1.1	46.0	58.0	91.0	0.600	12 000	14 500
NN3014ZTBKR	70	110	30	1.1	58.0	74.0	100.0	0.873	11 000	13 200
NN3015ZTBKR	75	115	30	1.1	57.5	74.5	105.0	0.915	10 400	12 500
NN3016ZTBKR	80	125	34	1.1	71.0	93.0	113.0	1.282	9 700	11 700
NN3017ZTBKR	85	130	34	1.1	74.5	101	118.0	1.350	9 300	11 100
NN3018ZTBKR	90	140	37	1.5	85.0	114	127.0	1.719	8 600	10 300
NN3019ZTBKR	95	145	37	1.5	89.0	123	132.0	1.803	8 300	9 900
NN3020ZTBKR	100	150	37	1.5	93.5	133	137.0	1.877	7 900	9 500
NN3021ZTBKR	105	160	41	2.0	118	161	146.0	2.342	7 500	9 000
NN3022ZTBKR	110	170	45	2.0	136	188	155.0	3.006	7 100	8 500
NN3024ZTBKR	120	180	46	2.0	142	203	165.0	3.282	6 600	7 900

(1) For application of limiting speeds, please refer to Page 170.
*For the cylindrical bore type, eliminate the "KR" symbol and leave this symbol blank.

Ultra High-Speed Single-Row Cylindrical Roller Bearings (Low Heat Generation Series)

10 Series

Bore Diameter 45-85 mm

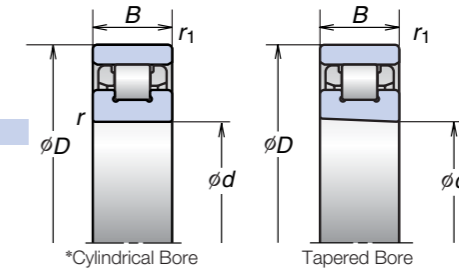

- For additional information: Page No.
- Dynamic equivalent load139
 - Static equivalent load146
 - Radial clearance169
 - Abutment and fillet dimensions ...186
 - Nozzle position192
 - Quantity of packed grease175

Bearing Numbers	Boundary Dimensions (mm)				Basic Load Ratings (kN)		Circumscribed circle diameter of roller (mm) (reference)	Mass (kg) (approx.)	Limiting Speeds (1) (min ⁻¹)	
	d	D	B	r	C _r (Dynamic)	C _{0r} (Static)			Grease	Oil
N1009RSZTPKR	45	75	16	1.0	16.0	14.7	67.5	0.243	16 000	23 000
N1009RXZTPKR	45	75	16	1.0	16.0	14.7	67.5	0.243	21 000	30 000
N1009RXHZTPKR	45	75	16	1.0	16.0	14.7	67.5	0.220	23 000	36 000
N1010RSZTPKR	50	80	16	1.0	17.1	16.5	72.5	0.262	15 000	21 000
N1010RXZTPKR	50	80	16	1.0	17.1	16.5	72.5	0.262	20 000	27 000
N1010RXHZTPKR	50	80	16	1.0	17.1	16.5	72.5	0.237	21 000	34 000
N1011RSZTPKR	55	90	18	1.1	20.7	19.7	81.0	0.344	13 000	19 000
N1011RXZTPKR	55	90	18	1.1	20.7	19.7	81.0	0.344	18 000	25 000
N1011RXHZTPKR	55	90	18	1.1	20.7	19.7	81.0	0.313	19 000	30 000
N1012RSZTPKR	60	95	18	1.1	22.2	22.1	86.1	0.411	12 000	18 000
N1012RXZTPKR	60	95	18	1.1	22.2	22.1	86.1	0.411	17 000	23 000
N1012RXHZTPKR	60	95	18	1.1	22.2	22.1	86.1	0.372	18 000	28 000
N1013RSZTPKR	65	100	18	1.1	23.6	24.5	91.0	0.484	11 000	17 000
N1013RXZTPKR	65	100	18	1.1	23.6	24.5	91.0	0.484	16 000	22 000
N1013RXHZTPKR	65	100	18	1.1	23.6	24.5	91.0	0.437	17 000	27 000
N1014RSZTPKR	70	110	20	1.1	27.8	28.5	100.0	0.604	10 000	16 000
N1014RXZTPKR	70	110	20	1.1	27.8	28.5	100.0	0.604	15 000	20 000
N1014RXHZTPKR	70	110	20	1.1	27.8	28.5	100.0	0.546	16 000	24 000
N1015RSZTPKR	75	115	20	1.1	29.6	31.5	105.0	0.623	9 900	15 000
N1015RXZTPKR	75	115	20	1.1	29.6	31.5	105.0	0.536	14 000	19 000
N1015RXHZTPKR	75	115	20	1.1	29.6	31.5	105.0	0.565	15 000	23 000
N1016RSZTPKR	80	125	22	1.1	36.5	39.5	113.0	0.859	9 200	14 000
N1016RXZTPKR	80	125	22	1.1	36.5	39.5	113.0	0.859	13 000	17 000
N1016RXHZTPKR	80	125	22	1.1	36.5	39.5	113.0	0.785	14 000	21 000
N1017RSZTPKR	85	130	22	1.1	38.5	43.0	118.0	0.870	8 800	13 000
N1017RXZTPKR	85	130	22	1.1	38.5	43.0	118.0	0.870	12 000	17 000
N1017RXHZTPKR	85	130	22	1.1	38.5	43.0	118.0	0.796	13 000	20 000

(1) For application of limiting speeds, please refer to Page 170.
*For the cylindrical bore type, eliminate the "KR" symbol and leave this symbol blank.

Cylindrical Roller Bearings
Low Heat Generation



High-Speed Angular Contact Thrust Ball Bearings

ROBUST Series



Double-Direction Angular Contact Thrust Ball Bearings

TAC Series

Angular Contact Thrust Ball Bearings

Angular Contact Thrust Ball Bearings100-105

Features

Numbering System

Bearing Tables

High-Speed Angular Contact Thrust Ball Bearings (ROBUST Series)

BAR10 Series

BTR10 Series

Double-Direction Angular Contact Thrust Ball Bearings (TAC Series)

TAC29D Series

TAC20D Series

Angular Contact Thrust Ball Bearings

Angular Contact Thrust Ball Bearings

Features

For the main spindles of machine tools, good high-speed performance and high rigidity are required for the ball bearings used in combination with double-row cylindrical roller bearings. For these applications, to allow selection appropriate for the characteristics of the machine, NSK provides three types of bearings.

All these bearings have special outer ring outside diameter tolerances (P4A Class and P2A Class) to provide clearance between the outer ring periphery and housing bore in order to avoid any load. NSK's ROBUST series high-speed angular contact thrust ball bearings are capable of high-speed operations while maintaining high rigidity. Ball diameter and number of balls are the same as TAC type bearings. BTR type bearings have a 40° contact angle, and BAR type bearings have a 30° contact angle. The result is superior high-speed performance that minimizes heat generation.

Interchangeability

Customers can easily replace their TAC20D series bearings with NSK's BAR type or BTR type bearings without having to change the shaft or housing of the machine tool spindle. Both types of bearings have unique width dimensions that accommodate a new spacer \square , which replaces the older one \square (see Fig. 3.1).

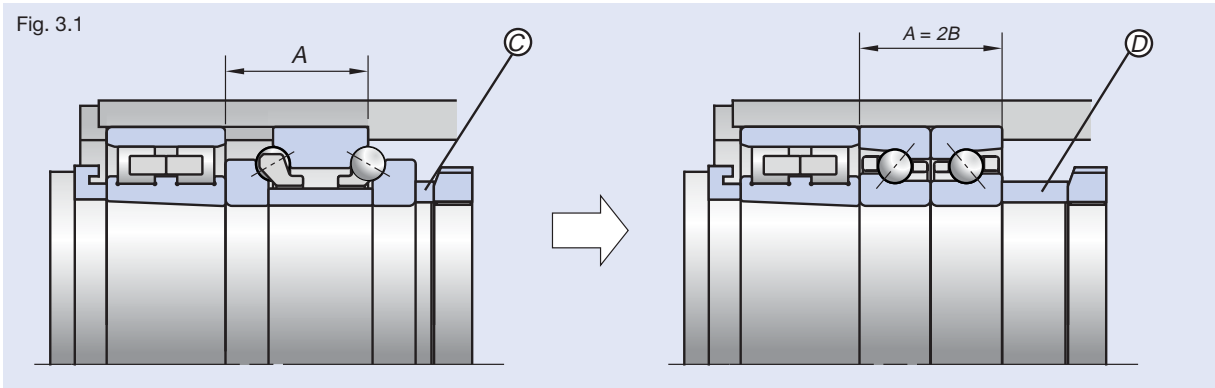

Contact Angle

For the differing contact angles, TAC type bearings rank highest in levels of rigidity, closely followed by BTR type bearings, with BAR type bearings coming in last. For temperature rise of the outer ring, however, this ranking is reversed with BAR type bearings having the highest tolerance, followed by BTR type bearings, and finally TAC type bearings with the least tolerance.

Be sure to select the product that will best meet the needs of your specific operating conditions.

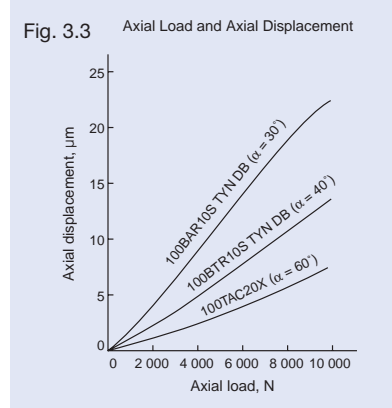
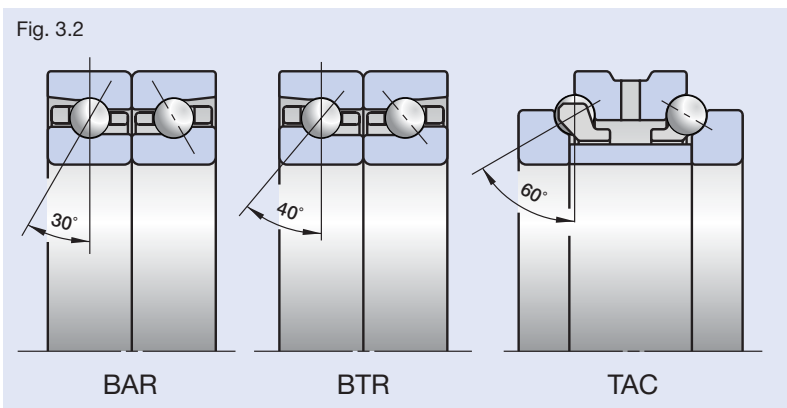

Numbering System of High-Speed Angular Contact Thrust Ball Bearings (ROBUST Series)

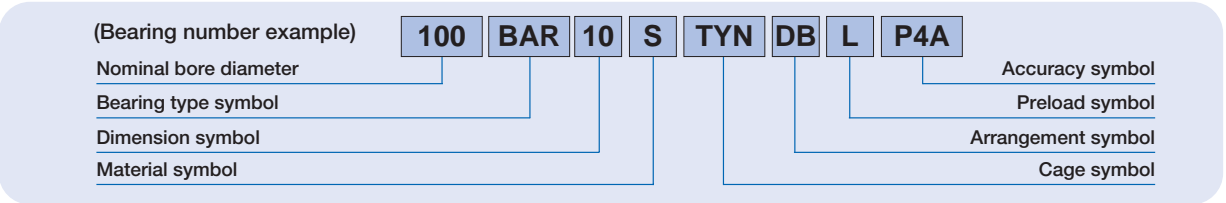

			Reference pages												
100	Nominal bore diameter	Bore diameter (mm)	102-104												
BAR	Bearing type	BAR: 30° contact angle BTR: 40° contact angle	28, 42-43, 100												
10	Dimension	10: 10 series (bore, outer diameter, and NSK-specific dimensions are available)	42-43, 100												
S	Material	<table border="1"> <thead> <tr> <th>Type</th> <th colspan="2">Material</th> </tr> <tr> <td></td> <th>Rings</th> <th>Rolling elements</th> </tr> </thead> <tbody> <tr> <td>S</td> <td>Bearing steel (SUJ2)</td> <td>Bearing steel (SUJ2)</td> </tr> <tr> <td>H</td> <td>Bearing steel (SUJ2)</td> <td>Ceramics (Si₃N₄)</td> </tr> </tbody> </table>	Type	Material			Rings	Rolling elements	S	Bearing steel (SUJ2)	Bearing steel (SUJ2)	H	Bearing steel (SUJ2)	Ceramics (Si ₃ N ₄)	14-17, 28
Type	Material														
	Rings	Rolling elements													
S	Bearing steel (SUJ2)	Bearing steel (SUJ2)													
H	Bearing steel (SUJ2)	Ceramics (Si ₃ N ₄)													
TYN	Cage	TYN: ball guided polyamide resin cage; limiting speed $d_m n = 1\,400\,000$; operational temperature limit = 120°C Bearing with TYN cage (10 series with a maximum bore diameter of 150 mm) (Leave this symbol blank for machined brass cages)	18-19												
DB	Arrangement	DB: Back-to-back arrangement	42-43, 148-151												
L	Preload	EL: extra light preload, L: light preload CP: special preload, CA: special axial clearance	42-43, 152-155, 166												
P4A	Accuracy	P2A: ISO Class 2 except outer diameter P4A: ISO Class 4 except outer diameter	182												

Numbering System of Double-Direction Angular Contact Thrust Ball Bearings (TAC Series)

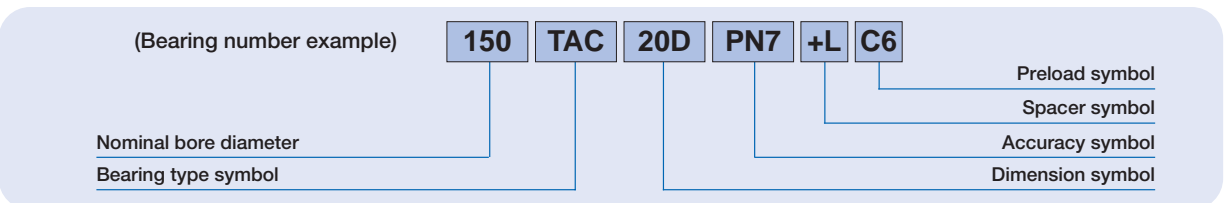

			Reference pages
150	Nominal bore diameter	Bore diameter (mm)	105
TAC	Bearing type	Angular contact thrust ball bearing; 60° contact angle	28, 42-43, 100
20D	Dimension	20D: combined with NN30 series 29D: combined with NN39 and NN49 series	42-43, 100
PN7	Accuracy	PN7: special precision accuracy	182
+L	Spacer	Inner ring spacer	-
C6	Preload	C6: standard preload for grease lubrication C7: standard preload for oil lubrication	42-43 152-155 167

3. ANGULAR CONTACT THRUST BALL BEARINGS

High-Speed Angular Contact Thrust Ball Bearings (ROBUST Series)

BAR10 Series BTR10 Series

Bore Diameter 50-105 mm

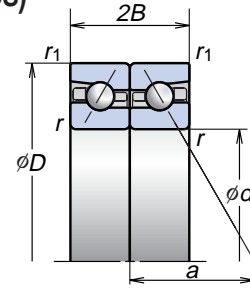

- For additional information: Page No.
- Dynamic equivalent load139
 - Static equivalent load146
 - Preload and rigidity152
 - Abutment and fillet dimensions186
 - Nozzle position192
 - Quantity of packed grease175

Bearing Numbers	Boundary Dimensions (mm)					Basic Load Ratings (kN)		Permissible Axial Load ⁽¹⁾ (kN)	Effective Load Center (mm) a	Mass (kg) (approx.)	Limiting Speeds ⁽²⁾ (min ⁻¹)	
	d	D	2B	r (min.)	r ₁ (min.)	C _a (Dynamic)	C _{0a} (Static)				Grease	Oil
50BAR10S	50	80	28.5	1.0	0.6	14.7	27.7	18.4	25.7	0.272	11 600	14 700
50BAR10H	50	80	28.5	1.0	0.6			12.6			13 100	16 200
50BTR10S	50	80	28.5	1.0	0.6	17.4	31.5	21.5	34.1	0.272	10 000	13 100
50BTR10H	50	80	28.5	1.0	0.6			15.5			11 600	14 700
55BAR10S	55	90	33.0	1.1	0.6	18.2	35.0	23.4	28.9	0.412	10 400	13 200
55BAR10H	55	90	33.0	1.1	0.6			16.0			11 800	14 500
55BTR10S	55	90	33.0	1.1	0.6	21.6	40.0	26.4	38.3	0.412	9 000	11 800
55BTR10H	55	90	33.0	1.1	0.6			19.7			10 400	13 200
60BAR10S	60	95	33.0	1.1	0.6	18.9	38.0	25.5	30.4	0.420	9 700	12 300
60BAR10H	60	95	33.0	1.1	0.6			17.5			11 000	13 600
60BTR10S	60	95	33.0	1.1	0.6	22.4	43.5	25.8	40.4	0.420	8 400	11 000
60BTR10H	60	95	33.0	1.1	0.6			21.5			9 700	12 300
65BAR10S	65	100	33.0	1.1	0.6	19.5	41.5	27.7	31.8	0.447	9 100	11 600
65BAR10H	65	100	33.0	1.1	0.6			19.0			10 400	12 800
65BTR10S	65	100	33.0	1.1	0.6	23.1	47.0	27.3	42.5	0.447	7 900	10 400
65BTR10H	65	100	33.0	1.1	0.6			23.3			9 100	11 600
70BAR10S	70	110	36.0	1.1	0.6	26.9	55.0	37.5	34.7	0.601	8 400	10 600
70BAR10H	70	110	36.0	1.1	0.6			25.5			9 500	11 700
70BTR10S	70	110	36.0	1.1	0.6	32.0	63.0	35.0	46.3	0.601	7 300	9 500
70BTR10H	70	110	36.0	1.1	0.6			31.5			8 400	10 600
75BAR10S	75	115	36.0	1.1	0.6	27.3	58.0	39.0	36.1	0.634	7 900	10 000
75BAR10H	75	115	36.0	1.1	0.6			26.7			9 000	11 100
75BTR10S	75	115	36.0	1.1	0.6	32.5	65.5	36.5	48.4	0.634	6 900	9 000
75BTR10H	75	115	36.0	1.1	0.6			33.0			7 900	10 000

⁽¹⁾ For permissible axial load, please refer to Page 147.

⁽²⁾ For application of limiting speeds, please refer to Page 170.

Limiting speeds listed on this page are based on a back-to-back arrangement (DB) with extra light preload (EL). Adjust the limiting speed to 85% of the figure shown when a light preload (L) has been selected.

Note: Bearing type BAR10: nominal contact angle 30°
Bearing type BTR10: nominal contact angle 40°

BAR10 Series (continued) BTR10 Series

Bearing Numbers	Boundary Dimensions (mm)					Basic Load Ratings (kN)		Permissible Axial Load ⁽¹⁾ (kN)	Effective Load Center (mm) a	Mass (kg) (approx.)	Limiting Speeds ⁽²⁾ (min ⁻¹)	
	d	D	2B	r (min.)	r ₁ (min.)	C _a (Dynamic)	C _{0a} (Static)				Grease	Oil
80BAR10S	80	125	40.5	1.1	0.6	32.0	68.5	46.5	39.4	0.875	7 400	9 300
80BAR10H	80	125	40.5	1.1	0.6			32.0			8 300	10 300
80BTR10S	80	125	40.5	1.1	0.6	38.0	78.0	43.0	52.7	0.875	6 400	8 300
80BTR10H	80	125	40.5	1.1	0.6			39.0			7 400	9 300
85BAR10S	85	130	40.5	1.1	0.6	32.5	71.5	48.5	41.1	0.971	7 000	8 900
85BAR10H	85	130	40.5	1.1	0.6			33.0			8 000	9 800
85BTR10S	85	130	40.5	1.1	0.6	38.5	81.5	50.5	55.2	0.971	6 100	8 000
85BTR10H	85	130	40.5	1.1	0.6			41.0			7 000	8 900
90BAR10S	90	140	45	1.5	1.0	42.5	92.5	62.5	44.4	1.198	6 600	8 300
90BAR10H	90	140	45	1.5	1.0			43.0			7 400	9 200
90BTR10S	90	140	45	1.5	1.0	50.0	105	58.0	59.5	1.198	5 700	7 400
90BTR10H	90	140	45	1.5	1.0			52.5			6 600	8 300
95BAR10S	95	145	45	1.5	1.0	43.0	96.5	65.0	45.5	1.320	6 300	8 000
95BAR10H	95	145	45	1.5	1.0			44.5			7 100	8 800
95BTR10S	95	145	45	1.5	1.0	51.0	110	69.0	61.0	1.320	5 500	7 100
95BTR10H	95	145	45	1.5	1.0			55.0			6 300	8 000
100BAR10S	100	150	45	1.5	1.0	43.5	100	68.0	47.3	1.399	6 000	7 600
100BAR10H	100	150	45	1.5	1.0			46.5			6 800	8 400
100BTR10S	100	150	45	1.5	1.0	51.5	114	66.5	63.7	1.399	5 200	6 800
100BTR10H	100	150	45	1.5	1.0			57.0			6 000	7 600
105BAR10S	105	160	49.5	2.0	1.0	49.5	115	78.0	50.6	1.740	5 700	7 200
105BAR10H	105	160	49.5	2.0	1.0			53.5			6 500	8 000
105BTR10S	105	160	49.5	2.0	1.0	58.5	131	84.0	68.0	1.740	5 000	6 500
105BTR10H	105	160	49.5	2.0	1.0			65.5			5 700	7 200

⁽¹⁾ For permissible axial load, please refer to Page 147.

⁽²⁾ For application of limiting speeds, please refer to Page 170.

Limiting speeds listed on this page are based on a back-to-back arrangement (DB) with extra light preload (EL). Adjust the limiting speed to 85% of the figure shown when a light preload (L) has been selected.

Note: Bearing type BAR10: nominal contact angle 30°
Bearing type BTR10: nominal contact angle 40°

3. ANGULAR CONTACT THRUST BALL BEARINGS

High-Speed Angular Contact Thrust Ball Bearings (ROBUST Series)

BAR10 Series
BTR10 Series

Bore Diameter 110-200 mm

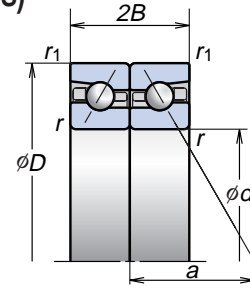

Bearing Numbers	Boundary Dimensions (mm)					Basic Load Ratings (kN)		Permissible Axial Load ⁽¹⁾ (kN)	Effective Load Center (mm) a	Mass (kg) (approx.)	Limiting Speeds ⁽²⁾ (min ⁻¹)	
	d	D	2B	r (min.)	r ₁ (min.)	C _a (Dynamic)	C _{0a} (Static)				Grease	Oil
110BAR10S	110	170	54.0	2.0	1.0	55.5	131	89.0	53.9	2.11	5 400	6 800
110BAR10H	110	170	54.0	2.0	1.0			60.5			7 500	
110BTR10S	110	170	54.0	2.0	1.0	66.0	148	82.5	72.2	2.11	4 700	6 100
110BTR10H	110	170	54.0	2.0	1.0			74.5			6 800	
120BAR10S	120	180	54.0	2.0	1.0	57.0	141	96.0	56.8	2.262	5 000	6 400
120BAR10H	120	180	54.0	2.0	1.0			65.5			7 000	
120BTR10S	120	180	54.0	2.0	1.0	68.0	160	88.5	76.4	2.262	4 400	5 700
120BTR10H	120	180	54.0	2.0	1.0			80.5			6 400	
130BAR10S	130	200	63.0	2.0	1.0	72.5	172	117	63.4	3.362	4 600	5 800
130BAR10H	130	200	63.0	2.0	1.0			79.5			6 400	
130BTR10S	130	200	63.0	2.0	1.0	86.0	195	106	85.0	3.362	4 000	5 200
130BTR10H	130	200	63.0	2.0	1.0			98.0			5 800	
140BAR10S	140	210	63.0	2.0	1.0	78.5	200	135	66.2	3.558	4 300	5 500
140BTR10S	140	210	63.0	2.0	1.0	93.0	227	84.0	89.1	3.558	3 800	4 900
150BAR10S	150	225	67.5	2.1	1.1	92.5	234	160	71	4.354	4 000	5 100
150BTR10S	150	225	67.5	2.1	1.1	110	267	104	95.5	4.354	3 500	4 600
160BAR10S	160	240	72.0	2.1	1.1	98.5	250	175	75.7	5.64	3 800	4 800
160BTR10S	160	240	72.0	2.1	1.1	117	284	184	101.9	5.64	3 300	4 300
170BAR10S	170	260	81.0	2.1	1.1	115	295	207	82.3	7.90	3 500	4 500
170BTR10S	170	260	81.0	2.1	1.1	136	335	220	110.5	7.90	3 100	4 000
180BAR10S	180	280	90.0	2.1	1.1	151	385	262	88.8	10.2	3 300	4 200
180BTR10S	180	280	90.0	2.1	1.1	179	440	255	118.9	10.2	2 900	3 700
190BAR10S	190	290	90.0	2.1	1.1	151	390	273	91.8	10.7	3 200	4 000
190BTR10S	190	290	90.0	2.1	1.1	179	445	281	123.2	10.7	2 800	3 600
200BAR10S	200	310	99.0	2.1	1.1	169	444	300	98.3	13.8	3 000	3 800
200BTR10S	200	310	99.0	2.1	1.1	201	505	310	131.7	13.8	2 600	3 400

⁽¹⁾ For permissible axial load, please refer to Page 147.
⁽²⁾ For application of limiting speeds, please refer to Page 170.
 Limiting speeds listed on this page are based on a back-to-back arrangement (DB) with extra light preload (EL).
 Adjust the limiting speed to 85% of the figure shown when a light preload (L) has been selected.
Note: Bearing type BAR10: nominal contact angle 30°
 Bearing type BTR10: nominal contact angle 40°

Double-Direction Angular Contact Thrust Ball Bearings (TAC Series)

TAC29D Series
TAC20D Series

Bore Diameter 140-280 mm

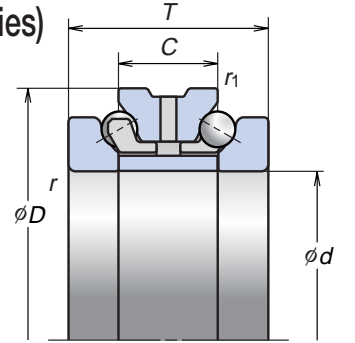

Bearing Numbers	Boundary Dimensions (mm)						Basic Load Ratings (kN)		Mass (kg) (approx.)	Limiting Speeds ⁽¹⁾ (min ⁻¹)	
	d	D	T	C	r (min.)	r ₁ (min.)	C _a (Dynamic)	C _{0a} (Static)		Grease	Oil
140TAC20D+L	140	210	84	42	2.0	1.0	145	525	8.750	2 600	2 900
150TAC29D+L	150	210	72	36	2.0	1.0	116	465	6.600	2 500	2 800
150TAC20D+L	150	225	90	45	2.1	1.1	172	620	10.700	2 400	2 700
160TAC29D+L	160	220	72	36	2.0	1.0	118	490	7.000	2 400	2 700
160TAC20D+L	160	240	96	48	2.1	1.1	185	680	13.000	2 300	2 500
170TAC29D+L	170	230	72	36	2.0	1.0	120	520	7.350	2 300	2 500
170TAC20D+L	170	260	108	54	2.1	1.1	218	810	17.700	2 100	2 400
180TAC29D+L	180	250	84	42	2.0	1.0	158	655	10.700	2 100	2 400
180TAC20D+L	180	280	120	60	2.1	1.1	281	1 020	23.400	2 000	2 200
190TAC29D+L	190	260	84	42	2.0	1.0	161	695	11.200	2 000	2 300
190TAC20D+L	190	290	120	60	2.1	1.1	285	1 060	24.400	1 900	2 100
200TAC29D+L	200	280	96	48	2.1	1.1	204	855	15.700	1 900	2 100
200TAC20D+L	200	310	132	66	2.1	1.1	315	1 180	31.500	1 800	2 000
220TAC29D+L	220	300	96	48	2.1	1.1	210	930	17.000	1 800	2 000
240TAC29D+L	240	320	96	48	2.1	1.1	213	980	18.300	1 700	1 800
260TAC29D+L	260	360	120	60	2.1	1.1	315	1 390	31.500	1 500	1 700
280TAC29D+L	280	380	120	60	2.1	1.1	320	1 470	33.500	1 400	1 600

⁽¹⁾ Limiting speeds listed on this page are based on recommended standard preload (C6 & C7)
Note: Bearing type TAC29D: nominal contact angle 60°
 Bearing type TAC20D: nominal contact angle 60°



Machine Tool Applications

TAC B Series



Electric Injection Molding Machines Applications

TAC02 and 03 Series



Machine Tool Applications

Ball Screw Support Units

Ball Screw Support Bearings

Angular Contact Thrust Ball Bearings for Ball Screw Support.....P108-113

Features

Numbering System

Bearing Tables

Machine Tool Applications

TAC B Series

Electric Injection Molding Machine Applications

TAC02 and 03 Series

Units for Ball Screw SupportP114-115

Features

Numbering System

Support Units Tables

B/S Support

Ball Screw Support Bearings

Angular Contact Thrust Ball Bearings for Ball Screw Support

Features

High precision angular contact thrust ball bearings to support precision ball screws, have better performance than earlier combinations of angular contact ball bearings or combinations using thrust bearings. They are especially suitable for high precision machine-tool feeding mechanisms and similar applications.

TAC B Series (Machine Tool Applications)

The axial rigidity is high because of a large number of balls and a contact angle of 60°. Compared with tapered roller bearings of cylindrical roller bearings, this type has lower starting torque; so smoother rotation is possible with less driving force.

TAC B series bearings incorporate NSK's recently developed molded polyamide resin cage. In addition, using extra-pure (EP) steel for the inner and outer rings has further enhanced service life. Our EP steel is manufactured by controlling the amount of harmful oxide inclusions, which eliminates large size inclusions and enjoys higher purity than vacuum arc remelted (VAR) steel.

This series with "DG" seal, low torque contact seal, with "WPH" grease, an waterproof grease, increase the reliability and provide for easy handling.

TAC02 and 03 Series (Electric Injection Molding Machines)

TAC02 and 03 series are angular contact ball bearings that provide support for large size ball screws operating under a heavy load from the driving mechanism of electric injection molding machines. Low torque is achieved by optimum design of the ball bearings. Users can significantly reduce bearing torque by replacing their roller bearings with these series.

TAC B and TAC02, 03 Differences

Electric injection molding machines produce a heavier load on ball screw support bearings than that of machine tools. TAC02 and 03 bearings are designed to operate under such heavy load conditions. Conversely, TAC B bearings are designed for increased permissible load by increasing the number of balls and bearing width.

Fig. 4.1

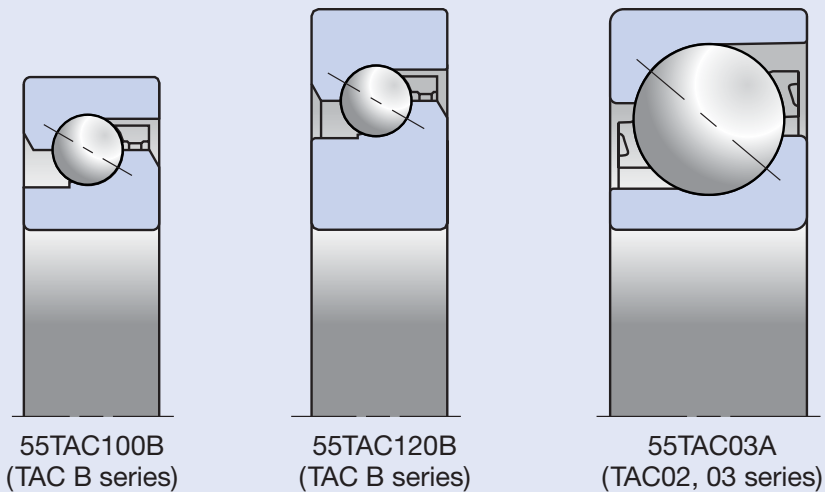

Numbering System of Angular Contact Thrust Ball Bearings for Ball Screw Support (Machine Tool Applications)

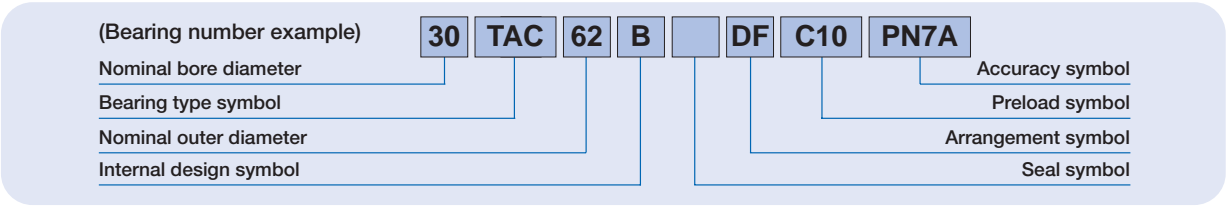

			Reference pages
30	Nominal bore diameter	Bore diameter (mm)	110-111
TAC	Bearing type	Angular contact thrust ball bearing; 60° contact angle	30, 108
62	Nominal outer diameter	Outer diameter (mm)	110-111
B	Internal design		-
	Seal	No symbol: open type DDG: contact rubber seal (*)	30
DF	Arrangement	SU: universal arrangement (single row) DU: universal arrangement (double row) DB: Back-to-back arrangement DF: Face-to-face arrangement DT: tandem arrangement DBD, DFD, DTD: triplex set arrangement DBB, DFF, DBT, DFT, DTT: quadruplex set arrangement	148-151
C10	Preload	C10: standard preload C9: light preload (low torque specification)	152-155, 168
PN7A	Accuracy	PN7A: standard accuracy (Equivalent to ISO Class 4) PN7B: special accuracy (Bore diameter and outside diameter are exclusive to NSK. Equivalent to ISO Class 4. For SU arrangement only.)	183

(*) Sealed angular contact ball bearings for ball screw support are standardized for SU arrangement and PN7B accuracy.

Numbering System of Angular Contact Thrust Ball Bearings for Ball Screw Support (Electric Injection Molding Machines)

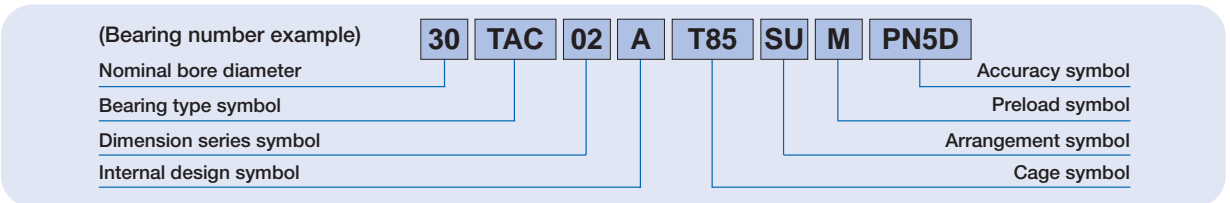

			Reference pages
30	Nominal bore diameter	Bore diameter (mm)	112-113
TAC	Bearing type	Angular contact thrust ball bearing; 60° contact angle	31, 108
02	Dimension series	02: 02 series, 03: 03 series	108
A	Internal design		-
T85	Cage	T85: polyamide resin cage M: machined brass cage	18-19
SU	Arrangement	SU: universal arrangement (single row)	148-151
M	Preload	M: standard preload	152-155, 168
PN5D	Accuracy	PN5D: standard accuracy (Equivalent to ISO Class 5)	183

4. BALL SCREW SUPPORT BEARINGS

For Machine Tool Applications

TAC B Series

Bore Diameter 15-60 mm

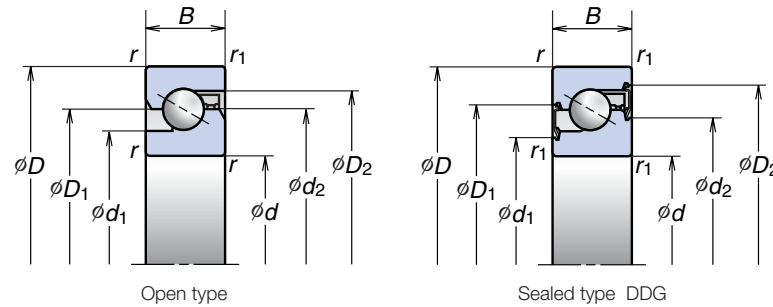

(Open type)

Bearing Numbers	Boundary Dimensions (mm)					Reference Dimensions (mm)				Recommended Grease Quantities (cc)	Limiting Speeds (1) (min ⁻¹)	
	d	D	B	r (min.)	r ₁ (min.)	d ₁	d ₂	D ₁	D ₂		Grease	Oil
15 TAC 47B	15	47	15	1.0	0.6	27.2	34	34	39.6	2.2	6 000	8 000
17 TAC 47B	17	47	15	1.0	0.6	27.2	34	34	39.6	2.2	6 000	8 000
20 TAC 47B	20	47	15	1.0	0.6	27.2	34	34	39.6	2.2	6 000	8 000
25 TAC 62B	25	62	15	1.0	0.6	37	45	45	50.7	3.0	4 500	6 000
30 TAC 62B	30	62	15	1.0	0.6	39.5	47	47	53.2	3.2	4 300	5 600
35 TAC 72B	35	72	15	1.0	0.6	47	55	55	60.7	3.8	3 600	5 000
40 TAC 72B	40	72	15	1.0	0.6	49	57	57	62.7	3.9	3 600	4 800
40 TAC 90B	40	90	20	1.0	0.6	57	68	68	77.2	8.8	3 000	4 000
45 TAC 75B	45	75	15	1.0	0.6	54	62	62	67.7	4.2	3 200	4 300
45 TAC 100B	45	100	20	1.0	0.6	64	75	75	84.2	9.7	2 600	3 600
50 TAC 100B	50	100	20	1.0	0.6	67.5	79	79	87.7	10.2	2 600	3 400
55 TAC 100B	55	100	20	1.0	0.6	67.5	79	79	87.7	10.2	2 600	3 400
55 TAC 120B	55	120	20	1.0	0.6	82	93	93	102.2	12	2 200	3 000
60 TAC 120B	60	120	20	1.0	0.6	82	93	93	102.2	12	2 200	3 000

(Sealed type)

Bearing Numbers	Boundary Dimensions (mm)					Reference Dimensions (mm)				Limiting Speeds (1) (min ⁻¹)
	d	D	B	r (min.)	r ₁ (min.)	d ₁	d ₂	D ₁	D ₂	Grease
15 TAC 47B DDG	15	47	15	1.0	0.6	25.1	30.8	36	41.8	6 000
17 TAC 47B DDG	17	47	15	1.0	0.6	25.1	30.8	36	41.8	6 000
20 TAC 47B DDG	20	47	15	1.0	0.6	25.1	30.8	36	41.8	6 000
25 TAC 62B DDG	25	62	15	1.0	0.6	34.3	40.5	46.5	52.9	4 500
30 TAC 62B DDG	30	62	15	1.0	0.6	36.8	43	49	55.4	4 300
35 TAC 72B DDG	35	72	15	1.0	0.6	44.3	50.5	56.5	62.9	3 600
40 TAC 72B DDG	40	72	15	1.0	0.6	46.3	52.5	58.5	64.9	3 600
40 TAC 90B DDG	40	90	20	1.0	0.6	54	64	70	79.4	3 000
45 TAC 100B DDG	45	100	20	1.0	0.6	61	71	77	86.4	2 600

(1) Limiting speeds are based on C10 preload. In case of C9 preload, the figures become 1.3 times of the figures listed above. Also, the figures are free of the influence arrangement type.

Note: Bearing type TAC B: nominal contact angle 60°

Basic Dynamic Load Rating C _a			Limiting Axial Load (2)			Mass (kg) (approx.)
Single Row Load DF, DB (kN)	Double Row Load DT, DFD, DBD, DFF, DBB (kN)	Triple Row Load DTD, DFT, DBT (kN)	Single Row Load DF, DB (kN)	Double Row Load DT, DFD, DBD, DFF, DBB (kN)	Triple Row Load DTD, DFT, DBT (kN)	
21.9	35.5	47.5	26.6	53.0	79.5	0.144
21.9	35.5	47.5	26.6	53.0	79.5	0.144
21.9	35.5	47.5	26.6	53.0	79.5	0.135
28.5	46.5	61.5	40.5	81.5	122	0.252
29.2	47.5	63.0	43.0	86.0	129	0.224
31.0	50.5	67.0	50.0	100	150	0.310
31.5	51.5	68.5	52.0	104	157	0.275
59.0	95.5	127	89.5	179	269	0.674
33.0	53.5	71.0	57.0	114	170	0.270
61.5	100	133	99.0	198	298	0.842
63.0	102	136	104	208	310	0.778
63.0	102	136	104	208	310	0.714
67.5	109	145	123	246	370	1.230
67.5	109	145	123	246	370	1.160

Basic Dynamic Load Rating C _a			Limiting Axial Load (2)			Mass (kg) (approx.)
Single Row Load DF, DB (kN)	Double Row Load DT, DFD, DBD, DFF, DBB (kN)	Triple Row Load DTD, DFT, DBT (kN)	Single Row Load DF, DB (kN)	Double Row Load DT, DFD, DBD, DFF, DBB (kN)	Triple Row Load DTD, DFT, DBT (kN)	
21.9	35.5	47.5	26.6	53.0	79.5	0.144
21.9	35.5	47.5	26.6	53.0	79.5	0.144
21.9	35.5	47.5	26.6	53.0	79.5	0.135
28.5	46.5	61.5	40.5	81.5	122	0.252
29.2	47.5	63.0	43.0	86.0	129	0.224
31.0	50.5	67.0	50.0	100	150	0.310
31.5	51.5	68.5	52.0	104	157	0.275
59.0	95.5	127	89.5	179	269	0.674
61.5	100	133	99.0	198	298	0.842

(2) Permissible axial load equals 0.7 times of limiting axial load.

4. BALL SCREW SUPPORT BEARINGS

For Electric Injection Molding Machines

TAC02 and 03 Series

Bore Diameter 15-120 mm

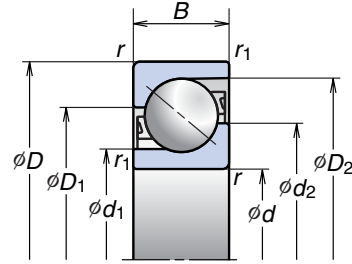

Bearing Numbers	Boundary Dimensions (mm)					Reference Dimensions (mm)				Recommended Grease Quantities (cc)	Contact angle (Degree)	Limiting Speeds (min ⁻¹)
	d	D	B	r (min.)	r ₁ (min.)	d ₁	d ₂	D ₁	D ₂			
15TAC02AT85	15	35	11	0.6	0.3	19.5	23.5	26.5	31.9	0.98	50	12 000
25TAC02AT85	25	52	15	1.0	0.6	30.5	36.6	40.4	47.4	3	50	7 700
TAC35-2T85	35	90	23	1.5	1.0	49.7	61.4	68.6	81.9	15	50	4 600
40TAC03AT85	40	90	23	1.5	1.0	49.7	61.4	68.6	81.9	15	50	4 600
45TAC03AT85	45	100	25	1.5	1.0	55.8	68.6	76.4	91.0	19	50	4 100
TAC45-2T85	45	110	27	2.0	1.0	60.3	75.6	84.5	100.9	27	50	3 700
50TAC03AT85	50	110	27	2.0	1.0	60.3	75.6	84.5	100.9	27	50	3 700
55TAC03AT85	55	120	29	2.0	1.0	67.1	82.7	92.3	110.1	32	50	3 400
60TAC03AT85	60	130	31	2.1	1.1	72.1	89.8	100.2	119.4	54	50	3 100
80TAC03AM	80	170	39	2.1	1.1	94.0	118.5	131.5	152.5	82	50	2 400
100TAC03CMC	100	215	47	3.0	1.1	122.5	156.9	158.1	188.1	120	55	1 900
120TAC03CMC	120	260	55	3.0	1.1	153.0	189.3	190.7	223.5	170	55	1 500

Dynamic Axial Load Rating C _a			Limiting Axial Load (¹)		
Single Row Load DF, DB (kN)	Double Row Load DT, DFD, DBD, DFF, DBB (kN)	Triple Row Load DTD, DFT, DBT (kN)	Single Row Load DF, DB (kN)	Double Row Load DT, DFD, DBD, DFF, DBB (kN)	Triple Row Load DTD, DFT, DBT (kN)
18.8	30.5	40.5	11.5	22.9	34.5
33.5	54.5	72.0	22.7	45.5	68.0
102	166	220	75.5	151	226
102	166	220	75.5	151	226
120	195	259	91.5	183	274
150	243	325	116	232	350
150	243	325	116	232	350
171	278	370	133	266	400
196	320	425	152	305	455
274	445	590	238	475	715
365	595	795	231	460	690
430	700	930	295	590	885

(¹) Permissible axial load equals 0.7 times of limiting axial load.

Units for Ball Screw Support



The support unit for heavy-load machine tools employs a high precision, high rigidity Angular contact thrust ball bearing for Ball Screw Support (TAC Series), which is structured to function optimally as a support bearing for a ball screw. Three types of arrangements are available, as described in the figure below:

Features

- The dust-resistant design allows a user to easily design support side of ball screw.
- Since a preload-controlled bearing is incorporated into the support unit, the process of mounting a bearing can be omitted.

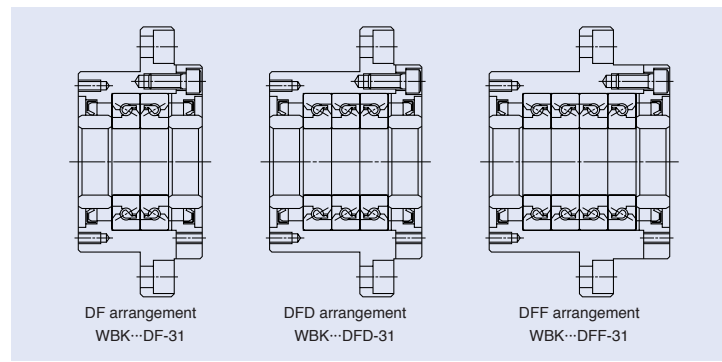

Numbering system of support units

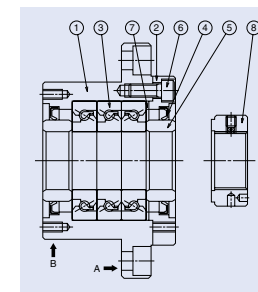
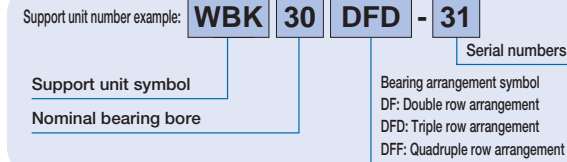

Components of support unit

Part No.	Name of Part	Quantities
①	Housing	1
②	Retaining cover	1
③	Angular contact thrust ball bearings for Ball Screw Support	1 set
④	Dust seal	2
⑤	Collar	2
⑥	Preload securing bolt	6 or 8
⑦	Shim	1 set
⑧	Locknut	1

1. Use datum faces A and B to mount the support unit to a machine base.
2. Do not try to disassemble the NSK Support Unit because its preload is adjusted with high precision and the components of numbers ①, ②, ③, ④, ⑥ and ⑦ are integrated into a single piece.
3. Grease is packed in the bearing.
4. Locknut ⑧ is designed specifically for ball screws with its perpendicularities controlled against the triangular thread of the screw. To prevent loosening, tighten the locknut using turn-preventive small screws. The locknut is also available separately. For Angular contact thrust ball bearings for Ball Screw Support, please refer to Page 110.

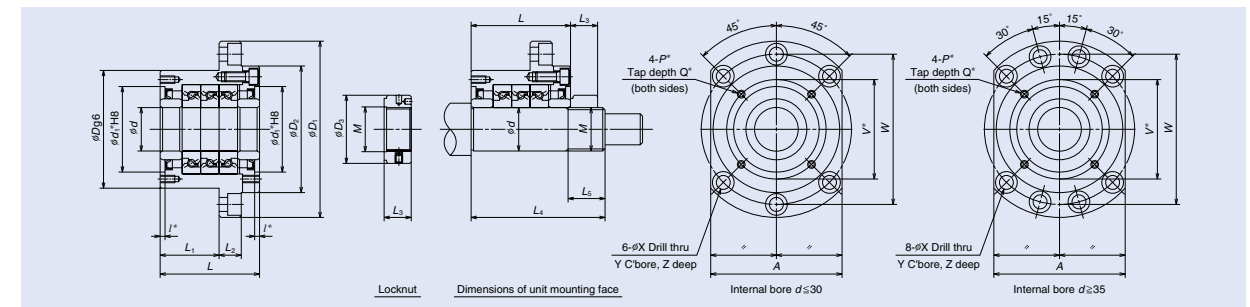

Support Unit Numbers	Support Unit Parts																
	d	D	D_1	D_2	L	L_1	L_2	A	W	X	Y	Z	d_1^*	I^*	V^*	P^*	Q^*
WBK17DF-31	17	70	106	72	60	32	15	80	88	9	14	8.5	45	3	58	M5	10
WBK20DF-31	20	70	106	72	60	32	15	80	88	9	14	8.5	45	3	58	M5	10
WBK25DF-31	25	85	130	90	66	33	18	100	110	11	17.5	11	57	4	70	M6	12
WBK25DFD-31					81	48											
WBK30DF-31	30	85	130	90	66	33	18	100	110	11	17.5	11	57	4	70	M6	12
WBK30DFD-31					81	48											
WBK35DF-31	35	95	142	102	66	33	18	106	121	11	17.5	11	69	4	80	M6	12
WBK35DFD-31					81	48											
WBK35DFF-31					96	48											
WBK40DF-31	40	95	142	102	66	33	18	106	121	11	17.5	11	69	4	80	M6	12
WBK40DFD-31					81	48											
WBK40DFF-31					96	48											

Remarks: 1. Rigidity: Rigidity values in the table show theoretical values calculated from elastic displacement between grooves and steel balls.
 2. Starting torque: Starting torque in the table shows starting torque necessary for a preloaded bearing, not including seal torque.
 3. Tolerance of Shaft Outer Diameter at the bearing seat for unit: h5 Class is recommended for the Shaft Outer Diameter at the bearing seat for unit.

Basic dynamic load rating	Limiting Axial Load	Preload	Axial Rigidity	Starting torque	Locknut			Bearing seat for unit		
					M	D_3	L_3	d	L_4	L_5
C_a (N)	(N)	(N)	(N/ μ m)	(N·cm)						
21 900	26 600	2 150	750	14.0	M17· 1	37	18	17	81	23
21 900	26 600	2 150	750	14.0	M25· 1.5	45	20	25	89	26
28 500	40 500	3 150	1 000	23.0					104	
46 500	81 500	4 300	1 470	31.0	M30· 1.5	50	20	30	89	26
29 200	43 000	3 350	1 030	24.0					104	
47 500	86 000	4 500	1 520	33.0					92	
31 000	50 000	3 800	1 180	28.0	M35· 1.5	55	22	35	107	30
50 500	100 000	5 200	1 710	37.0					122	
50 500	100 000	7 650	2 350	55.0					92	
31 500	52 000	3 900	1 230	28.0	M40· 1.5	60	22	40	107	30
51 500	104 000	5 300	1 810	38.0					122	
51 500	104 000	7 800	2 400	57.0					92	

Remarks: 4. Dimensions marked with * The spigot and screw parts marked with * are used for mounting a seal unit for the NSK standard hollow ball screw shaft as well as for mounting a dust cover and damper.
 5. Because grease is packed in the bearing, it can be used immediately as is.



Precision Deep Groove Ball Bearings

Polyamide Resin Cage

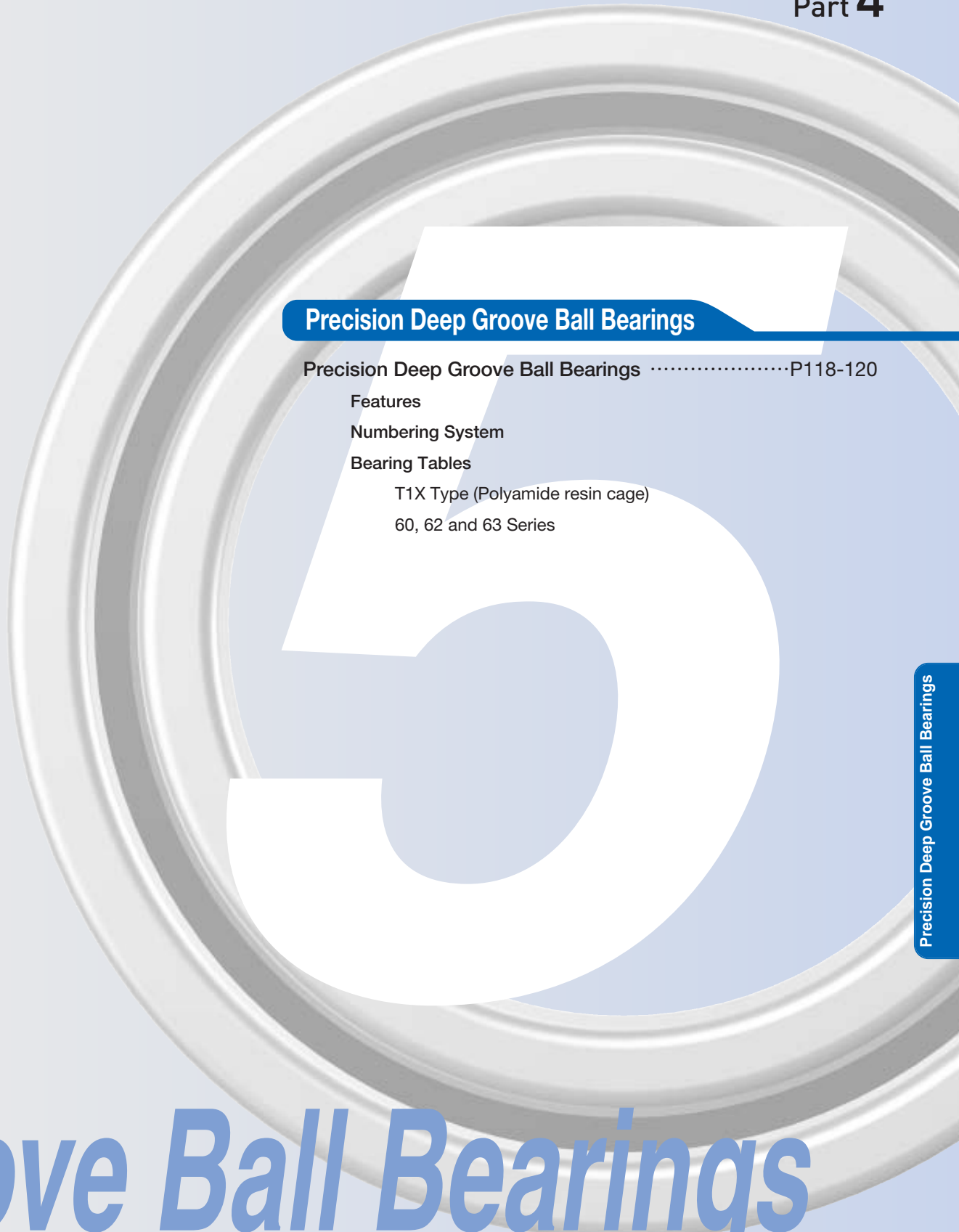

Precision Deep Groove Ball Bearings

Precision Deep Groove Ball BearingsP118-120

Features

Numbering System

Bearing Tables

T1X Type (Polyamide resin cage)

60, 62 and 63 Series

Precision Deep Groove Ball Bearings

Precision Deep Groove Ball Bearings

Features

- Capable of bearing not only radial loads but also axial loads in both directions.
- Frictional torque is small, thus suitable for operations requiring high speed, low noise, and low vibrations.
- Three types are available: open type; shielded type (steel shield); and sealed type (rubber seal).

Dimension series

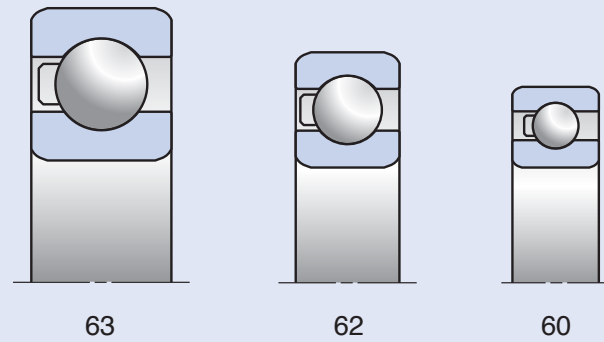

Structure

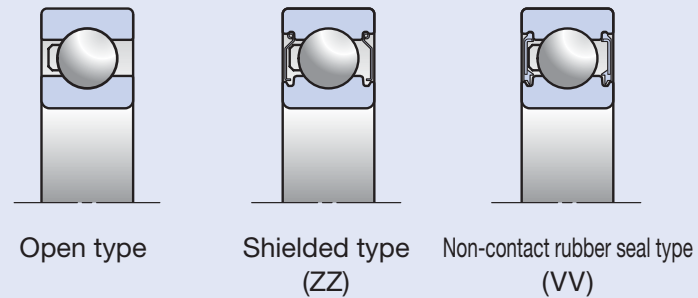

Cages

- T1X** Ball guided polyamide resin cage: provides superior wear resistance for general purpose motors.
- TYA** Ball guided polyamide resin cage: incorporates the same design concepts of angular contact ball bearings for high-speed motors.

Numbering System of Precision Deep Groove Ball Bearings

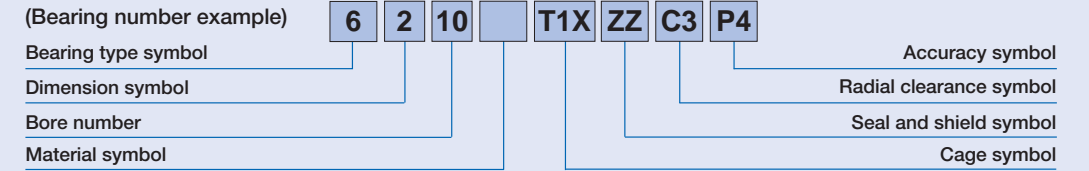

Symbol	Meaning	Reference pages
6	Bearing type 6: single-row deep groove ball bearing	118
2	Dimension 0: 10 series, 2: 02 series, 3: 03 series	118
10	Bore number Less than 03 bearing bore 00: 10 mm, 01: 12 mm, 02: 15 mm, 03: 17 mm More than 04 bearing bore: Bore number x 5 (mm)	120
	Material No symbol: bearing steel (SUJ2) SN24: ceramic ball (Si ₃ N ₄)	14-17
T1X	Cage T1X: ball guided polyamide resin cage TYA: high speed, ball guided polyamide resin cage	118
ZZ	Seal and shield No symbol: open type ZZ: steel shield VV: non-contact rubber seal	118
C3	Radial clearance No symbol: normal clearance C3: larger than normal clearance CM: special clearance for electric motor CG: special radial clearance	-
P4	Accuracy P2: ISO Class 2 P4: ISO Class 4 P5: ISO Class 5	176-179

5. PRECISION DEEP GROOVE BALL BEARINGS

T1X Type (Polyamide Resin Cage)

60, 62 and 63 Series

Bore Diameter 10-50 mm

Open type	Shield type	Seal type
6000	ZZ	VV

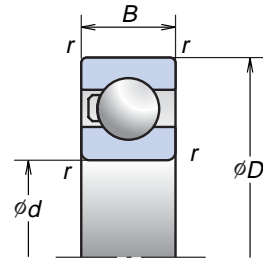

Bearing ⁽¹⁾ Numbers	Shield type	Seal type	Boundary Dimensions (mm)				Basic Load Ratings (kN)		Limiting Speeds ⁽²⁾ (min ⁻¹)
			d	D	B	r	C _r (Dynamic)	C _{0r} (Static)	
6000T1X	ZZ	VV	10	26	8	0.3	4.55	1.87	38 900
6200T1X	ZZ	VV	10	30	9	0.6	5.10	2.39	35 000
6001T1X	ZZ	VV	12	28	8	0.3	5.10	2.37	35 000
6201T1X	ZZ	VV	12	32	10	0.6	6.80	3.05	31 900
6301T1X	ZZ	VV	12	37	12	1.0	9.70	4.20	28 600
6002T1X	ZZ	VV	15	32	9	0.3	5.60	2.83	29 800
6202T1X	ZZ	VV	15	35	11	0.6	7.65	3.75	28 000
6302T1X	ZZ	VV	15	42	13	1.0	11.4	5.45	24 600
6003T1X	ZZ	VV	17	35	10	0.3	6.00	3.25	27 000
6203T1X	ZZ	VV	17	40	12	0.6	9.55	4.80	24 600
6303T1X	ZZ	VV	17	47	14	1.0	13.6	6.65	21 900
6004T1X	ZZ	VV	20	42	12	0.6	9.40	5.00	22 600
6204T1X	ZZ	VV	20	47	14	1.0	12.8	6.60	20 900
6005T1X	ZZ	VV	25	47	12	0.6	10.1	5.85	19 500
6205T1X	ZZ	VV	25	52	15	1.0	14.0	7.85	18 200
6305T1X	ZZ	VV	25	62	17	1.5	20.6	11.2	16 100
6006T1X	ZZ	VV	30	55	13	1.0	13.2	8.30	16 500
6206T1X	ZZ	VV	30	62	16	1.0	19.5	11.3	15 300
6306T1X	ZZ	VV	30	72	19	2.0	26.7	14.1	13 800
6007T1X	ZZ	VV	35	62	14	1.0	16.0	10.3	14 500
6207T1X	ZZ	VV	35	72	17	1.0	25.7	15.3	13 100
6307T1X	ZZ	VV	35	80	21	2.5	33.5	18.0	12 200
6008T1X	ZZ	VV	40	68	15	1.0	16.8	11.5	13 000
6208T1X	ZZ	VV	40	80	18	1.0	29.1	17.9	11 700
6308T1X	ZZ	VV	40	90	23	2.5	40.5	22.6	10 800
6009T1X	ZZ	VV	45	75	16	1.0	20.9	15.2	11 700
6209T1X	ZZ	VV	45	85	19	1.0	31.5	20.4	10 800
6010T1X	ZZ	VV	50	80	16	1.0	21.8	16.6	10 800

⁽¹⁾ TYA cage available for high-speed motor application. Contact NSK for details.

⁽²⁾ Limiting speed figures are based on T1X.

Adjust the limiting speeds by 115% for TYA cages.



Peripheral Equipment

- GaugesP124-127
 - GR Gauges
 - Features
 - Numbering System
 - GTR Gauges
 - Features
 - Numbering System
 - GN Gauges
 - Features
 - Numbering System
- Bearing MonitorP128
- Bearing HeaterP129
- Grease Replenishing SystemP130-131
- Oil-Air LubricatorP132-133
- Sealed Precision Spacers for Machine Tool SpindlesP134-135

Peripheral Equipment

Ring Gauges GR Series

Housing bore diameter precision measuring gauges

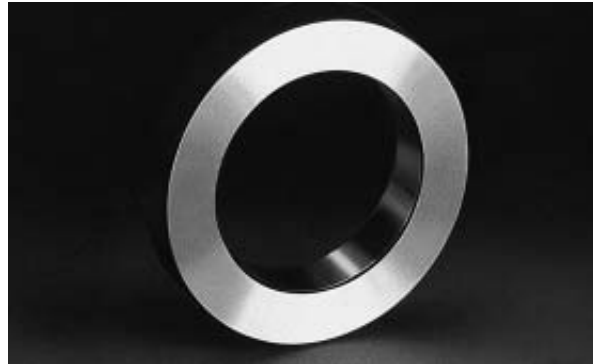

To obtain satisfactory performance of precision rolling bearings for machine tool spindles, it is important to have an accurate fitting with the shaft and housing.

To achieve an accurate fitting, it is necessary to measure the shaft outside diameter and housing bore exactly.

NSK Ring Gauges GR series are master gauges for measuring the bore diameters of housings within an accuracy of 0.001 mm.

Features

- Ring design enables reliable cylinder gauge settings.
- Ring thickness eliminates any deformation caused by measuring pressure.
- Heat treatment during manufacturing of the ring negates any effects of aging on ring dimensions.
- Exact gauging is possible due to precisely measured dimensions that are marked on the gauges in 0.001 mm units in both the X and Y directions.

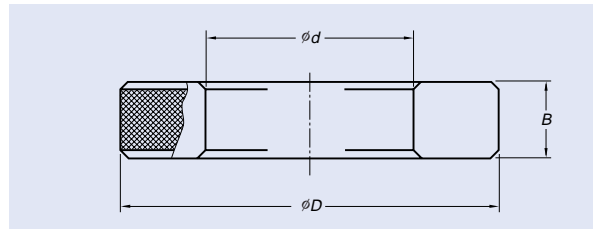

Applicable Bearings					Gauge Numbers	Boundary Dimensions (mm)			Mass (kg) (approx.)
79 NN39 NN49	BNR19 BER19	70 N10 NN30	BNR10 BER10	72 62 N2		d	D	B	
—	—	00	—	—	GR 26	26	75	20	0.6
02	—	01	—	—	GR 28	28	75	20	0.6
03	—	—	—	00	GR 30	30	80	20	0.7
—	—	02	—	01	GR 32	32	80	20	0.7
—	—	03	—	02	GR 35	35	85	20	0.7
04	—	—	—	—	GR 37	37	85	20	0.7
—	—	—	—	03	GR 40	40	90	20	0.8
05	—	04	—	—	GR 42	42	95	20	0.9
06	—	05	—	04	GR 47	47	95	20	0.8
07	—	—	—	05	GR 52	52	100	20	0.9
—	—	06	30	—	GR 55	55	100	20	0.9
08	—	07	35	06	GR 62	62	100	20	0.8
09	—	08	40	—	GR 68	68	110	20	0.9
10	50	—	—	07	GR 72	72	115	20	1.0
—	—	09	45	—	GR 75	75	115	20	0.9
11	55	10	50	08	GR 80	80	120	25	1.2
12	60	—	—	09	GR 85	85	130	25	1.5
13	65	11	55	10	GR 90	90	135	25	1.5
—	—	12	60	—	GR 95	95	140	25	1.6
14	70	13	65	11	GR 100	100	145	25	1.7
15	75	—	—	—	GR 105	105	150	25	1.8
16	80	14	70	12	GR 110	110	160	25	2.1
—	—	15	75	—	GR 115	115	165	25	2.1
17	85	—	—	13	GR 120	120	170	25	2.2
18	90	16	80	14	GR 125	125	175	25	2.3
19	95	17	85	15	GR 130	130	180	25	2.4
20	100	18	90	16	GR 140	140	190	25	2.5
21	105	19	95	—	GR 145	145	200	30	3.5
22	110	20	100	17	GR 150	150	205	30	3.6
—	—	21	105	18	GR 160	160	215	30	3.8
24	120	—	—	—	GR 165	165	220	30	3.9
—	—	22	110	19	GR 170	170	225	30	4.0
26	130	24	120	20	GR 180	180	230	30	3.8
28	140	—	—	21	GR 190	190	240	30	4.0
—	—	26	130	22	GR 200	200	250	30	4.1

Taper Gauges GTR30 Series

Shaft taper measuring gauges



NN30XXKR are tapered bore, double row cylindrical roller bearings that have high rigidity and are suitable for high speeds, so they are often used in machine tool spindles.

To use these bearings, it is important to exactly match the taper of the bearing bore with that of the spindle. The bearing taper (taper 1:12) is precisely controlled and manufactured for a specific accuracy.

A Tapered Gauge

GTR30 is one whose bore is precision finished with a taper identical with that of a bearing. By machining the taper of a spindle to match this taper gauge, its exact contact with the bearing is assured.

Features

- Ring thickness eliminates any deformation caused by measuring pressure.
- Heat treatment during manufacturing of the ring negates any effects of aging on ring dimensions.

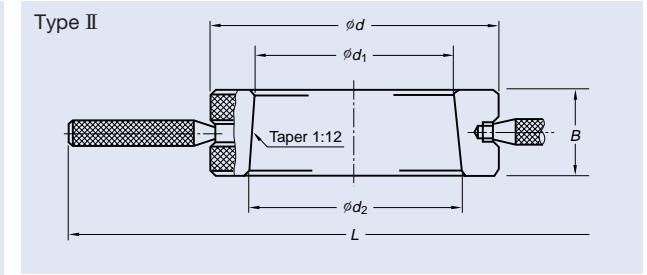
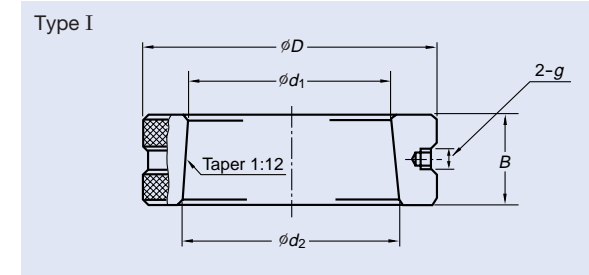

Applicable Bearings	Gauge Numbers	Types	Boundary dimensions (mm)					Mass (kg) (approx.)	
			d ₁	d ₂	D	B	L		g
NN3006KR	GTR3006	I	30	31.583	70	19	—	M3 × 0.5	0.5
NN3007KR	GTR3007	I	35	36.667	75	20	—	M3 × 0.5	0.5
NN3008KR	GTR3008	I	40	41.750	80	21	—	M3 × 0.5	0.6
NN3009KR	GTR3009	I	45	46.917	85	23	—	M5 × 0.8	0.7
NN3010KR	GTR3010	I	50	51.917	90	23	—	M5 × 0.8	0.8
NN3011KR	GTR3011	I	55	57.167	95	26	—	M5 × 0.8	0.9
NN3012KR	GTR3012	I	60	62.167	100	26	—	M5 × 0.8	1.0
NN3013KR	GTR3013	I	65	67.167	105	26	—	M5 × 0.8	1.0
NN3014KR	GTR3014	I	70	72.500	110	30	—	M5 × 0.8	1.3
NN3015KR	GTR3015	I	75	77.500	115	30	—	M5 × 0.8	1.3
NN3016KR	GTR3016	I	80	82.833	125	34	—	M5 × 0.8	1.8
NN3017KR	GTR3017	I	85	87.833	130	34	—	M5 × 0.8	1.9
NN3018KR	GTR3018	II	90	93.083	140	37	358	—	2.5
NN3019KR	GTR3019	II	95	98.083	145	37	363	—	2.6
NN3020KR	GTR3020	II	100	103.083	150	37	368	—	2.7
NN3021KR	GTR3021	II	105	108.417	160	41	376	—	3.5
NN3022KR	GTR3022	II	110	113.750	165	45	381	—	4.0
NN3024KR	GTR3024	II	120	123.833	170	46	386	—	3.9
NN3026KR	GTR3026	II	130	134.333	180	52	396	—	4.6
NN3028KR	GTR3028	II	140	144.417	190	53	406	—	5.0
NN3030KR	GTR3030	II	150	154.667	210	56	426	—	7.0
NN3032KR	GTR3032	II	160	165.000	220	60	436	—	7.8

GN gauges GN30 Series

Precision measuring gauges for residual radial clearance of double-row cylindrical roller bearings (NN30XX)

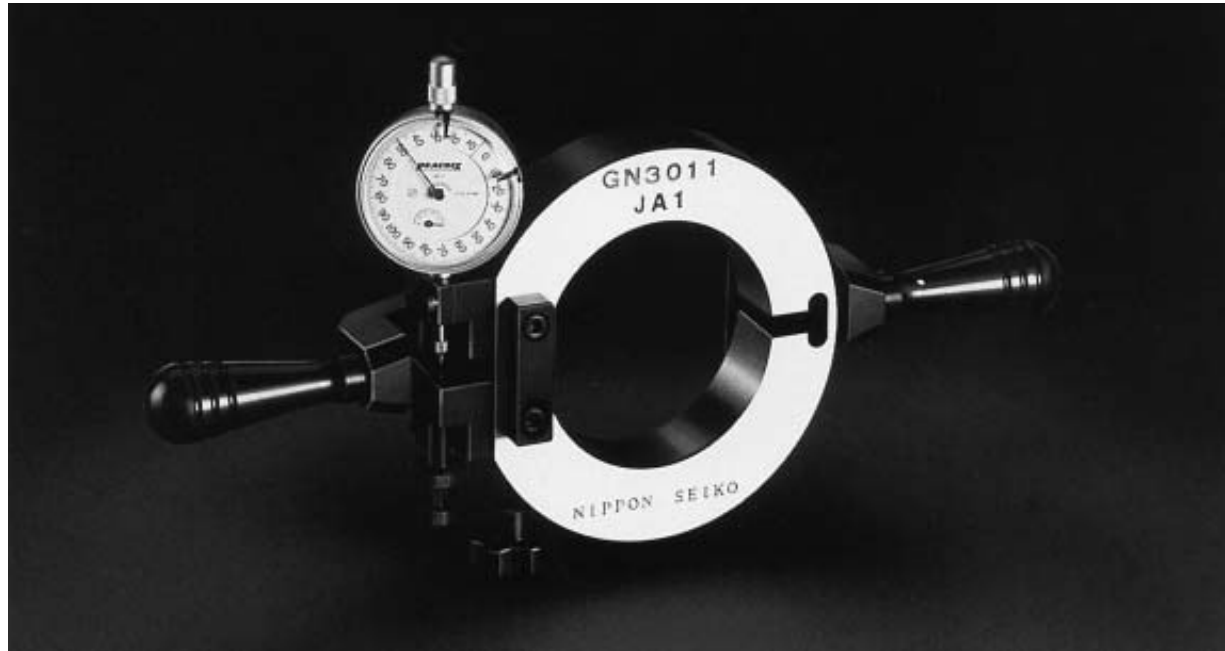

When mounting a double-row cylindrical roller bearing with a tapered bore onto a shaft, it is important to accurately match the spindle taper with that of the bearing, and to ensure that the desired radial internal clearance is attained after mounting.

If there is excessive residual radial internal clearance, the main shaft will have some play and machining accuracy will be adversely affected. If clearance is too small, despite little or no change in rigidity, heat generation will become excessive and rolling fatigue life will be extremely shortened (See page 155).

With the recent trends toward higher speed and higher precision, it is necessary to control residual radial internal clearance more carefully. In the past, radial clearance measuring methods were very difficult and required much skill. GN gauges developed by NSK for residual radial internal clearance measurements of double-row cylindrical roller bearing simplify bearing mounting and improve mounting accuracy. (Use of GN gauges also require a bore measuring cylinder gauge.)

Features

- Simple, reliable, and accurate measurements can be made.
- No more complicated calculations for corrections based on interference of an outer ring with housing.
- Both positive and negative clearance (preload) can be measured.
- Accurate measurements are obtained since all GN gauges are calibrated for measuring pressure.

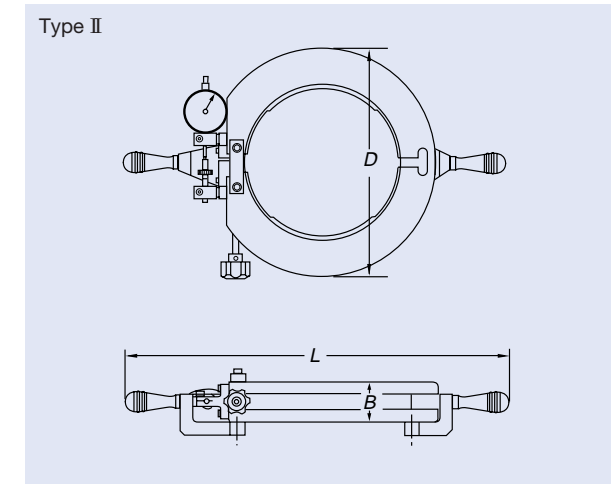
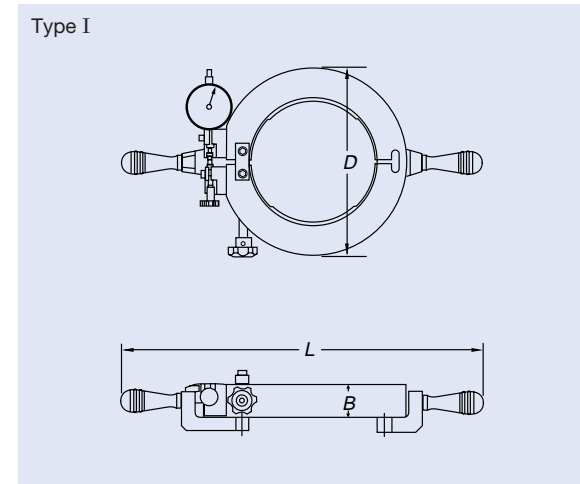

Applicable Bearings	Gauge Numbers	Types	Boundary dimensions (mm)			Mass (kg) (approx.)
			D	B	L	
NN3007	GN3007	I	102	23	292	1.3
NN3008	GN3008	I	108	23	297	1.4
NN3009	GN3009	I	115	23	305	1.5
NN3010	GN3010	I	120	23	310	1.6
NN3011	GN3011	I	131	26	324	2.1
NN3012	GN3012	I	138	26	329	2.2
NN3013	GN3013	I	145	26	335	2.4
NN3014	GN3014	I	156	30	347	3.0
NN3015	GN3015	I	162	30	353	3.1
NN3016	GN3016	I	175	33	374	4.2
NN3017	GN3017	I	185	33	381	4.3
NN3018	GN3018	I	195	35	393	5.2
NN3019	GN3019	I	204	35	399	5.6
NN3020	GN3020	I	210	35	411	6.1
NN3021	GN3021	I	224	39	419	7.1
NN3022	GN3022	I	233	44	433	8.5
NN3024	GN3024	II	254	44	470	7.5
NN3026	GN3026	II	280	50	492	9.5
NN3028	GN3028	II	289	50	500	9.5
NN3030	GN3030	II	314	54	520	12
NN3032	GN3032	II	329	54	540	13

Bearing Monitor NB-4



Microelectronics allow the NB-4 Bearing Monitor (a vibration monitor) to be a conveniently portable size. With high sensitivity and a variety of functions built in, it can quickly and reliably detect unusual vibrations in bearings or machines, and warn of possible trouble.

Features

- Vibrations can be measured and recorded and then displayed as a waveform (recorded by a personal computer or other device).
- The envelope function of the NB-4 makes it possible to detect any damage on the raceway of a bearing.

NB-4 Main Body

- Warning light**
LED flashes if isolated bearing flaws exist.
- Function Switch**
To select displacement, velocity, or acceleration.
- Mode Switch**
To select rms or peak readings and output signals.
- Sensitivity Switch**
To select high or low sensitivity or turn power off.
- Liquid Crystal Display**
Vibration data are shown. Low battery voltage, excessive input, and PEAK mode selection are also indicated.
- Hold Button**
Displayed vibration data (LCD) is held constant.
- Earphone Output**
Vibrational sound may be heard using earphones and the volume controller.
- Output Terminal**
Displays either a vibration waveform or a waveform envelope signal.

Probe Type Pick-up

Hand-held Vibration Pick-up
Superior high-frequency response allows early detection of trouble in bearing and other machine parts.

Helical Cable
A tangle-free, extendable cable may be used to connect the vibration pick-up, or it can be connected directly to the main body.

Optional fixed pick-up
Held by magnet or screw (waterproof)

Helical Cable connected to hand-held probe

NB-4 Main Body connected to hand-held Vibration Pick-up

Bearing Heater



A bearing heater heats a bearing evenly and quickly to fit the bearing on a spindle, thus enabling clean mounting without oil. A bearing heater can be used to heat not only bearings but also ring-shaped metal parts, such as gears.

Features

- Rapid and even heating
- No heating oil is required, thus there is no greasy dirt.
- Suitable for shrinkage fit of bearings as well as ring-shaped metal parts.

User-friendly operation panel

In conjunction with an ultra-compact high sensitive temperature sensor, the heater indicates precise, real-time temperatures through digital display, irrespective of heating speed or detection area.

The heater starts or stops at the flick of a button. The timer can be set for a maximum of 100 minutes.

*External input/output terminals for remote control on-line are featured as standard, enabling factory automation as well.

A superior level of safety

The heater automatically stops promptly if heat is applied without setting the temperature sensor or in the event of a device failure.

Compatible with various sizes of bores

By selecting an I-type core that matches the bore of a bearing, one bearing heater can be compatible with bearings of various sizes.

Automatic heating under optimal conditions

Electrical properties change depending on the type of bearing and I-type core used. The heater automatically detects these changes and thus always applies heat optimally.

Also, as the output is adjustable from 50% to 100% in increments of 10%, the heater is ideal for delicate bearings that require gradual heating.



Dimension Information

0110/0120

Type/Capacity	Power voltage
0110 1KVA	100 V 1φ Common for 50/60 Hz
0120 1KVA	200 V 1φ Common for 50/60 Hz

Applicable bearing sizes

MAX12 kg

Heating performance curve (example)

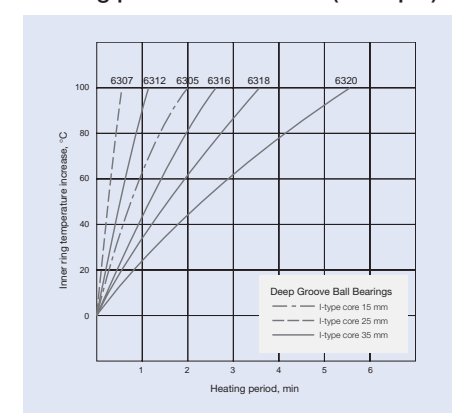

Grease Replenishing System FINE-LUB II



Until recently, high-speed spindles have used oil-air or oil-mist lubrication. Current worldwide concern for the environment requires a new system that reduces noise and oil mist while supporting clean working environment and energy saving. In response to this demand, NSK has developed FINE-LUB II, the world's first grease-replenishing system for high-speed machine tool spindles.

FINE-LUB II feeds a small amount of grease into high-speed bearings at regular intervals and discharges old grease, through an optimally shaped spacer, to a grease storage located in the housing. This technology delivers the world's first grease lubrication system for the high-speed spindles of machine tools and, at the same time, increases the operating lifetime. This revolutionary product completely transforms the concept of grease lubrication. FINE-LUB II leads the way to a new type of grease lubrication, making it faster, accurate, and more comfortable.

Features

Longer operating life for lubricating grease

The operating lifetime of grease is several hundred hours during continuous rotation at a speed of $1.8M d_m n$ (#40 taper 20 000 min⁻¹). FINE-LUB II has been developed with the aim of feeding in an appropriate amount of grease depending upon the rotation speed and bearing size to avoid seizure, thereby ensuring more than 10 000 hours of maintenance-free performance.

Controlling the discharge of lubricating grease to prevent temperature increase.

Feeding too much grease into the inside of a bearing can cause the temperature to increase due to grease churning. To prevent this, FINE-LUB II features a built-in device to ensure that an appropriate amount of grease is discharged.



Bearing shape designed specifically for grease replenishing

● Grease replenishing method

A small amount of grease is fed into a rotating bearing at regular intervals through a grease inlet located near the outer ring raceway.

The grease is fed in small amounts to prevent the bearing temperature from increasing.

● Grease discharging method

A specially shaped spacer for grease discharge, located at the counter-bore side of the bearing, directs old grease into a storage groove, preventing it from re-entering the inside of the bearing.

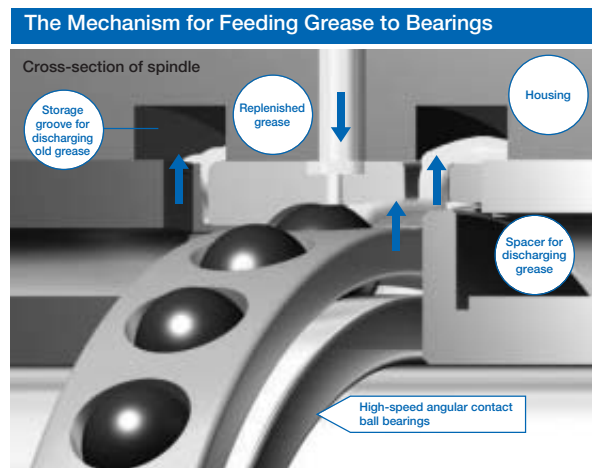

Dimensions

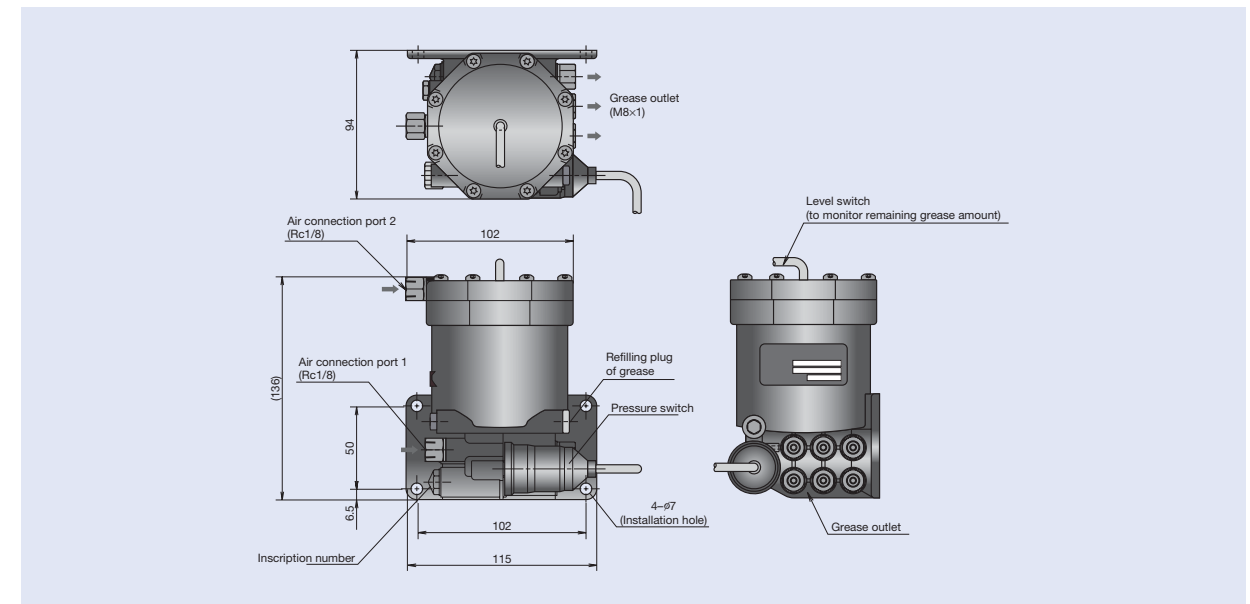

Model Number

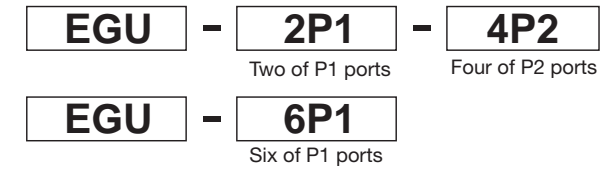

Discharge amount (cc/cycle)	Code number
0.01	P1
0.02	P2

Specifications

Item	Specification
Air feeding pressure	0.25 to 0.4 MPa
Discharge amount	0.01 or 0.02/bearing in a row
Tank capacity	200 cc
Monitoring function	Detection of remaining grease amount, detection of pressure (check of pressure increase)
Pipe length	2.5 m or less
Grease type	MTE grease

System Diagram

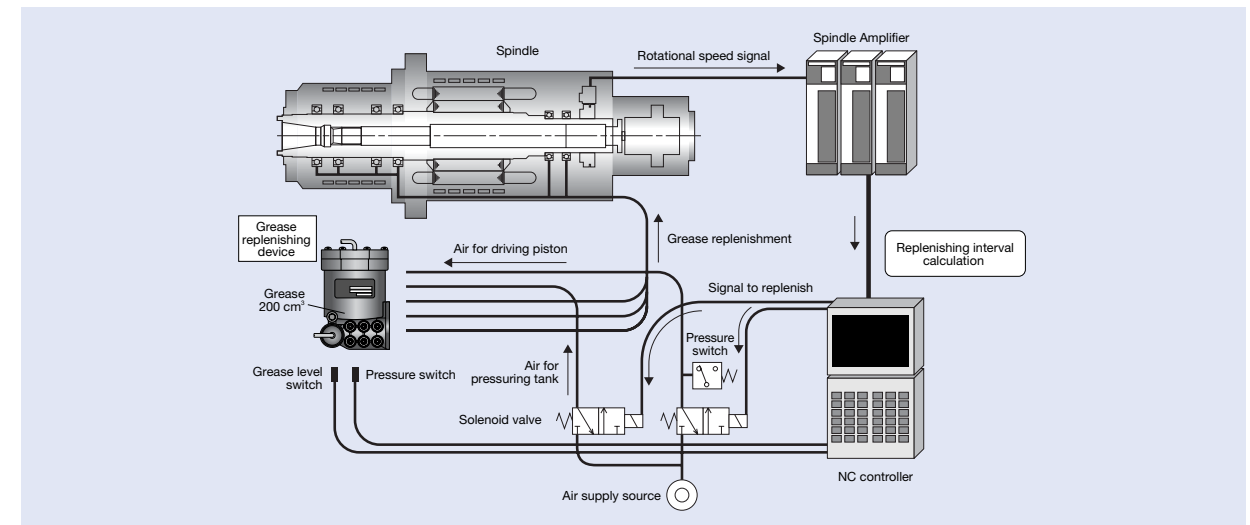

■ FINE-LUB Oil-Air Lubricator

Features

Remarkable technological innovations continue in the field of machine tools. Particularly, spindle motors are operating faster than before. New developments for improving bearing and lubrication methods to facilitate the higher speeds are therefore vital.

NSK has made many developments in oil-air lubrication systems and oil supply equipment. In 1984, NSK introduced the FINE-LUB oil-air lubricator to the market, and continues to enjoy success with this product. The FINE-LUB has evolved with the times, and has been adopted for use in many machine tools, while earning a reputation for excellent performance and high reliability.

The FINE-LUB oil-air lubricator has a leading position in the oil-air lubrication market. This unit provides oil-air lubrication by a system, which consists of a pump, mixing valves, and a control unit. Reliability has been further improved by incorporating safety devices.

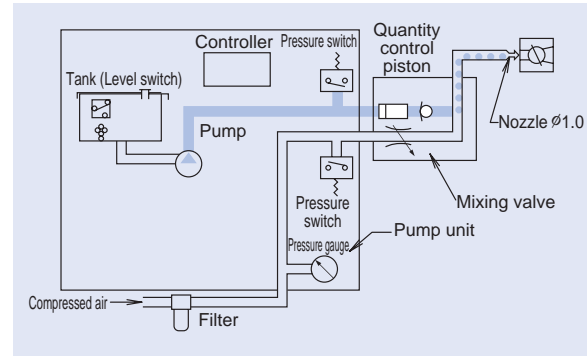

[Precautions]

- Use clean, dry compressed air at a pressure of 0.2–0.4 MPa.
- Use fresh, clean lubricating oil with a viscosity of ISO VG 10 or higher. Please take extra care to avoid oil contamination, which can shorten the life of equipment.
- Take extra care in selecting quality oil lines for use between the pump and mixing valves. Oil lines exceeding 5 m in length require you contact NSK prior to use.
- Oil lines from the mixing valve to the spindle should be limited to 1.5–5 m.

■ OAEM Pump Unit

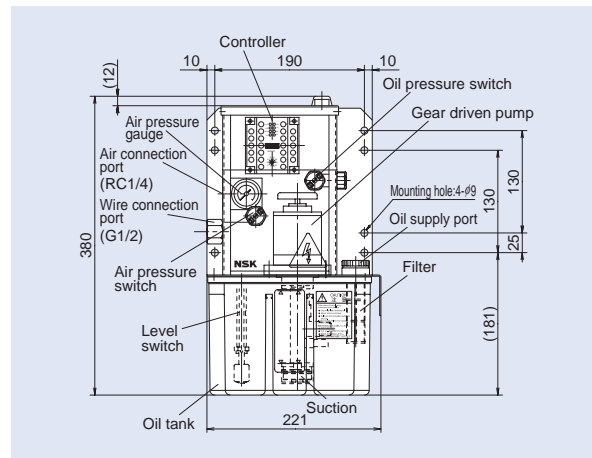

Model number:
 OAEM (Incl. controller)
 OAEM-N (No controller)

- Lubrication: high speed spindle oil, or turbine oil
- Power supply: 100 V
- Tank capacity: 2.7 L
- Effective oil level: 1.7 L

- Components of pump unit: Controller, air pressure switch, Oil pressure switch and Float switch.

NSK also offers a more economical pump unit that is CE Mark approved.

This pump can be controlled exclusively by our controller, or by a machine equipment sequencer.

Features

- The OAEM unit is a newly developed low viscosity gear driven pump.
 (Operating oil viscosity range: 10–68 mm²/s)
- A special controller is used to set lubricating intervals at 1, 2, 4, 8, 16, 24, 32, 48, 64, or 128 minutes.
- Standard safety devices include:
 - ① Oil level switch
 - ② Power failure warning
 - ③ Air pressure switch
 - ④ Oil pressure switch

■ Mixing Valve MVF

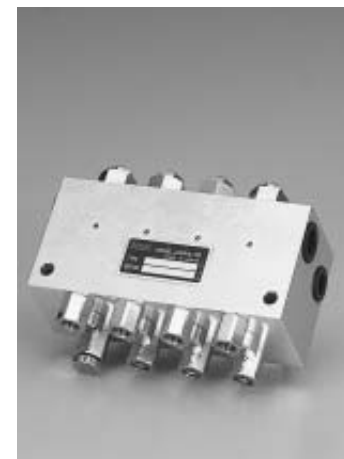
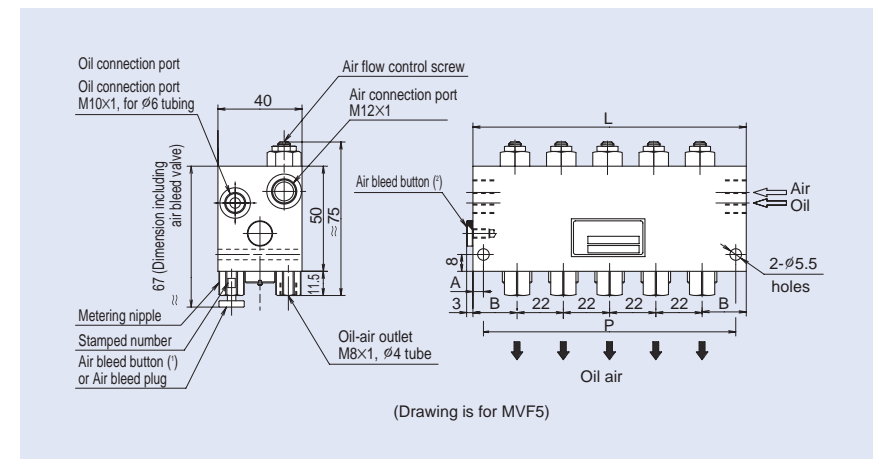

Features

- Adopts a piston-type control for discharging small, fixed quantities of oil.
- Discharged quantities of 0.01, 0.03, and 0.06 cm³ per stroke can be selected.
- Number of outlets and discharge quantities can be selected depending on each condition.

Notes (i) In case the discharged quantity is 0.01 cm³, use Air bleed plug for Air bleed procedure.
 In case the discharged quantity is 0.03 cm³, or 0.06 cm³, attach Air bleed button instead of Air bleed plug, for Air bleed procedure.
 (ii) In case the discharged quantity is 0.03 cm³, or 0.06 cm³, attach the Air bleed button to this position, during the operation.

Type number	Number of valves	L	A	P	B
MVF1	1	42	10	22	21
MVF2	2	64	9.5	45	21
MVF3	3	86	8	70	21
MVF4	4	108	6.5	95	21
MVF5	5	130	5	120	21
MVF6	6	155	5	145	22.5

Discharge quantity (cm ³ /stroke)	Stamping number	Code number
0.01	1	P1
0.03	3	P2
0.06	6	P3

■ Optional Parts

[Pressure switch]

OAG

- Monitors for increases in air and oil pressure and drop in oil pressure.
 (Equipped on OAEM)



[Oil-Air Sensor]

- The oil-air sensor makes it possible to improve the reliability of oil-air lubrication by monitoring oil particles supplied from a mixing valve to a bearing.
- The device can be added later to an existing oil-air system by connecting the device to an oil-air pipe.

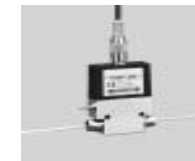

[Oil Filter]

OAV-02/03

- Filters remove minute foreign particles from the oil.
- Two types are available: 3 μm and 20 μm



[Air Bleed Valve]

OAV-01

- Bleed valves facilitate bleeding air after disconnecting oil lines for maintenance of the lubricator.



Sealed Precision Spacers for Machine Tool Spindles



Features

In the past, labyrinth spacers were used to prevent foreign matter from entering a bearing in a spindle. However, because the clearance between inner and outer spacer rings is large, the entry of foreign matter cannot be completely prevented. NSK succeeded in narrowing the gap between them by attaching seals to spacers. The double structure of a labyrinth spacer plus a seal improves the reliability of the spacers.

- Environmentally-sound
Attached seals prevent the leakage of grease
- Enhanced reliability
For grease lubrication, a double-layer structure of a labyrinth spacer plus a seal provides superior resistance against entry of dust and coolant.

The example in the figure on the left contains a triple-seal configuration—the labyrinth seal which consists of the retaining cover and the inner-ring spacer provide the first seal, followed by the sealed precision spacer with an additional built-in labyrinth seal.

Configuration example

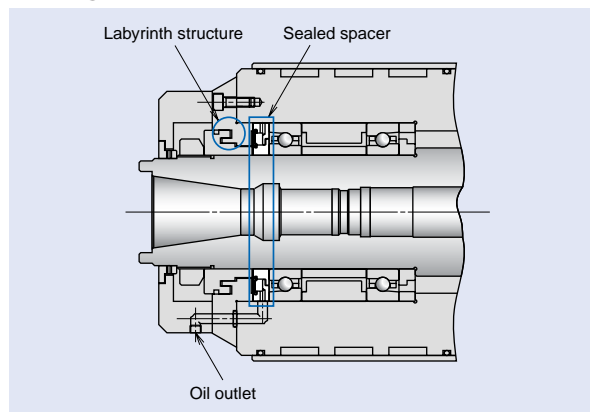

Specification

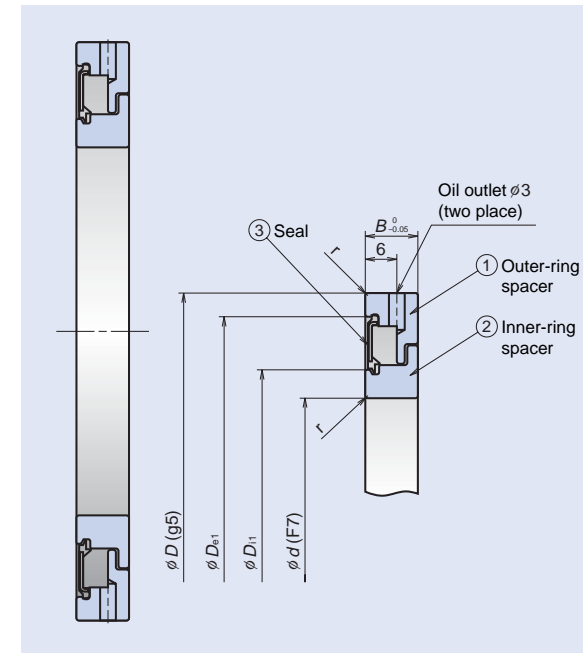

Material for outer-ring spacer	SUJ2
Material for inner-ring spacer	SUJ2
Seal material	Nitrile rubber, SECC

Handling precautions

Note that an inner-ring spacer and an outer-ring spacer can be separated, so take care that rubber seal do not fall out or sustain damage during handling.

Use universal combination bearings (see pages 150-151) with sealed precision spacers.

Numbering system

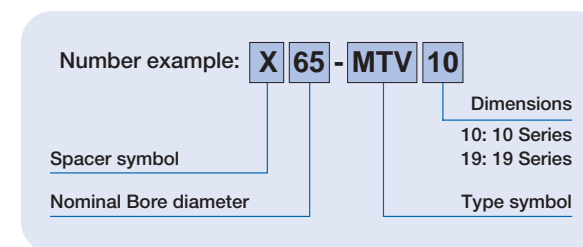

Dimensions (19 Series)

Reference number	Bore diameter ϕd (mm)	Outer diameter ϕD (mm)	Width B (mm)	D_{i1} (mm)	D_{e1} (mm)	Spacer chamber r (mm)
X30-MTV19	30	47	10	34.3	43	0.3
X35-MTV19	35	55	10	39.2	50.5	0.6
X40-MTV19	40	62	10	46.4	58	0.6
X45-MTV19	45	68	10	50	63.5	0.6
X50-MTV19	50	72	10	55.2	67.4	0.6
X55-MTV19	55	80	10	61.7	74.6	1
X60-MTV19	60	85	10	66	80	1
X65-MTV19	65	90	10	71.7	84	1
X70-MTV19	70	100	10	77.5	93	1
X75-MTV19	75	105	10	82.2	98.5	1
X80-MTV19	80	110	10	87.5	103	1
X85-MTV19	85	120	10	94.8	111.6	1.1
X90-MTV19	90	125	10	98.8	118	1.1
X95-MTV19	95	130	10	103.8	122.8	1.1
X100-MTV19	100	140	10	111	131	1.1
X105-MTV19	105	145	10	116	135.4	1.1
X110-MTV19	110	150	10	121	140.4	1.1

Dimensions (10 Series)

Reference number	Bore diameter ϕd (mm)	Outer diameter ϕD (mm)	Width B (mm)	D_{i1} (mm)	D_{e1} (mm)	Spacer chamber r (mm)
X30-MTV10	30	55	10	36.8	49.2	0.5
X35-MTV10	35	62	10	41.6	56	0.5
X40-MTV10	40	68	10	47.5	62	0.5
X45-MTV10	45	75	10	53.5	69	0.5
X50-MTV10	50	80	10	58.5	74	0.5
X55-MTV10	55	90	10	64.4	82	0.5
X60-MTV10	60	95	10	69.4	87	0.5
X65-MTV10	65	100	10	73	92	0.5
X70-MTV10	70	110	10	80.8	101	0.5
X75-MTV10	75	115	10	85.8	106	0.5
X80-MTV10	80	125	10	91.4	114.6	0.5
X85-MTV10	85	130	10	96.4	119.6	0.5
X90-MTV10	90	140	10	103	127.8	0.8
X95-MTV10	95	145	10	108.5	134.5	0.8
X100-MTV10	100	150	10	112.5	137.8	0.8
X105-MTV10	105	160	10	120.4	148.5	1
X110-MTV10	110	170	10	124.6	155.5	1
X120-MTV10	120	180	10	134.6	165.5	1



Technical Guide

- 1. LifeP138-145
 - Rolling Fatigue Life and Basic Load Rating
 - New Life Theory
- 2. Static Load Ratings and Static Equivalent Loads P146-147
- 3. Angular Contact Ball Bearing CombinationsP148-151
 - Features of Each Combination
 - Universal Combination
- 4. Preload and RigidityP152-169
 - Types of Preload and Rigidity
 - Preload and Rigidity Tables
- 5. Limiting SpeedsP170-171
- 6. LubricationP172-175
- 7. Bearing TolerancesP176-183
 - Tolerance for Radial Bearings
 - Tolerances for Tapered Bores
 - Tolerances for Angular Contact Thrust Ball Bearings
- 8. Designing of Shafts and HousingsP184-188
 - Fitting of Shafts and Housings
 - Shafts and Housing Tolerance
 - Shoulder and Fillet Dimensions
 - Chamfer Dimensions
- 9. SpacersP189-193
 - Spacer Dimensions
 - Position of Spray Nozzle

Technical Guide

Life

Static Load Ratings and Static Equivalent Loads

Angular Contact Ball Bearing Combinations

Preload and Rigidity

Limiting Speeds

Lubrication

Bearing Tolerances

Design of Shafts and Housings

Spacers

Rolling Fatigue Life and Basic Load Rating Bearing Life

The various functions required of rolling bearings vary according to the bearing application. These functions must be performed for a prolonged period. Even if bearings are properly mounted and correctly operated, they will eventually fail to perform satisfactorily due to an increase in noise and vibration, loss of running accuracy, deterioration of grease, or fatigue flaking of the rolling surfaces.

Bearing life, in the broad sense of the term, is the period during which bearings continue to operate and to satisfy their required functions. This bearing life may be defined as noise life, abrasion life, grease life, or rolling fatigue life, depending on which one causes loss of bearing service.

Aside from the failure of bearings to function due to natural deterioration, bearings may fail when conditions such as heat-seizure, fracture, scoring of the rings, wear of the seals, or other damage occurs. Conditions such as these should not be interpreted as normal bearing failure since they often occur as a result of errors in bearing selection, improper design or manufacture of the bearing surroundings, incorrect mounting, or insufficient maintenance.

Rolling Fatigue Life and Basic Rating Life

When rolling bearings are operated under load, the raceways of their inner and outer rings and rolling elements are subjected to repeated cyclic stress. Because of metal fatigue of the rolling contact surfaces of the raceways and rolling elements, scaly particles may separate from the bearing material.

This phenomenon is called "flaking". Rolling fatigue life is represented by the total number of revolutions at which time the bearing surface will start flaking due to stress. This is called fatigue life. Even for seemingly identical bearings, which are of the same type, size, and material and receive the same heat treatment and other processing, the rolling fatigue life varies greatly, even under identical operating conditions. This is because the flaking of materials due to fatigue is subject to many other variables. Consequently, "basic rating life", in which rolling fatigue life is treated as a statistical phenomenon, is used in preference to actual rolling fatigue life.

Suppose a number of bearings of the same type are operated individually under the same conditions. After a certain period of time, 10% of them fail as a result of flaking caused by rolling fatigue. The total number of revolutions at this point is defined as the basic rating life or, if the speed is constant, the basic rating life is often expressed by the total number of operating hours completed when 10% of the bearings become

inoperable due to flaking.

In determining bearing life, basic rating life is often the only factor considered. However, other factors must also be taken into account. For example, the grease life of grease-prelubricated bearings can be estimated. Since noise life and abrasion life are determined according to individual standards for different applications, specific values for noise or abrasion life must be determined empirically.

Basic Dynamic Load Rating

The basic dynamic load rating is defined as the constant load applied on bearings with stationary outer rings that the inner rings can endure for a rating life of one million revolutions (10^6 rev). The basic load rating of radial bearings is defined as a central radial load of constant direction and magnitude, while the basic load rating of thrust bearings is defined as an axial load of constant magnitude in the same deflection as the central axis. The load ratings are listed under C_r for radial bearings and C_a for thrust bearings in the dimension tables.

Basic Rating Life

The following relation exists between bearing load and basic rating life:

$$\begin{aligned} \text{For ball bearings} \quad L_{10} &= \left(\frac{C}{P}\right)^3 \\ L_{10} &= \frac{10^6}{60n} \left(\frac{C}{P}\right)^3 \quad (\text{h}) \end{aligned}$$

$$\begin{aligned} \text{For roller bearings} \quad L_{10} &= \left(\frac{C}{P}\right)^{10/3} \\ L_{10} &= \frac{10^6}{60n} \left(\frac{C}{P}\right)^{10/3} \quad (\text{h}) \end{aligned}$$

where

- L_{10} : Basic rating life (10^6 rev, or h)
- P : Bearing load (equivalent load) (N)
(Refer to Page 125)
- C : Bearing dynamic load rating (N)
For radial bearings, C is written C_r
For thrust bearings, C is written C_a
- n : Rotational Speed (min^{-1})

In the case of bearings that run at a constant speed, it is convenient to express the fatigue life in terms of hours.

Dynamic Equivalent Load

In some cases, the loads applied on bearings are purely radial or axial loads; however, in most cases, the loads are a combination of both. In addition, such loads usually fluctuate in both magnitude and direction.

In such cases, the loads actually applied on bearings cannot be used for bearings life calculations; therefore, a hypothetical load should be estimated that has a constant magnitude and passes through the center of the bearing, and will give the same bearing life that the bearing would attain under actual conditions of load and rotation. Such a hypothetical load is called the dynamic equivalent load.

Assuming the equivalent radial load as P_r , the radial load as F_r , the axial load as F_a , and the contact angle as α , the relationship between the equivalent radial load and bearing load can be approximated as follows:

$$P_r = XF_r + YF_a$$

where

- X : Radial load factor
- Y : Axial load factor

} See Table 1.1

The axial load factor varies depending on the contact angle. In the case of roller bearings, the contact angle remains the same regardless of the magnitude of the axial load. In the case of single row deep groove ball bearings and angular contact ball bearings, the contact angle increases when the axial load is increased. Such change in the contact angle can be expressed by the ratio of the basic static load rating C_{0r} and axial load F_a . Table 1.1 shows the axial load factor at the contact angle corresponding to this ratio. Regarding angular contact ball bearings, the effect of change in the contact angle on the load factor may be ignored under normal conditions even if the contact angle is as large as 25° , 30° or 40° .

For the thrust bearing with the contact angle of $\alpha \neq 90^\circ$ receiving both radial and axial loads simultaneously, the equivalent axial load P_a becomes as follows:

$$P_a = XF_r + YF_a$$

Table 1.1 Value of Factors X and Y

Normal Contact Angle	$i f_0 F_a^* / C_{0r}$	e	Single, DT				DB or DF			
			$F_a / F_r \leq e$		$F_a / F_r > e$		$F_a / F_r \leq e$		$F_a / F_r > e$	
			X	Y	X	Y	X	Y	X	Y
15	0.178	0.38				1.47		1.65		2.39
	0.357	0.40				1.40		1.57		2.28
	0.714	0.43				1.30		1.46		2.11
	1.070	0.46				1.23		1.38		2.00
	1.430	0.47	1	0	0.44	1.19	1	1.34	0.72	1.93
	2.140	0.50				1.12		1.26		1.82
	3.570	0.55				1.02		1.14		1.66
	5.350	0.56				1.00		1.12		1.63
18	—	0.57	1	0	0.43	1.00	1	1.09	0.70	1.63
25	—	0.68	1	0	0.41	0.87	1	0.92	0.67	1.41
30	—	0.80	1	0	0.39	0.76	1	0.78	0.63	1.24
40	—	1.14	1	0	0.35	0.57	1	0.55	0.57	0.93
50	—	1.49	—	—	0.73	1	1.37	0.57	0.73	1
55	—	1.79	—	—	0.81	1	1.60	0.56	0.81	1
60	—	2.17	—	—	0.92	1	1.90	0.55	0.92	1

*For i , use 2 for DB, DF and 1 for DT

Table 1.2 Basic Load Rating of ACBB as Multiple Sets

Double Row		Triple Row		Quadruple Row	
C_r	C_{0r}	C_r	C_{0r}	C_r	C_{0r}
1.62 times relative to Single row	2 times relative to Single row	2.15 times relative to Single row	3 times relative to Single row	2.64 times relative to Single row	4 times relative to Single row

Life Calculation of Multiple Bearings as a Group

When multiple rolling bearings are used in one machine, the fatigue life of individual bearings can be determined if the load acting on individual bearings is known. Generally, however, the machine becomes inoperative if a bearing in any part fails. It may therefore be necessary in certain cases to know the fatigue life of a group of bearings used in one machine.

The fatigue life of the bearings varies greatly and our fatigue life calculation equation $L_{10} = \left(\frac{C}{P}\right)^3$ applies to the 90% life (also called the rating fatigue life, which is either the gross number of revolution or hours to which 90% of multiple similar bearings operated under similar conditions can reach).

In other words, the calculated fatigue life for one bearing has a probability of 90%. Since the endurance probability of a group of multiple bearings for a certain period is a product of the endurance probability of individual bearings for the same period, the rating fatigue life of a group of multiple bearings is not determined solely from the shortest rating fatigue life among the individual bearings. In fact, the group life is much shorter than the life of the bearing with the shortest fatigue life.

Assuming the rating fatigue life of individual bearings as $L_1, L_2, L_3 \dots L_n$ and the rating fatigue life of the entire group of bearings as L , the below equation is obtained :

$$\frac{1}{L^e} = \frac{1}{L_1^e} + \frac{1}{L_2^e} + \frac{1}{L_3^e} + \dots + \frac{1}{L_n^e}$$

where, $e = 1.1$ (both for ball and roller bearings)

Life Calculations of Preloaded Angular Contact Ball Bearings

To establish the total radial (F_r) and axial (F_a) load components on each bearing in a multiple arrangement of preloaded angular contact ball bearings, the externally applied radial load (F_{re}) and axial load (F_{ae}), the axial preload (F_{ao}) and the load distribution must be taken into account. The latter is a function of the rolling element to raceway deflection which is proportional to (load)^{2/3}. The calculation procedure for popular mounting variations of identical bearings is detailed below.

Back-to-back, Pair of Bearings

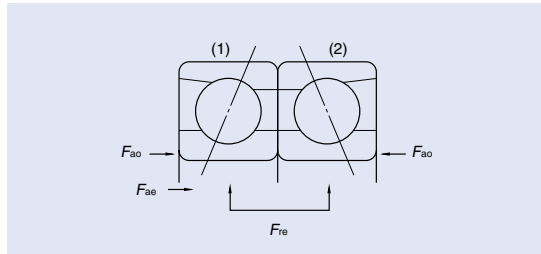

Under external radial load (F_{re}), total Preload (F_{ap}) is the following:

$$F_{ap} = \frac{F_{re} \times 1.2 \times \tan \alpha + F_{ao}}{2}$$

when $F_{ap} < F_{ao}$, use $F_{ap} = F_{ao}$

Total axial component of (F_{a1}, F_{a2}) with applied axial load on each bearing (1 and 2):

$$F_{a1} = 2/3 F_{ae} + F_{ap}$$

$$F_{a2} = F_{ap} - 1/3 F_{ae}$$

when $F_{a2} < 0$ the preload is relieved so that $F_{a1} = F_{ao}$, and $F_{a2} = 0$

Total radial component of load (F_r) on each bearing is proportioned by the ratio of the axial load on each bearing to the total axial load, each component raised to the power of 2/3:

$$F_{r1} = \frac{F_{a1}^{2/3}}{F_{a1}^{2/3} + F_{a2}^{2/3}} \times F_{re}$$

$$F_{r2} = \frac{F_{a2}^{2/3}}{F_{a1}^{2/3} + F_{a2}^{2/3}} \times F_{re}$$

The dynamic equivalent radial load (P_{r1}) and (P_{r2}) for each bearing is calculated from:

$$P_{r1} = XF_{r1} + YF_{a1}$$

$$P_{r2} = XF_{r2} + YF_{a2}$$

The values of X and Y are obtained from Table 1.1 (Page 139)

The basic rating life (L_{10}) of each bearing is:

$$L_{10(1)} = \frac{16\ 667}{n} \left(\frac{C_r}{P_{r1}}\right)^3 \quad (\text{h})$$

$$L_{10(2)} = \frac{16\ 667}{n} \left(\frac{C_r}{P_{r2}}\right)^3 \quad (\text{h})$$

The two bearings may be considered as a unit and according to the theory of probability, the life of the unit, or pair of bearings, will be shorter than the shortest rating life of the individual bearings. Thus:

$$L_{10} = \frac{1}{\left(\frac{1}{L_{10(1)}^{1.1}} + \frac{1}{L_{10(2)}^{1.1}}\right)^{1.1}} \quad (\text{h})$$

DBD Set of Bearings

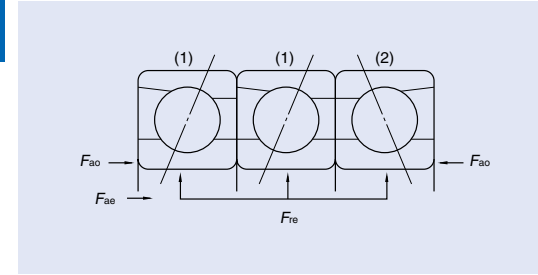

Under external radial load (F_{re}), total Preload (F_{ap}) is the following:

$$F_{ap1} = \frac{F_{re} \times 1.2 \times \tan \alpha + F_{ao}}{4}$$

$$F_{ap2} = \frac{F_{re} \times 1.2 \times \tan \alpha + F_{ao}}{2}$$

when $F_{ap1} < F_{ao}/2$, use $F_{ap1} = F_{ao}/2$

and $F_{ap2} < F_{ao}$, use $F_{ap2} = F_{ao}$

Total axial component of load (F_{a1}, F_{a2}) on each bearing with applied axial load :

$$F_{a1} = 0.4 F_{ae} + F_{ap1}$$

$$F_{a2} = F_{ap2} - 0.2 F_{ae}$$

When $F_{a2} < 0$ the preload is relieved so that

$$F_{a1} = \frac{F_{ae}}{2} \text{ and } F_{a2} = 0$$

Total radial component of load (F_r) on each bearing :

$$F_{r1} = \frac{F_{a1}^{2/3}}{2F_{a1}^{2/3} + F_{a2}^{2/3}} \times F_{re}$$

$$F_{r2} = \frac{F_{a2}^{2/3}}{2F_{a1}^{2/3} + F_{a2}^{2/3}} \times F_{re}$$

The dynamic equivalent radial load (P_{r1}) and (P_{r2}) for each bearing :

$$P_{r1} = XF_{r1} + YF_{a1}$$

$$P_{r2} = XF_{r2} + YF_{a2}$$

The values of X and Y are obtained from Table 1.1, page 139. The basic rating life (L_{10}) of each bearing :

$$L_{10(1)} = \frac{16\ 667}{n} \left(\frac{C_r}{P_{r1}}\right)^3 \quad (\text{h})$$

$$L_{10(2)} = \frac{16\ 667}{n} \left(\frac{C_r}{P_{r2}}\right)^3 \quad (\text{h})$$

$$L_{10} \text{ for the unit} = \frac{1}{\left(\frac{1}{L_{10(1)}^{1.1}} + \frac{1}{L_{10(2)}^{1.1}}\right)^{1.1}} \quad (\text{h})$$

DBB Set of Bearings

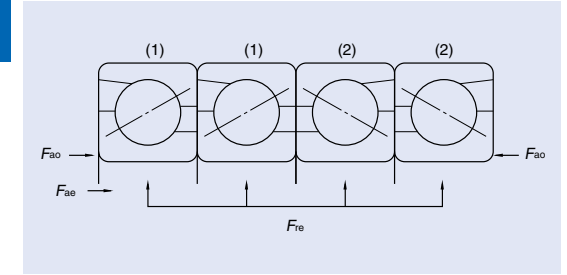

Under external radial load (F_{re}), total Preload (F_{ap}) is the following:

$$F_{ap} = \frac{F_{re} \times 1.2 \times \tan \alpha + F_{ao}}{4}$$

When $F_{ap} < F_{ao}/2$, use $F_{ap} = F_{ao}/2$

Total axial component of load (F_{a1}, F_{a2}) on each bearing with applied axial load

$$F_{a1} = 1/3 F_{ae} + F_{ap}$$

$$F_{a2} = F_{ap} - 1/6 F_{ae}$$

When $F_{a2} < 0$ the preload is relieved so that

$$F_{a1} = \frac{F_{ae}}{2} \text{ and } F_{a2} = 0$$

Total radial component of load (F_r) on each bearing :

$$F_{r1} = \frac{F_{a1}^{2/3}}{F_{a1}^{2/3} + F_{a2}^{2/3}} \times \frac{F_{re}}{2}$$

$$F_{r2} = \frac{F_{a2}^{2/3}}{F_{a1}^{2/3} + F_{a2}^{2/3}} \times \frac{F_{re}}{2}$$

The dynamic equivalent radial load (P_{r1}) and (P_{r2}) for each bearing :

$$P_{r1} = XF_{r1} + YF_{a1}$$

$$P_{r2} = XF_{r2} + YF_{a2}$$

The values of X and Y are obtained from Table 1.1, page 139. The basic rating life (L_{10}) of each bearing :

$$L_{10(1)} = \frac{16\ 667}{n} \left(\frac{C_r}{P_{r1}}\right)^3 \quad (\text{h})$$

$$L_{10(2)} = \frac{16\ 667}{n} \left(\frac{C_r}{P_{r2}}\right)^3 \quad (\text{h})$$

$$L_{10} \text{ for the unit} = \frac{1}{\left(\frac{1}{L_{10(1)}^{1.1}} + \frac{1}{L_{10(2)}^{1.1}}\right)^{1.1}} \quad (\text{h})$$

New Life Theory

Introduction

Bearing technology has advanced rapidly in recent years, particularly in the areas of dimensional accuracy and material cleanliness. As a result, bearings can now have a longer rolling fatigue life in a cleaner environment, than the life obtained by the traditional ISO life calculation formula. This extended life is partly due to the important advancements in bearing related technology such as lubrication cleanliness and filtration.

The conventional life calculation formula, based on the theories of G. Lundberg and A. Palmgren (L-P theory, hereafter) addresses only sub-surface originated flaking. This is the phenomenon in which cracks initially occur due to dynamic shear stress immediately below the rolling surface then progressively reach the surface in the form of flaking.

$$1n \frac{1}{S} \propto \frac{\tau_0^c \cdot N^e \cdot V}{Z_0^h}$$

NSK's new life calculation formula theorizes that rolling fatigue life is the sum total of the combined effects of both sub-surface originated flaking and surface originated flaking occurring simultaneously.

NSK New Life Calculation Formula

(1) Sub-surface originated flaking

A pre-condition of sub-surface originated flaking of rolling bearings is contact of the rolling elements with the raceway via a sufficient and continuous oil film under clean lubrication conditions.

Fig. 1.1 plots the L_{10} life for each test condition with maximum surface contact pressure (P_{max}) and the number of repeated stresses applied on the ordinate and the abscissa, respectively.

In the figure, line L_{10} theoretical is the theoretical line obtained using the conventional life calculation formula. As maximum surface contact pressure decreases, the actual life line separates from the line created by using conventional theoretical calculation and moves towards longer life. This separation suggests the presence of fatigue load limit P_u below which no rolling fatigue occurs. This is better illustrated in Fig. 1.2.

Fig. 1.1 Life Test Result under Clean Lubrication Condition

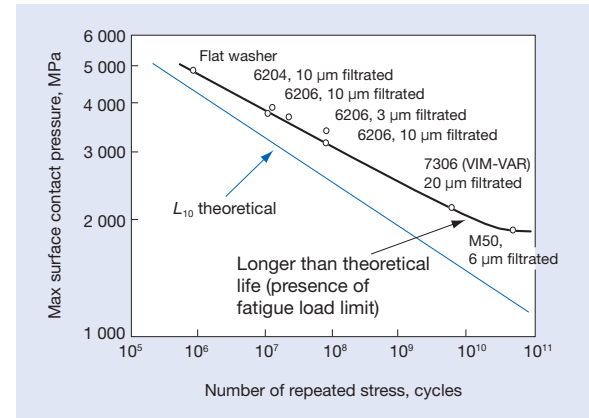
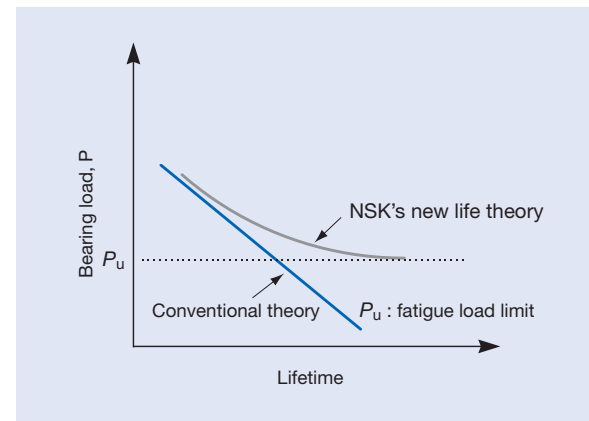

Fig. 1.2 NSK's New Life Theory That Considers Fatigue Limit



(2) Surface originated flaking

Under actual bearing operation, the lubricant is often contaminated with foreign objects such as metal chips, burrs, cast sand, etc.

When the foreign particles are mixed in the lubricant, the particles are pressed onto the raceways by the rolling elements and dents occur on the surfaces of the raceways and rolling elements. Stress concentration occurs at the edges of the dents, generating fine cracks, which over time, propagate into flaking of the raceways and rolling elements.

As shown in Fig. 1.3, the actual life is shorter than conventional calculated life, under conditions of contaminated lubrication at low max surface pressure. The actual life line separates from the line created by theoretical life calculations and moves towards a shorter life. This result shows that the actual life under contaminated lubrication is further shortened compared to the theoretical life because of the decrease in maximum surface contact pressure.

Table 1.3 Value of Contamination Coefficient a_c

	Very clean	Clean	Normal	Contaminated	Heavily contaminated
a_c factor	1	0.8	0.5	0.4-0.1	0.05
Application guide	10 μ m filtration	10-30 μ m filtration	30-100 μ m filtration	Greater than 100 μ m filtration or no filtration (oil bath, circulating lubrication, etc.)	No filtration, presence of many fine particles
Application examples	Sealed grease lubricated bearing for electrical appliances and information technology equipment, etc.	Sealed grease lubricated bearing for electric motors Sealed grease bearing for railway axle boxes and machine tools, etc.	Normal usage Automotive hub unit bearing, etc.	Bearing for automotive transmission; Bearing for industrial gearbox; Bearing for construction machine, etc.	—

Fig. 1.3 Life Test Result under Contaminated Lubrication Condition

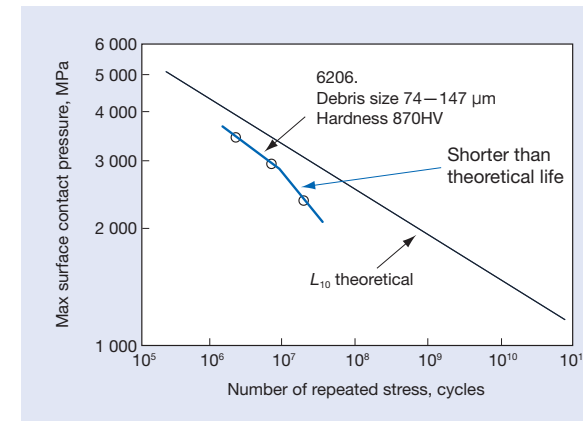

Therefore, the NSK new life calculation formula considers the trend in the results of the life test under conditions of clean environment and at low load zone. Based on these results, the new life equation is a function of $(P-P_u)/C$, which is affected by specific lubrication conditions identified by the lubrication parameter. Also, it is assumed that effects of different types and shapes of foreign particles are strongly influenced by the bearing load and lubrication conditions present, and that such a relationship can be expressed as a function of the load parameter. This relationship of the new life calculation formula is defined by $(P-P_u)/C \cdot 1/a_c$.

Calculation formula for surface originated flaking, based on the above concept, is as follows:

$$1n \frac{1}{S} \propto N^e \int_V \frac{(\tau - \tau_u)^c}{Z_0^h} dV \times \left\{ \frac{1}{f(a_c, a_L)} - 1 \right\}$$

V = stress volume

The contamination coefficient in terms of lubrication cleanliness is shown in Table 1.3. Test results on ball and roller bearings with grease lubrication and clean filtration show the life as being a number of times longer than that of the contaminated calculation. Yet when the foreign object is harder than Hv350, hardness becomes a factor and a dent appears on the raceway. Fatigue damage from these dents, can progress to flaking in a short time. Test results on ball and roller bearings under conditions of foreign object contamination show from 1/3 to 1/10 the life when compared with conventionally calculated life.

Based on these test results, the contamination coefficient a_c is classified into five steps for NSK's new life theory.

(3) New life calculation formula

The following formula, which combines sub-surface originated flaking and surface originated flaking, is proposed as the new life calculation formula.

$$1n \frac{1}{S} \propto N^e \int_V \frac{(\tau - \tau_u)^c}{Z_0^h} dV \times \left\{ \frac{1}{f(a_c, a_L)} \right\}$$

$$L_{able} = a_1 \cdot a_{NSK} \cdot L_{10}$$

Life Correction Factor a_{NSK}

The life correction factor a_{NSK} is the function of lubrication parameter $(P-P_u)/C \cdot 1/a_c$ as shown below:

$$a_{NSK} \propto F \left\{ a_L, \left(\frac{P-P_u}{C \cdot a_c} \right) \right\}$$

NSK's new life theory considers the life extending affect of improved material and heat treatment by correcting the contamination factor a_c . The theory also utilizes viscosity ratio k ($k = \nu/\nu_1$ where ν is the operational viscosity and ν_1 the required viscosity) because the lubrication parameter a_L changes with the degree of oil film formation, based on the lubricant and operating temperature. The theory indicates that the better the lubrication conditions (higher k) the longer the life.

Figures 1.4 and 1.5 show the diagrams of the correction factor a_{NSK} as a function of the new life calculation formula. Also in this new life calculation formula, point contact and line contact are considered separately for ball and roller bearings respectively.

New Life Calculation Formula L_{able}

The concept of new life calculation formula is simplified into one factor as shown by the formula below in which conventional life calculation formula (L_{10}) is multiplied with correction factor (a_{NSK}) and reliability factor (a_1 ; Table 1.4):

$$L_{able} = a_1 \cdot a_{NSK} \cdot L_{10}$$

Table 1.4 Reliability Factor

Reliability (%)	90	95	96	97	98	99
Reliability Factor	1.00	0.62	0.53	0.44	0.33	0.21

Fig. 1.4 New Life Calculation Diagram for Ball Bearings

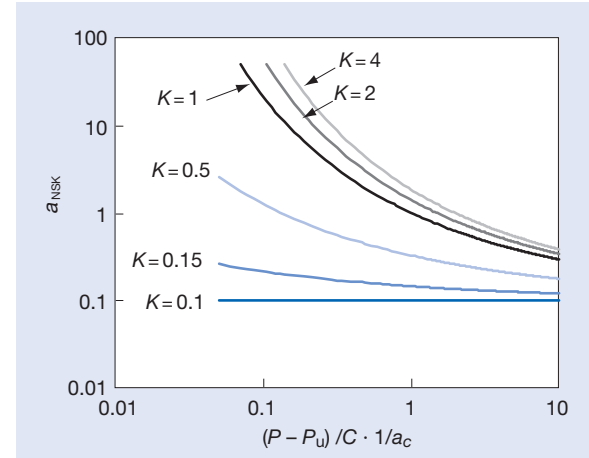
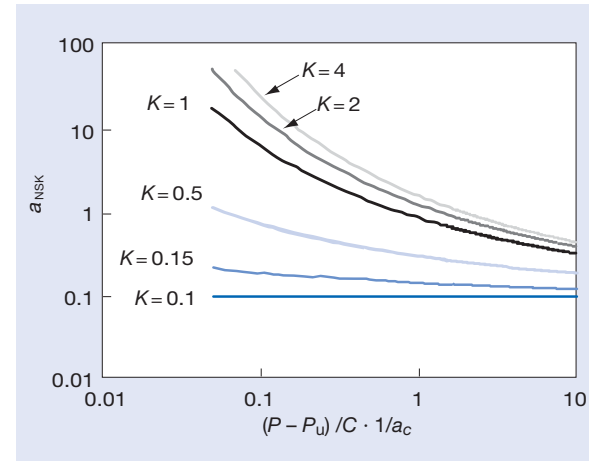

Fig. 1.5 New Life Calculation Diagram for Roller Bearings



To Access the NSK Calculation Tools

Visit our website at <http://www.nsk.com>

Life of High Speed Bearings

When bearings operate at high speed, in addition to the external load, the internal load generated by the centrifugal force acting on the rolling element must be taken into account. A computer should be used for the calculation of the load conditions on bearings operation at high speeds (in excess of $800\,000 d_m n$).

Balance among the forces acting on the rolling elements and inner/outer rings as well as changes in contact angle are obtained by using convergence calculations⁽¹⁾, based on the load condition of the bearing (radial load, axial load, centrifugal force on rolling elements, etc.).

Life is initially calculated for each individual rolling element under load between inner and outer ring and then the life of the entire single row of bearing is obtained.

⁽¹⁾ Convergence calculations allow NSK to calculate with great accuracy the centrifugal force exerted on balls and to actually perform load calculations for each rolling element.

For life calculations on bearings used in high speed applications, please contact NSK.

Life of Ceramic Hybrid Bearings

C_r , C_{or} values and L_{10} standards do not exist in ISO281 for ceramic bearings.

However, ceramic bearing life tends to be longer than that of conventional steel ball bearings, under the same appropriate operating conditions.

This may be especially true in the situations where the centrifugal force on the balls are significant.

Fig. 1.6 Change in Contact Angle Due to Centrifugal Force

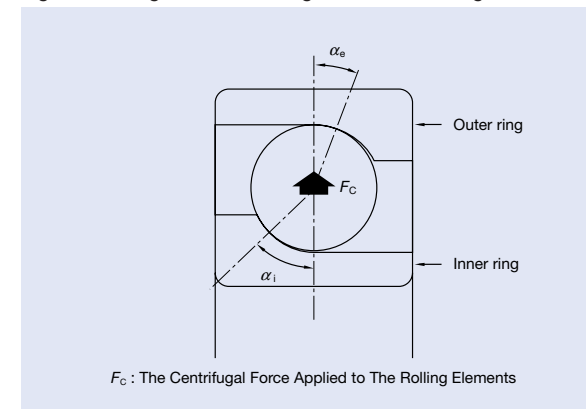

Static Load Ratings

When subjected to an excessive load or a strong shock load, rolling bearings may incur a local permanent deformation of the rolling elements and raceway surface if the elastic limit is exceeded. The nonelastic deformation increases in area and depth as the load increases, and when the load exceeds a certain limit, the smooth running of the bearing is impeded. The basic static load rating is defined as that static load which produces the following calculated contact stress at the center of the contact area between the rolling element subjected to the maximum stress and the raceway surface.

For ball bearings : 4 200MPa
For roller bearings : 4 000MPa

In this most heavily contacted area, the sum of the permanent deformation of the rolling element and that of the raceway is nearly 0.0001 times the rolling element's diameter. The basic static load rating C_0 is written C_{0r} for radial bearings and C_{0a} for thrust bearings in the bearing tables.

Fig. 2.1 The Relation between Indentations and Basic Static Load Rating

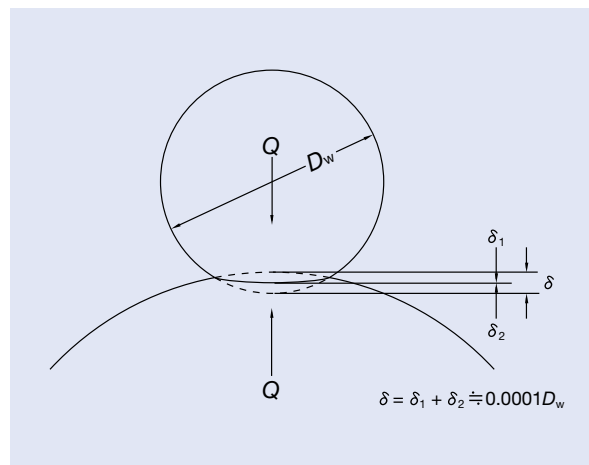

Static Equivalent Loads

The static equivalent load is a hypothetical load that produces a contact stress equal the maximum stress under actual conditions, while the bearing is stationary (including very slow rotation or oscillation), in the area of contact between the most heavily stressed rolling element and bearing raceway.

The static radial load passing through the bearing center is taken as the static equivalent load for radial bearings, while the static axial load in the direction coinciding with the central axis is taken as the static equivalent load for thrust bearings.

Static equivalent load on radial bearings.

The greater of the two values calculated from the following equations should be adopted as the static equivalent load on radial bearings.

$$P_0 = X_0 F_r + Y_0 F_a$$

$$P_0 = F_r$$

Static equivalent load on thrust bearings:

$$P_0 = X_0 F_r + F_a \quad \alpha \neq 90^\circ$$

Table 2.1 Static Equivalent Load $P_0 = X_0 F_r + Y_0 F_a$

Contact Angle	Single DT		DB or DF		where
	X_0	Y_0	X_0	Y_0	
15	0.5	0.46	1	0.92	P_0 : Static equivalent load (N) F_r : Radial load (N) F_a : Axial load (N) X_0 : Static radial load factor Y_0 : Static axial load factor
18	0.5	0.42	1	0.84	
25	0.5	0.38	1	0.76	
30	0.5	0.33	1	0.66	
40	0.5	0.26	1	0.52	

When single or DT mounting and $F_r > 0.5F_r + Y_0 F_a$, use $P_0 = F_r$

Permissible Static Load Factor

The permissible static equivalent load on bearings varies depending on the basic static load rating and also their application and operating conditions.

The permissible static load factor is a safety factor that is applied to the basic static load rating, and it is defined by the ratio in equation below:

$$f_s = (C_0 / P_0)$$

where

C_0 : Basic static load rating (N)

P_0 : Static equivalent load (N)

Table 2.2 Values of Permissible Static Load Factor f_s

Operating conditions	Lower limit of f_s	
	Ball bearings	Roller bearings
Low-noise applications	2.0	3.0
Bearings subjected to vibration and shock loads	1.5	2.0
Standard operating conditions	1.0	1.5

Permissible Axial Loads

In order to optimize bearing performance, NSK has defined the permissible axial loads statistically, based on the following 2 situations:

- The limiting load at which a contact ellipse is generated between the ball and raceway due to a change in the contact angle when a radial bearing, which is under an axial load, rides over the shoulder of the raceway groove.
- The value of a static equivalent load P_0 which is determined from the basic static load rating C_0 using static axial load factor Y_0 .

The permissible axial load is determined by the lower of the two values defined above.

This value has been proven through experience, and includes a safety factor.

(Refer to the bearing tables for permissible axial loads)

Fig. 2.2 Contact Ellipse and the Limiting Axial Loads

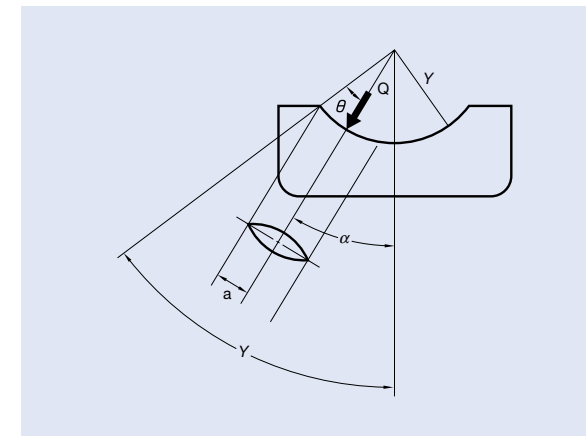

Angular Contact Ball Bearing Combinations Available

Normally, NSK supplies matched super precision angular contact ball bearings as 2, 3, and 4 row combinations. The combinations available for the fixed end of spindles are usually 2 rows (DB), 3 rows (DBD), and 4 rows (DBB) sets. However, in the case of 3 row combinations, since the preload distribution to each bearing is not equal, the optimum preload setting range is very limited, making them unsuitable for high speed applications.

Matched bearings are manufactured as sets, so when they are mounted adjacent to each other, a given preload is automatically obtained. The variation per pair of matched bearings for bore and outer diameters is adjusted to less than 1/3 of the permissible tolerance.

Table 3.1 Features of Each Combination

	DB	DF	DT	DBD	DBB
Load direction	↔	↔	→	↔	↔
Moment stiffness	◎	○	△	◎	◎
Speed capability	◎	◎	◎	△	○
Heat generation	◎	◎	◎	△	○
Stiffness	○	○	△	◎	◎

◎Excellent ◎Very good ○Good △Fair →One direction only ↔Two directions

Features of Each Combination

● Back-to-back Arrangement, DB

Axial loads in both directions and radial loads can be sustained. Since the distance between the effective load centers is large, this type is suitable if moments are applied. However, if accuracy of housing is not enough and there is a misalignment in the spindle, internal loads of bearings could be large enough to possibly cause premature failure due to greater moment stiffness.

● Face-to-face Arrangement, DF

Compared with the DB type, the distance between the effective load centers is small, so the capacity to sustain moments is inferior to the DB type. On the other hand, this type is suitable for using with housings that have less accuracy or larger shaft deflections due to low bending stiffness of shaft.

● Tandem Arrangement, DT

Axial loads in one direction and radial loads can be sustained. Since axial stiffness of this type is twice the value of a single row type, this arrangement is used when the axial load in one direction is heavy.

● 3 rows Arrangement, DBD

Axial loads in both directions and radial loads can be sustained. However, the preload distribution to each bearing is not equal, and preload on the counter side (single side) is twice that of other side. Consequently, this type is unsuitable for high speed operation because of the large increase of internal load of the single side which could lead to bearing failure.

● 4 rows Arrangement, DBB

Axial loads in both directions and radial loads can be sustained. In situations that have the same axial clearance as DB arrangement, preload and stiffness are twice that of the DB arrangement. Also, the permissible axial load of a 4 row arrangement is larger than that of a DB arrangement.

Fig. 3.1 The Distance between the Effective Load Centers of Back-to-back and Face-to-face Arrangements

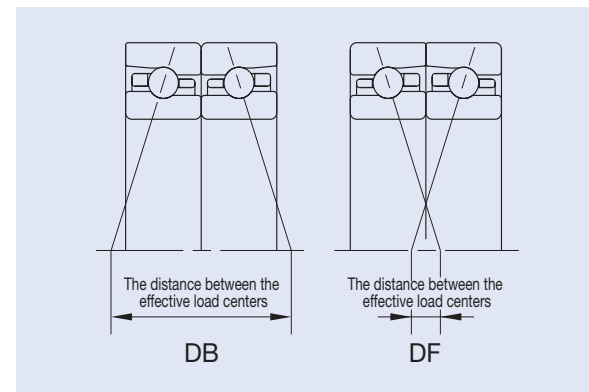

Fig. 3.2 Load Direction in Back-to-Back and Tandem Arrangements

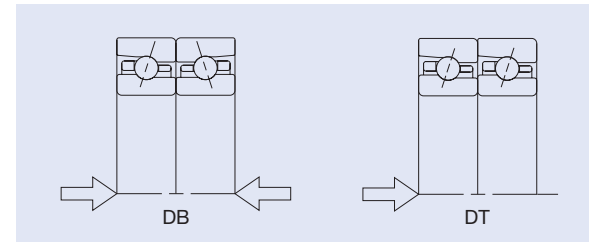
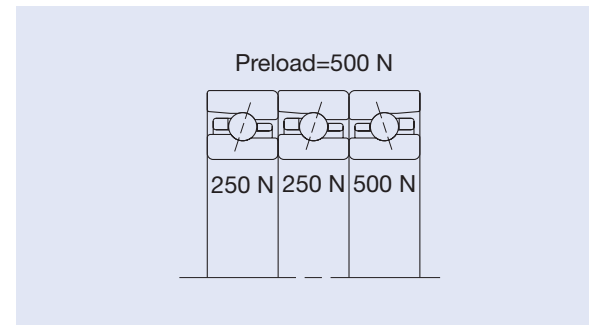

Fig. 3.3 Internal Preload in DBD Arrangement



Shaft Bending Comparison between Back-to-back and Face-to-face Arrangements

Moment stiffness is different between Back-to-back and Face-to-face arrangements as shown in the shaft bending comparison calculation example below. In this example, angular contact ball bearings (75BNR10XET) are used in the front side and the typical shaft deflections are shown for both DB and DF configurations. When 1 000 N of radial load is applied on the spindle nose, radial displacements on the spindle nose are calculated as follows.

$$\sigma_{DB} = 2.4079 \times 10^{-2}$$

$$\sigma_{DF} = 2.9853 \times 10^{-2}$$

This demonstrates the effect of the distance between effective load centers on spindle bending.

Mounting Instructions for Angular Contact Ball Bearings — Matching Method

Direction of Matching

For matched bearings, the mounting order and load application direction are very important.

A “V” is marked on the outer diameter surfaces of the bearings as shown in the figure on the right. When the bearings are mounted so their marks correctly form a “V”, they are properly matched and aligned.

On the side surface or chamfered part of the inner rings, the symbol “○” is marked to indicate the position of maximum radial runout. Optimum accuracy is achieved when the bearing is mounted so the “○” symbol is placed just opposite the position of shaft maximum eccentricity.

Fig. 3.5 The Symbol for the Position of Maximum Radial Runout of Inner Ring

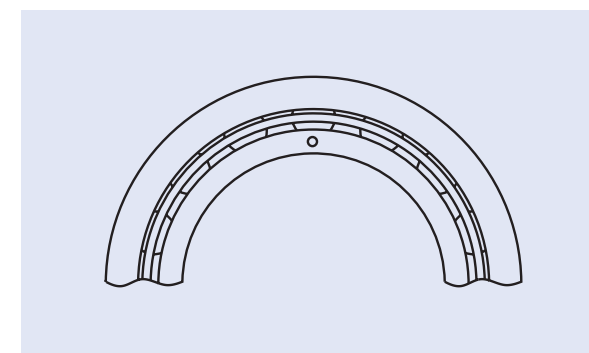

Fig. 3.4 Spindle Displacement Curve

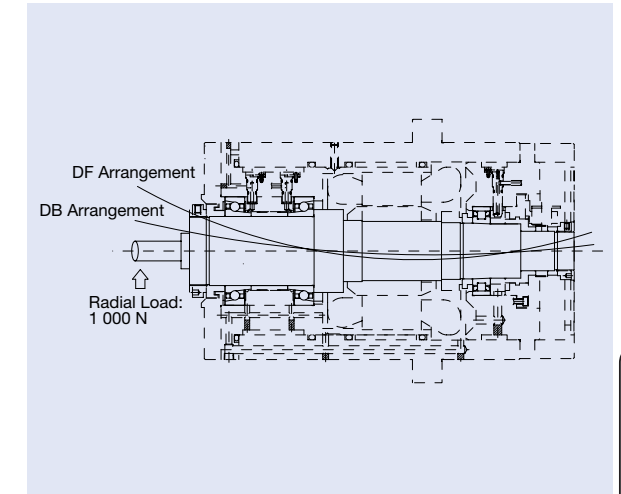
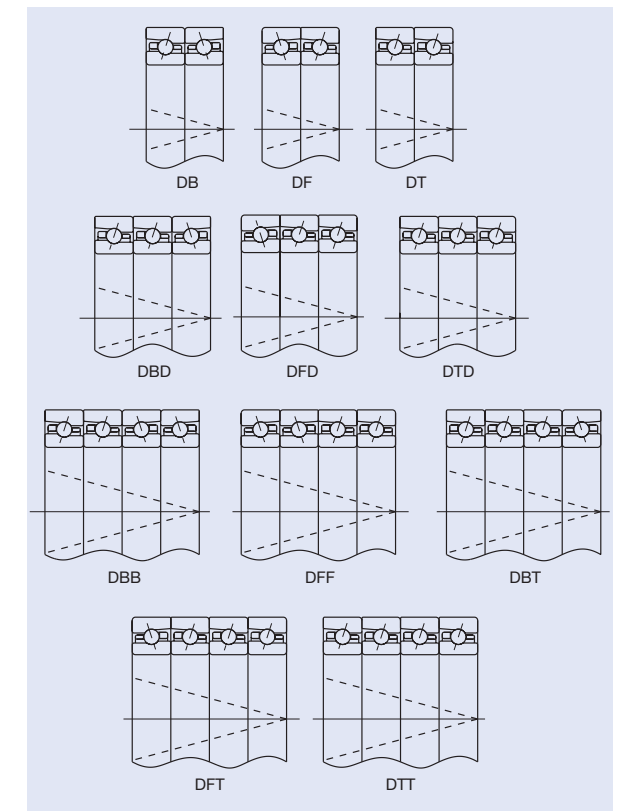

Fig. 3.6 Combinations of Angular Contact Ball Bearings



Universal Combination

NSK supplies universal combination angular contact ball bearings that have the same amount stand out on both the front and back face. This means that when bearings that have the same reference number are combined, they have the specified amount for each standard preload.

For universal combination bearings, the “V” combination marks on the outer diameter surface of outer ring prevent “direction” mistakes, ensure correct matching when they are mounted, and indicate the direction of the contact angle.

Fig. 3.7 Universal Combination

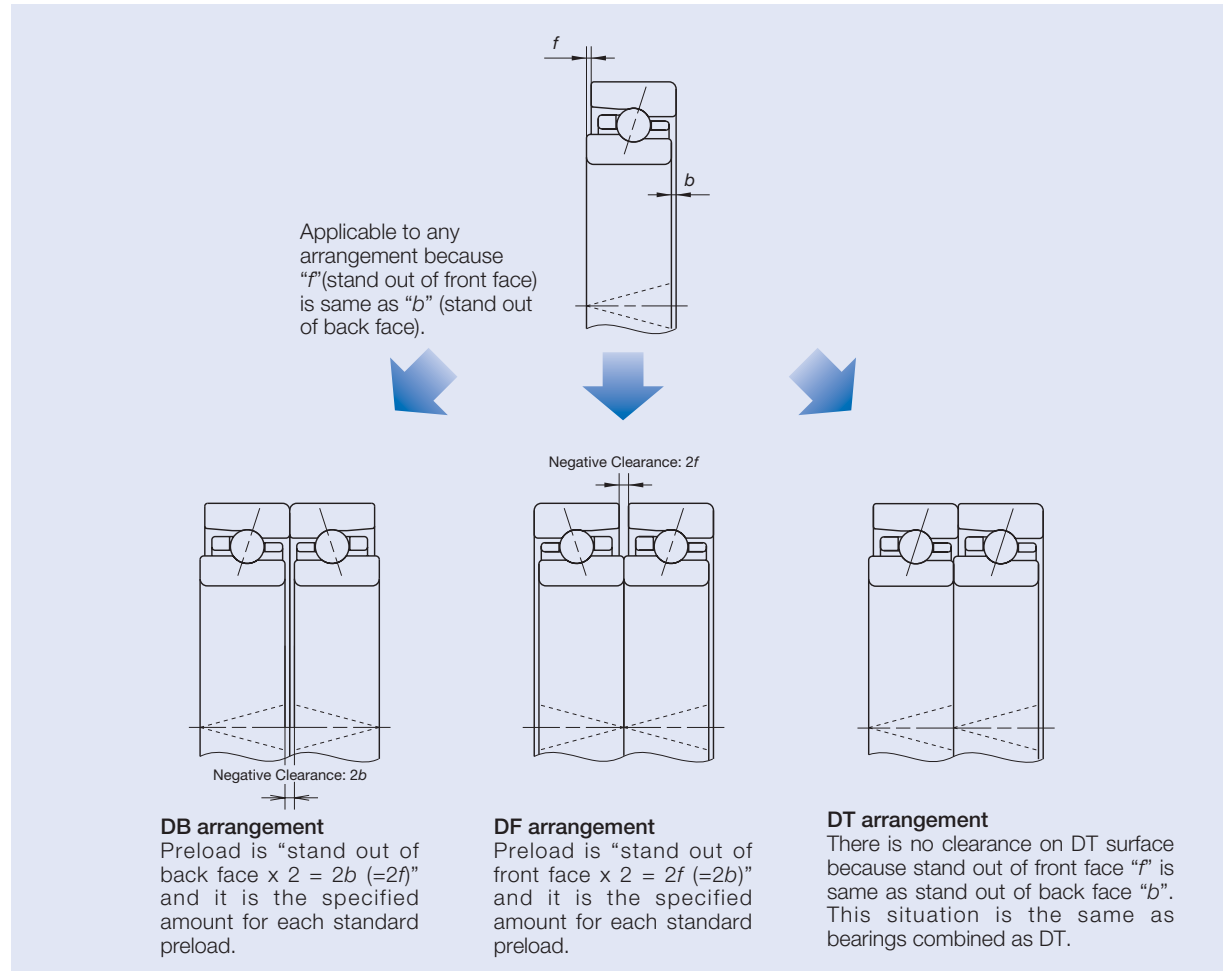

Difference between SU and DU Bearings

There are 2 types of NSK universal combination bearings as shown in the table below.

Table 3.2 Features of SU and DU Bearings

	SU	DU
Row of bearings	1	2
Variation of bore and outer diameter tolerance	-	Controlled in 1/3 of tolerance

Notice for Use of Single Universal (SU) Bearings

- When these bearings are used as part of multiple combined bearings, it is recommended that the variation of bore and outer diameter tolerance is within 1/3 of tolerance range.
- There are also special bearings with special accuracy “Class 4Y” that can accommodate small variations of bore and outer diameter tolerance. “Class 4Y” tolerance has the same running accuracy as Class 4 but has a narrower tolerance range of bore and outer diameter than Class 4. It is suitable for “random matching method” universal combination bearings.
- “Class 4Y” is suitable for use “random matching method” universal combination bearings. However, when these bearings are operated over 1 500 000 $d_m n$, there is a possibility that this very small variation of fits with either the shaft or the housing can cause bearing failure because of imbalance of internal load in each row. If these bearings are considered for such high speed applications, this issue should be taken into account.

Fig. 3.8 Tolerance of P4 and P4Y Accuracy

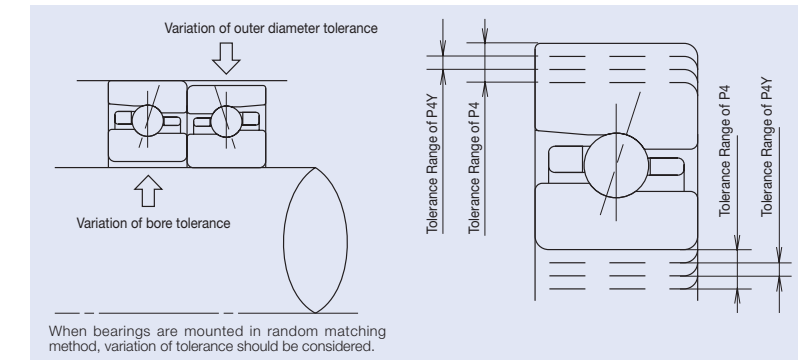

Combination Mark and Matching Method for Universal Combination Bearings

Fig. 3.9 Universal Bearings Combinations

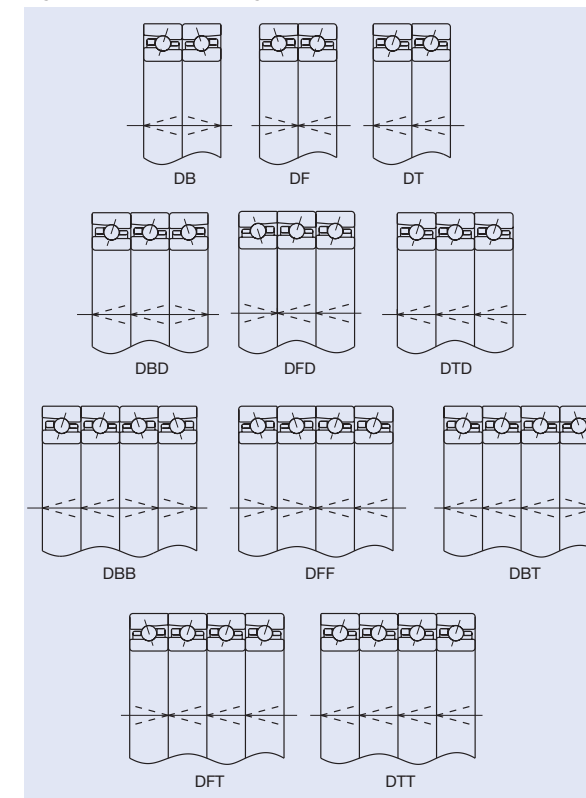

Bore and Outer Diameter Tolerance (Class 4Y)

Table 3.3 Tolerance of Bore Diameter of Inner Ring Unit: μm

Bore diameter	Class 4	Class 4Y (Controlled to medium value)	
		High	Low
Over 30	Incl 50	0	-6
50	80	0	-7
80	120	0	-8
120	150	0	-10

*Tolerances for bearings under 30 mm bore are the same as values quoted between 30–50 mm bore.

Table 3.4 Tolerance of Outer Diameter of Outer Ring Unit: μm

Outer diameter	Class 4	Class 4Y (Controlled to medium value)	
		High	Low
Over 50	Incl 80	0	-7
80	120	0	-8
120	150	0	-9
150	180	0	-10
180	200	0	-11
200	Under 215	0	-11

*Tolerances for bearings under 50 mm outer diameter are the same as values quoted between 50–80 mm outer diameter.

Regarding the rigidity of machine tool spindles, it is possible to think of the bearings as being springs. Axial displacement, when an axial load is applied to the spindle, is determined by the axial rigidity of the fixed end bearings.

When high radial rigidity is required, cylindrical roller bearings are generally used. Axial loads are usually sustained by angular contact ball bearings. The bigger the contact angle of the angular contact ball bearings, the higher the axial rigidity. Bearings of the same bore size, which have more rolling elements (diameter series 0 or 9; or BNR10 or BNR19 series), have higher rigidity, even though the diameter or the rolling elements is smaller.

Normally, preload is applied to bearings in order to increase rigidity of machine tool spindles. But if the preload is excessively high, flaking and possible seizure will result. Many users increase rigidity by using a combination of two or more angular contact ball bearings. This is especially true for ball screw support bearings, where high rigidity is required, the contact angle is big, and preload is higher than that for a spindle. Axial loads are widely sustained with two or three bearings.

Purpose

The main purposes of preloaded bearings in a machine tool spindle are as follows:

- To improve and maintain the running accuracy of the shaft.
- To increase bearing rigidity.
- To minimize noise due to axial vibration and resonance.
- To prevent false brinelling.
- To prevent sliding between the rolling elements and raceways due to gyroscopic moments.
- To maintain the rolling elements in their proper position.

Usually a preload is applied to bearings by using two or more bearings in combination with each other, such as angular contact ball bearings or tapered roller bearings.

Cylindrical roller bearings can be preloaded by making the radial internal clearance negative.

(1) Position Preload

A position preload is achieved by fixing two axially opposed bearings in a position that remains unchanged while in operation. In practice, the following three methods are generally used to obtain a position preload.

1. By installing a duplex bearing set with previously adjusted stand-out dimensions and axial clearance
2. By using a spacer or shim of proper size to obtain the required spacing and preload (see Fig. 4.1).
3. By utilizing bolts or nuts to allow adjustment of the axial preload (In this case, the starting torque should be measured to verify the proper preload. However, this method cannot be recommended for high precision machine tool spindles due to difficulty in verifying the proper

preload, thus risking vertical displacement (tilting) of the bearing.)

Fig. 4.1 Position Preload

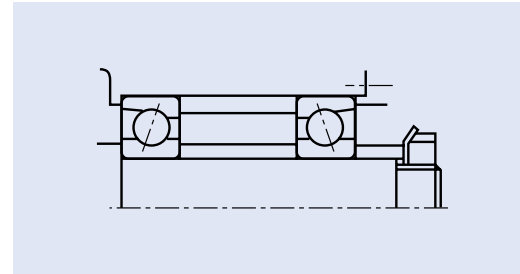

(2) Constant Pressure Preload

A constant pressure preload is achieved using a coil or leaf spring.

Even if the relative position of the bearings change during operation, the magnitude of the preload remains relatively constant. An angular contact ball bearing arrangement for high speed rotation is shown in Fig. 4.2.

Fig. 4.2 Constant Pressure Preload

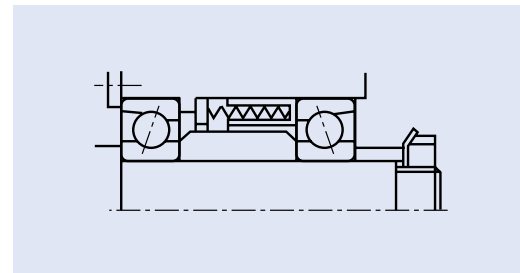

Change of Rigidity by Preload

Position Preload and Axial Rigidity

When the inner rings of the duplex bearings shown in Fig. 4.3 are fixed axially, bearings A and B are displaced δ_{aoA} and δ_{aoB} and axial space δ_{ao} between the inner rings is eliminated. With this condition, a preload F_{ao} is imposed on each bearing. The relation between axial load, F_a and displacement in a duplex set is shown in Fig. 4.4. Figures 4.5 and 4.6 illustrate the same concepts for a DBD arrangement.

Back-to-Back Arrangement (DB)

Fig. 4.3 Preloaded DB Arrangement

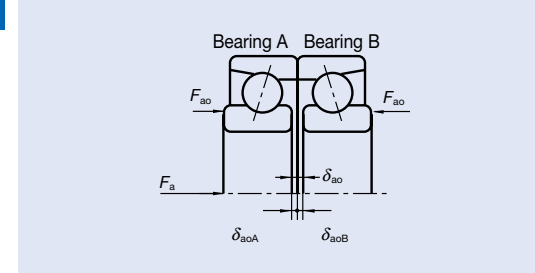
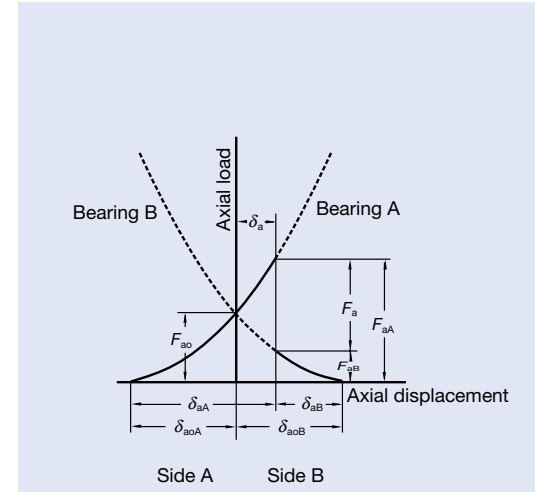

Fig. 4.4 Preloaded Axial Displacement of DB Arrangement



- F_a : Axial load applied from outside
- F_{aA} : Axial load imposed on Bearing A
- F_{aB} : Axial load imposed on Bearing B
- δ_a : Displacement of duplex set
- δ_{aA} : Displacement of Bearing A
- δ_{aB} : Displacement of Bearing B

DBD Arrangement

Fig. 4.5 Preloaded DBD Arrangement

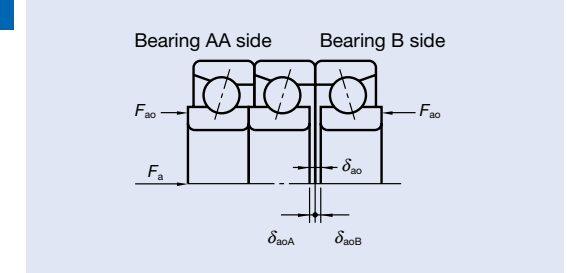
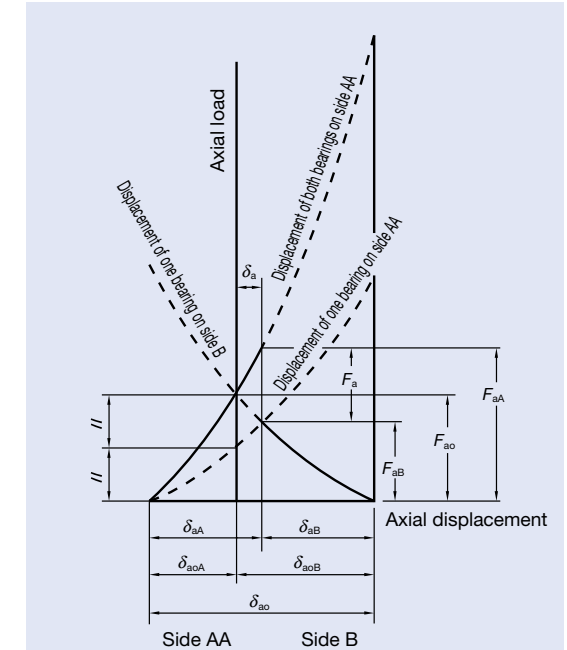

Fig. 4.6 Preloaded Axial Displacement of DBD Arrangement



- F_a : Axial load applied from outside
- F_{aA} : Axial load imposed on Bearing AA
- F_{aB} : Axial load imposed on Bearing B
- δ_a : Displacement of triplex set
- δ_{aA} : Displacement of Bearing AA
- δ_{aB} : Displacement of Bearing B

Constant Pressure Preload and Axial Rigidity

Fig. 4.7 illustrates duplex bearing under constant pressure preload. The deflection curve of the spring is nearly parallel to the horizontal axis due to the rigidity of the springs being smaller than that of the bearing. As a result, rigidity under constant pressure preload is approximately equal to that for a single bearing with a preload of F_{a0} being applied to it.

Fig. 4.8 compares the rigidity of a bearing with position preloading and one with constant pressure preloading.

Fig. 4.7 Axial Displacement with Constant Pressure Preload

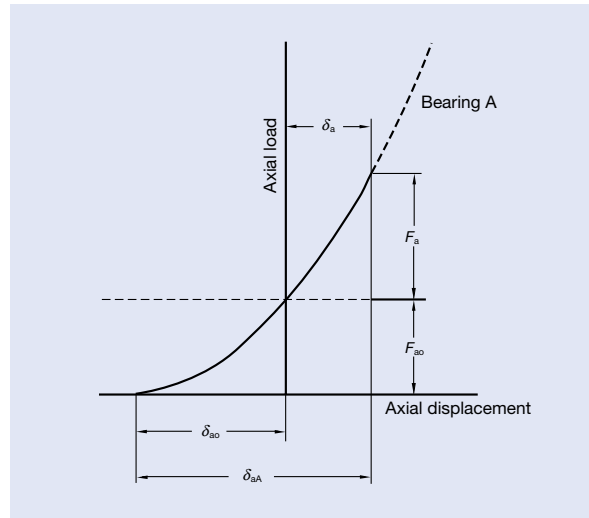
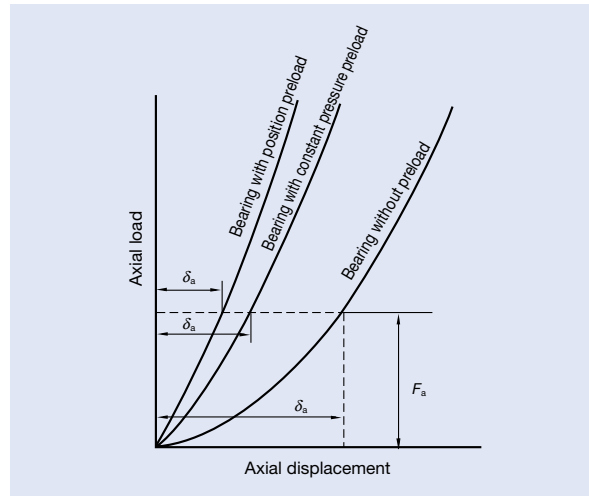

Fig. 4.8 Comparison of Stiffness and Preloading



Comparison of Preloading Methods

Position preload and constant pressure preload can be compared as follows:

- (1) When both of the preloads are equal, the position preload provides greater bearing rigidity. In other words, the deflection due to external loads is less for bearings with a position preload.
- (2) Under position preload, the preload varies depending on such factors as a difference in axial expansion due to a temperature difference between the shaft and housing, a difference in radial expansion due to a temperature difference between the inner and outer rings, and deflection due to load. Under constant pressure preload, it is possible to minimize any change in preload because the variation of the spring load with shaft expansion and contraction is negligible.

From the foregoing explanation, it is seen that position preloads are generally preferred for increasing rigidity while constant pressure preloads are more suitable for high speed applications.

Preload Amount

A larger preload results in higher rigidity. However, if preload is larger than necessary, abnormal heat is generated, which reduces fatigue life. In extreme cases, it may result in excessive wear or even seizure. Therefore, the amount of preload should be carefully studied and selected to avoid excessive preload while taking into consideration the type of application and the operating conditions.

High Speed Spindles and Preload

When bearings operate at high speed, the contact surface pressure between the balls and the inner and outer ring raceways increases due to expansion of the internal axial load caused by centrifugal force, generation of internal axial load caused by centrifugal force on the balls, and temperature difference between inner and outer rings. For bearings having a contact angle, such as angular contact ball bearings, pure rolling motion with sliding due to spin moments and gyroscopic moments on the balls may occur.

Sliding increases as bearing speed increases. As a result, the intensity of heat generated in the contact areas increases and the viscosity of the lubricating oil decreases. In some cases, a breakdown of the oil film occurs, resulting in complete seizure of the bearing. In other words, if the contact surface pressure at low speed operation is equal to that of high speed operation, then heat generation, which is due to sliding at high speeds, becomes more intense. This concept can be expressed quantitatively as a Pv value, where P is the contact surface pressure, and v is the slip rate. The Pv value can be applied to the rolling contact area of the bearing. If the Pv value is constant, sliding is greater at high speed operation than at low speed operation. Whereas velocity is increased, it

becomes necessary to reduce the contact surface pressure. NSK can calculate contact surface pressure and slip rate generated during high speed operations by computer. Taking advantage of abundant empirical test data and actual market results, we can determine the preload according to limiting factors, which are based on the lubricating method and rotating speed. For operations exceeding $800\,000\ d_{m}n$, please contact NSK.

Special Clearance

For special clearance of combined angular contact ball bearings, NSK offers both CA and CP clearances.

CA: axial clearance (Clearance exists in the axial direction)

CP: preload clearance (Preload is generated)

Fig. 4.9 Special Clearance

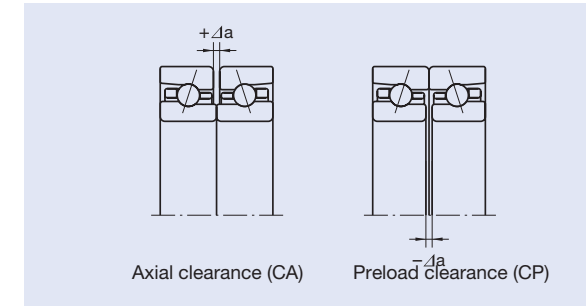

Preload Adjustment

When you change preload (for example "EL→L"), please adjust the difference of the measured axial clearance, by a spacer. (When increasing preload, inner spacer should be shorter, and outer spacer should be shorter when decreasing preload) Please refer to Pages 156–166 of the measured axial clearances.

Please refer the measuring load of axial clearance to Table 4.1.

Table 4.1 Measuring load of axial clearance

Nominal Outside Diameter (mm)		Measuring load (N)
Over	Incl	
10*	50	24.5
50	120	49
120	200	98
200	—	196

* Applied to the bearing with the O. D. less than 10 mm.

Fig. 4.10 Radial Clearance in Double Row Cylindrical Roller Bearing and Variation of Rolling Fatigue Life

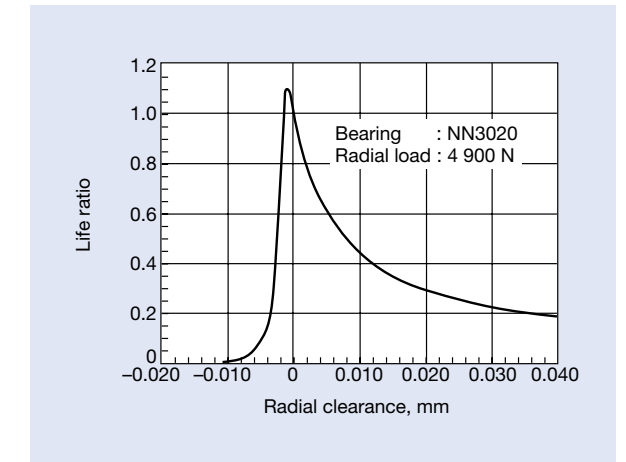
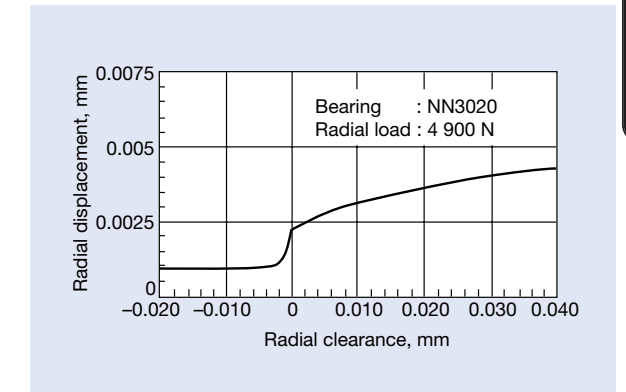

Fig. 4.11 Radial Clearance in Double Row Cylindrical Roller Bearing and Variation of Rigidity



Internal Clearance in Cylindrical Roller Bearings

In order for machine tool spindles to have high running accuracy and rigidity, bearings are used with minimum internal clearance or preload after mounted. Cylindrical roller bearings with tapered bores are usually used to allow easier adjustment of internal clearance. In general, cylindrical roller bearings for the front end (fixed end) of the spindle are adjusted to apply a preload during operating. Bearing for the rear end (free end) are adjusted when mounted to produce a slight clearance during operating. The amount of radial internal clearance after mounted is based on several factors such speed, load, lubricating method, bearing size, required rigidity, life, etc.

Fig. 4.10 illustrates the relation between radial internal clearance in a bearing and life. Fig. 4.11 shows the relation between radial internal clearance and radial elastic displacement of an NN3020 (Bore diameter 100 mm, outside diameter 150 mm, width 37 mm).

4. PRELOAD AND RIGIDITY

Preload and Rigidity (DB and DF Arrangement)

High Precision Angular Contact Ball Bearings

(Standard series)

Calculation of radial rigidity
Multiply axial rigidity by factors
in table A.

	EL	L	M	H
15°	6.5	6.0	5.0	4.5
18°		4.5		
25°		2.0		
30°		1.4		
40°	0.7			

Calculation of preload and axial rigidity for combination bearings
Multiply by factors in table B.
For radial rigidity, multiply the value obtained in table A with factors in table B.

	DBD	DBB
Preload factor	1.36	2
Axial rigidity	1.48	2
Radial rigidity	1.54	2

79 series, C angle

Nominal contact angle 15° Steel ball and Ceramic ball*

Bore Number	Nominal Bearing Bore (mm)	EL		L		M		H					
		Preload (N)	Axial Rigidity (N/μm)	Preload (N)	Axial Rigidity (N/μm)	Preload (N)	Axial Rigidity (N/μm)	Preload (N)	Axial Rigidity (N/μm)				
00	10	7	(5)	10	15	(2)	14	29	(-1)	19	59	(-6)	27
01	12	8.6	(4)	12	15	(2)	16	39	(-3)	24	78	(-8)	34
02	15	12	(3)	14	25	(0)	20	49	(-4)	26	100	(-11)	38
03	17	12	(3)	15	25	(0)	20	59	(-5)	30	120	(-12)	43
04	20	19	(1)	19	39	(-3)	26	78	(-8)	35	150	(-15)	48
05	25	19	(1)	21	39	(-2)	28	100	(-9)	43	200	(-17)	61
06	30	24	(0)	25	49	(-3)	33	100	(-9)	45	200	(-16)	65
07	35	34	(2)	29	69	(-2)	39	150	(-9)	55	290	(-18)	78
08	40	39	(1)	32	78	(-3)	42	200	(-12)	63	390	(-22)	88
09	45	50	(0)	37	100	(-5)	50	200	(-12)	66	390	(-21)	94
10	50	50	(0)	39	100	(-4)	51	250	(-14)	78	490	(-24)	111
11	55	60	(-1)	45	120	(-6)	58	290	(-15)	90	590	(-26)	127
12	60	60	(-1)	46	120	(-5)	60	290	(-14)	93	590	(-25)	128
13	65	75	(-2)	53	150	(-7)	71	340	(-16)	104	690	(-27)	146
14	70	100	(-4)	59	200	(-10)	79	490	(-22)	119	980	(-35)	168
15	75	100	(-4)	61	200	(-10)	88	490	(-21)	120	980	(-35)	171
16	80	100	(-4)	62	200	(-9)	80	490	(-21)	124	980	(-34)	173
17	85	145	(-6)	73	290	(-13)	97	640	(-25)	138	1 270	(-41)	191
18	90	145	(-3)	79	290	(-9)	102	740	(-23)	156	1 470	(-39)	219
19	95	145	(-3)	81	290	(-9)	105	780	(-24)	165	1 570	(-40)	231
20	100	195	(-5)	83	390	(-13)	112	880	(-27)	164	1 770	(-46)	231
21	105	195	(-5)	86	390	(-13)	116	880	(-27)	167	1 770	(-45)	235
22	110	195	(-5)	89	390	(-13)	120	930	(-27)	173	1 860	(-45)	244
24	120	270	(-8)	102	540	(-17)	135	1 270	(-35)	200	2 550	(-56)	278
26	130	320	(-10)	108	640	(-20)	148	1 470	(-38)	214	2 940	(-61)	302
28	140	320	(-10)	111	640	(-19)	150	1 470	(-37)	218	2 940	(-60)	309
30	150	395	(-7)	124	790	(-18)	166	1 790	(-38)	239	3 560	(-63)	334
32	160	425	(-8)	134	855	(-19)	179	1 930	(-39)	258	3 840	(-64)	361
34	170	485	(-9)	151	970	(-20)	200	2 180	(-40)	288	4 310	(-65)	403
36	180	595	(-12)	158	1 190	(-25)	211	2 650	(-48)	302	5 340	(-78)	425
38	190	605	(-12)	162	1 210	(-25)	217	2 790	(-49)	315	5 600	(-79)	443
40	200	785	(-16)	183	1 570	(-31)	244	3 570	(-58)	352	7 110	(-92)	493

79 series, A5 angle

Nominal contact angle 25° Steel ball and Ceramic ball*

Bore Number	Nominal Bearing Bore (mm)	EL		L		M		H					
		Preload (N)	Axial Rigidity (N/μm)	Preload (N)	Axial Rigidity (N/μm)	Preload (N)	Axial Rigidity (N/μm)	Preload (N)	Axial Rigidity (N/μm)				
00	10	9.8	(2)	24	20	(1)	31	49	(-3)	44	100	(-6)	59
01	12	16	(1)	32	29	(-1)	40	59	(-3)	52	120	(-7)	70
02	15	16	(1)	33	39	(-1)	46	78	(-4)	60	150	(-9)	78
03	17	19	(1)	34	39	(-1)	46	78	(-4)	62	150	(-8)	81
04	20	29	(0)	43	59	(-3)	60	120	(-6)	75	250	(-12)	103
05	25	34	(-1)	56	69	(-3)	70	150	(-7)	95	290	(-12)	123
06	30	39	(-1)	61	78	(-3)	77	150	(-6)	99	290	(-11)	131
07	35	50	(0)	70	100	(-3)	94	250	(-8)	127	490	(-15)	170
08	40	60	(-1)	72	120	(-3)	97	290	(-9)	139	590	(-16)	182
09	45	75	(-1)	87	150	(-4)	114	340	(-10)	160	690	(-17)	207
10	50	75	(-1)	94	150	(-4)	124	390	(-10)	175	780	(-18)	235
11	55	100	(-2)	112	200	(-5)	144	440	(-11)	198	880	(-18)	263
12	60	100	(-2)	117	200	(-5)	150	440	(-10)	198	880	(-18)	267
13	65	100	(-2)	125	200	(-5)	161	490	(-11)	223	980	(-18)	289
14	70	145	(-3)	138	290	(-7)	183	690	(-14)	249	1 370	(-24)	334
15	75	145	(-3)	142	290	(-7)	188	740	(-15)	267	1 470	(-24)	347
16	80	170	(-4)	156	340	(-8)	203	780	(-15)	274	1 570	(-25)	367
17	85	220	(-5)	172	440	(-9)	229	980	(-17)	306	1 960	(-29)	402
18	90	245	(-4)	188	490	(-8)	253	1 080	(-16)	340	2 160	(-27)	449
19	95	245	(-3)	195	490	(-8)	262	1 180	(-17)	363	2 350	(-28)	475
20	100	295	(-5)	197	590	(-10)	266	1 270	(-19)	346	2 550	(-31)	463
21	105	295	(-4)	203	590	(-9)	264	1 370	(-19)	368	2 750	(-32)	490
22	110	320	(-5)	222	640	(-10)	284	1 470	(-20)	391	2 940	(-33)	517
24	120	440	(-7)	244	880	(-13)	328	1 960	(-24)	441	3 920	(-39)	580
26	130	490	(-7)	262	980	(-14)	346	2 160	(-25)	460	4 310	(-41)	611
28	140	490	(-7)	273	980	(-13)	348	2 260	(-26)	479	4 510	(-42)	635
30	150	625	(-7)	308	1 250	(-14)	393	2 880	(-28)	540	5 860	(-47)	719
32	160	665	(-7)	330	1 330	(-14)	422	3 230	(-29)	592	6 290	(-47)	775
34	170	775	(-8)	376	1 550	(-15)	478	3 520	(-29)	653	7 110	(-48)	867
36	180	1 010	(-10)	397	2 020	(-19)	514	4 420	(-35)	693	8 830	(-57)	917
38	190	1 035	(-10)	409	2 070	(-19)	531	4 550	(-35)	717	9 110	(-57)	949
40	200	1 280	(-12)	453	2 560	(-22)	585	5 840	(-41)	801	11 620	(-66)	1 057

70 series, C angle

Nominal contact angle 15° Steel ball and Ceramic ball*

Bore Number	Nominal Bearing Bore (mm)	EL		L		M		H					
		Preload (N)	Axial Rigidity (N/μm)	Preload (N)	Axial Rigidity (N/μm)	Preload (N)	Axial Rigidity (N/μm)	Preload (N)	Axial Rigidity (N/μm)				
00	10	12	(3)	12	25	(0)	17	49	(-5)	23	100	(-12)	32
01	12	12	(3)	14	25	(0)	18	59	(-6)	26	120	(-14)	37
02	15	14	(3)	16	29	(-1)	20	69	(-7)	29	150	(-16)	43
03	17	14	(2)	16	29	(-1)	21	69	(-7)	31	150	(-16)	45
04	20	24	(0)	21	49	(-4)	28	120	(-12)	42	250	(-22)	59
05	25	29	(-1)	24	59	(-5)	32	150	(-14)	48	290	(-24)	68
06	30	39	(1)	29	78	(-3)	39	200	(-13)	59	390	(-24)	83
07	35	60	(-1)	36	120	(-7)	49	250	(-16)	68	490	(-28)	94
08	40	60	(-1)	39	120	(-6)	51	290	(-17)	77	590	(-30)	110
09	45	75	(-3)	43	150	(-8)	58	340	(-19)	85	690	(-33)	121
10	50	75	(-2)	46	150	(-8)	63	390	(-20)	96	780	(-34)	136
11	55	100	(-4)	51	200	(-11)	69	490	(-24)	102	980	(-40)	145
12	60	100	(-4)	53	200	(-11)	70	540	(-26)	110	1 080	(-42)	158
13	65	125	(-6)	61	250	(-13)	82	540	(-24)	117	1 080	(-39)	164
14	70	145	(-7)	68	290	(-14)	88	740	(-30)	135	1 470	(-48)	190
15	75	145	(-7)	70	290	(-14)	92	780	(-31)	144	1 570	(-49)	202
16	80	195	(-6)	76	390	(-14)	103	930	(-31)	152	1 860	(-52)	216
17	85	195	(-6)	78	390	(-14)	106	980	(-32)	161	1 960	(-52)	225
18	90	245	(-8)	87	490	(-18)	117	1 180	(-37)	172	2 350	(-60)	242
19	95	270	(-9)	93	540	(-19)	124	1 180	(-36)	176	2 350	(-58)	246
20	100	270	(-9)	97	540	(-18)	127	1 270	(-37)	187	2 550	(-60)	264
21	105	320	(-11)	103	640	(-21)	134	1 470	(-42)	198	2 940	(-67)	277
22	110	370	(-13)	104	740	(-25)	137	1 770	(-49)	203	3 530	(-78)	286
24	120	415	(-14)	116	830	(-26)	153	1 960	(-50)	225	3 920	(-79)	317
26	130	490	(-16)	126	980	(-29)	167	2 260	(-54)	244	4 510	(-85)	344
28	140	500	(-11)	132	1 000	(-24)	174	2 210	(-47)	248	4 420	(-77)	349
30	150	575	(-13)	141	1 150	(-27)	187	2 560	(-52)	267	5 100	(-84)	374
32	160	625	(-14)	147	1 250	(-29)	197	2 930	(-57)	288	5 840	(-90)	403
34	170	780	(-18)	160	1 560	(-35)	213	3 560	(-66)	309	7		

4. PRELOAD AND RIGIDITY

Preload and Rigidity (DB and DF Arrangement)

High Precision Angular Contact Ball Bearings

(Standard series)

Calculation of radial rigidity
Multiply axial rigidity by factors
in table A.

	EL	L	M	H
15°	6.5	6.0	5.0	4.5
18°		4.5		
25°		2.0		
30°		1.4		
40°	0.7			

Calculation of preload and axial
rigidity for combination bearings
Multiply by factors in table B.
For radial rigidity, multiply the value
obtained in table A with factors in
table B.

	DBD	DBB
Preload factor	1.36	2
Axial rigidity	1.48	2
Radial rigidity	1.54	2

70 series, A angle

Nominal contact angle 30° Steel ball

Bore Number	Nominal Bearing Bore (mm)	EL		L		M		H	
		Preload (N)	Axial Rigidity (N/μm)	Preload (N)	Axial Rigidity (N/μm)	Preload (N)	Axial Rigidity (N/μm)	Preload (N)	Axial Rigidity (N/μm)
00	10	25	(0) 44	100	(-5) 71	210	(-10) 94	330	(-15) 115
01	12	25	(0) 48	110	(-5) 78	220	(-10) 104	360	(-15) 127
02	15	25	(0) 50	110	(-5) 85	240	(-10) 113	390	(-15) 139
03	17	25	(0) 52	120	(-5) 91	250	(-10) 122	420	(-15) 151
04	20	25	(0) 58	130	(-5) 103	280	(-10) 139	470	(-15) 170
05	25	25	(0) 61	140	(-5) 111	290	(-10) 149	510	(-15) 183
06	30	50	(0) 85	190	(-5) 138	390	(-10) 180	640	(-15) 217
07	35	50	(0) 92	210	(-5) 150	420	(-10) 196	700	(-15) 237
08	40	50	(0) 100	220	(-5) 168	460	(-10) 220	760	(-15) 267
09	45	50	(0) 103	230	(-5) 175	480	(-10) 230	1 180	(-20) 324
10	50	50	(0) 110	250	(-5) 194	530	(-10) 255	1 270	(-20) 360
11	55	50	(0) 112	250	(-5) 196	880	(-15) 311	1 270	(-20) 360
12	60	50	(0) 116	250	(-5) 205	930	(-15) 327	1 370	(-20) 380
13	65	50	(0) 124	270	(-5) 224	980	(-15) 360	1 470	(-20) 417
14	70	50	(0) 127	270	(-5) 230	1 080	(-16) 370	2 060	(-25) 482
15	75	50	(0) 131	280	(-5) 241	1 080	(-15) 387	2 160	(-25) 505
16	80	100	(0) 168	760	(-10) 340	1 770	(-20) 464	3 040	(-30) 572
17	85	100	(0) 173	780	(-10) 355	1 860	(-20) 486	3 240	(-30) 600
18	90	100	(0) 174	780	(-10) 358	2 450	(-25) 542	3 920	(-35) 650
19	95	100	(0) 180	810	(-10) 372	2 550	(-25) 568	4 120	(-35) 680
20	100	100	(0) 185	840	(-10) 368	2 750	(-25) 595	4 310	(-35) 713
21	105	100	(0) 185	840	(-10) 388	2 750	(-25) 591	4 310	(-35) 707
22	110	100	(0) 180	1 320	(-15) 443	3 330	(-30) 620	5 980	(-45) 774
24	120	100	(0) 193	1 470	(-15) 486	3 630	(-30) 683	6 570	(-45) 853
26	130	100	(0) 200	1 470	(-15) 507	4 710	(-35) 772	7 940	(-50) 942
28	140	200	(0) 206	1 770	(-15) 557	5 300	(-35) 828	8 730	(-50) 1 005
30	150	200	(0) 256	1 830	(-15) 573	5 850	(-37) 876	11 700	(-60) 1 146
32	160	200	(0) 260	1 880	(-15) 591	5 545	(-35) 870	12 070	(-60) 1 143
34	170	200	(0) 262	2 669	(-20) 669	6 024	(-37) 899	12 048	(-60) 1 178
36	180	200	(0) 273	3 580	(-24) 778	7 157	(-40) 1 001	14 314	(-64) 1 311
38	190	200	(0) 276	3 851	(-25) 809	8 081	(-43) 1 060	16 162	(-69) 1 389
40	200	200	(0) 279	5 012	(-30) 902	13 314	(-60) 1 294	26 628	(-95) 1 708

The value in () shows a measured axial clearance.

72 series, C angle

Nominal contact angle 15° Steel ball

Bore Number	Nominal Bearing Bore (mm)	EL		L		M		H	
		Preload (N)	Axial Rigidity (N/μm)	Preload (N)	Axial Rigidity (N/μm)	Preload (N)	Axial Rigidity (N/μm)	Preload (N)	Axial Rigidity (N/μm)
00	10	14	(3) 13	29	(-1) 18	69	(-8) 27	150	(-18) 38
01	12	19	(1) 16	39	(-3) 21	100	(-12) 33	200	(-22) 46
02	15	19	(1) 17	39	(-3) 23	100	(-11) 34	200	(-21) 48
03	17	24	(0) 19	49	(-4) 25	150	(-16) 42	290	(-28) 59
04	20	34	(-2) 23	69	(-7) 30	200	(-20) 49	390	(-33) 70
05	25	39	(1) 26	78	(-4) 36	200	(-15) 53	390	(-26) 76
06	30	60	(-1) 32	120	(-8) 43	290	(-20) 66	590	(-35) 94
07	35	75	(-3) 37	150	(-10) 50	390	(-25) 75	780	(-43) 108
08	40	100	(-5) 44	200	(-13) 60	490	(-29) 90	980	(-47) 126
09	45	125	(-7) 49	250	(-16) 67	540	(-30) 94	1 080	(-49) 132
10	50	125	(-7) 52	250	(-15) 69	590	(-31) 102	1 180	(-50) 143
11	55	145	(-8) 56	290	(-17) 74	780	(-38) 117	1 570	(-60) 163
12	60	195	(-11) 64	390	(-22) 86	930	(-42) 126	1 860	(-67) 179
13	65	220	(-12) 71	440	(-23) 95	1 080	(-44) 141	2 160	(-70) 200
14	70	245	(-9) 75	490	(-20) 100	1 180	(-43) 148	2 350	(-69) 210
15	75	270	(-10) 81	540	(-21) 108	1 230	(-42) 157	2 450	(-68) 220
16	80	295	(-12) 83	590	(-24) 109	1 370	(-47) 159	2 750	(-76) 224
17	85	345	(-14) 88	690	(-27) 120	1 670	(-53) 177	3 330	(-85) 251
18	90	390	(-15) 97	780	(-29) 126	1 860	(-57) 187	3 730	(-90) 263
19	95	440	(-18) 98	880	(-33) 130	2 060	(-63) 192	4 120	(-99) 271
20	100	490	(-20) 101	980	(-36) 137	2 350	(-68) 202	4 710	(-107) 285
21	105	540	(-21) 108	1 080	(-38) 144	2 650	(-73) 216	5 300	(-114) 305
22	110	635	(-24) 117	1 270	(-43) 156	2 940	(-78) 228	5 880	(-121) 321
24	120	700	(-19) 128	1 400	(-38) 170	3 210	(-73) 247	6 350	(-116) 345
26	130	760	(-20) 138	1 520	(-39) 183	3 400	(-73) 262	6 740	(-116) 367
28	140	925	(-24) 152	1 850	(-45) 202	4 110	(-82) 288	8 300	(-131) 406
30	150	1 110	(-28) 167	2 220	(-51) 222	4 960	(-92) 318	9 970	(-145) 447

72 series, A5 angle

Nominal contact angle 25° Steel ball

Bore Number	Nominal Bearing Bore (mm)	EL		L		M		H	
		Preload (N)	Axial Rigidity (N/μm)	Preload (N)	Axial Rigidity (N/μm)	Preload (N)	Axial Rigidity (N/μm)	Preload (N)	Axial Rigidity (N/μm)
00	10	19	(1) 29	39	(-2) 41	100	(-7) 58	200	(-13) 73
01	12	29	(-1) 36	59	(-3) 49	150	(-9) 70	290	(-16) 92
02	15	34	(-1) 43	69	(-4) 57	200	(-11) 83	390	(-19) 111
03	17	39	(-1) 46	78	(-4) 60	200	(-11) 87	390	(-18) 116
04	20	60	(-3) 59	120	(-6) 73	290	(-14) 104	590	(-24) 140
05	25	75	(-2) 68	150	(-5) 90	340	(-12) 124	690	(-22) 167
06	30	100	(-3) 85	200	(-7) 107	440	(-15) 147	880	(-25) 192
07	35	125	(-4) 95	250	(-8) 118	590	(-18) 167	1 180	(-30) 218
08	40	145	(-4) 104	290	(-9) 136	740	(-20) 195	1 470	(-33) 258
09	45	170	(-5) 115	340	(-10) 147	880	(-22) 212	1 770	(-37) 280
10	50	195	(-6) 129	390	(-11) 163	980	(-23) 233	1 960	(-37) 306
11	55	245	(-7) 141	490	(-13) 181	1 180	(-26) 255	2 350	(-42) 337
12	60	295	(-8) 155	590	(-15) 202	1 470	(-29) 281	2 940	(-47) 374
13	65	345	(-9) 177	690	(-15) 221	1 670	(-30) 314	3 330	(-48) 414
14	70	390	(-8) 188	780	(-15) 238	1 860	(-30) 331	3 730	(-49) 438
15	75	415	(-8) 199	830	(-15) 253	1 960	(-30) 352	3 920	(-49) 466
16	80	465	(-9) 200	930	(-17) 258	2 160	(-33) 356	4 310	(-54) 472
17	85	540	(-10) 217	1 080	(-19) 283	2 450	(-35) 383	4 900	(-57) 507
18	90	635	(-12) 239	1 270	(-21) 304	2 940	(-39) 416	5 880	(-64) 556
19	95	685	(-13) 240	1 370	(-23) 308	3 140	(-42) 419	6 280	(-68) 557
20	100	785	(-14) 251	1 570	(-25) 325	3 530	(-45) 441	7 060	(-73) 587
21	105	885	(-15) 267	1 770	(-27) 348	3 920	(-48) 471	7 850	(-77) 624
22	110	980	(-16) 280	1 960	(-29) 368	4 410	(-51) 496	8 830	(-82) 660
24	120	1 140	(-15) 315	2 280	(-28) 409	5 180	(-52) 559	10 350	(-85) 739
26	130	1 200	(-15) 334	2 410	(-28) 435	5 500	(-52) 595	11 000	(-83) 788
28	140	1 480	(-18) 373	2 970	(-32) 481	6 650	(-58) 654	13 480	(-93) 870
30	150	1 810	(-21) 416	3 620	(-36) 532	7 990	(-64) 719	16 350	(-104) 960

The value in () shows a measured axial clearance.

Preload and Rigidity

4. PRELOAD AND RIGIDITY

Preload and Rigidity (DB and DF Arrangement)

High Precision Angular Contact Ball Bearings

(Standard series)

72 series, A angle
Nominal contact angle 30° Steel ball

Bore Number	Nominal Bearing Bore (mm)	EL		L		M		H					
		Preload (N)	Axial Rigidity (N/μm)	Preload (N)	Axial Rigidity (N/μm)	Preload (N)	Axial Rigidity (N/μm)	Preload (N)	Axial Rigidity (N/μm)				
00	10	25	(0)	44	100	(-5)	71	210	(-10)	94	-	-	
01	12	25	(0)	47	110	(-5)	78	220	(-10)	103	360	(-15)	125
02	15	25	(0)	50	110	(-5)	85	240	(-10)	114	390	(-15)	139
03	17	25	(0)	52	190	(-5)	108	250	(-10)	120	410	(-15)	145
04	20	25	(0)	55	260	(-10)	128	440	(-15)	155	650	(-20)	180
05	25	50	(0)	79	350	(-10)	160	580	(-15)	193	840	(-20)	223
06	30	50	(0)	85	380	(-10)	175	630	(-15)	210	910	(-20)	423
07	35	50	(0)	88	400	(-10)	184	660	(-15)	220	1 270	(-25)	285
08	40	50	(0)	95	440	(-10)	205	730	(-15)	246	1 470	(-26)	318
09	45	50	(0)	98	450	(-10)	212	1 080	(-20)	292	1 860	(-30)	363
10	50	50	(0)	103	480	(-10)	227	1 180	(-20)	314	2 060	(-30)	390
11	55	50	(0)	106	490	(-10)	235	1 670	(-26)	364	2 650	(-35)	438
12	60	50	(0)	110	510	(-10)	246	1 670	(-25)	380	2 750	(-35)	455
13	65	50	(0)	117	550	(-10)	270	1 860	(-25)	416	3 040	(-35)	500
14	70	100	(0)	150	1 080	(-15)	345	2 650	(-30)	480	3 920	(-40)	562
15	75	100	(0)	157	1 080	(-15)	366	2 750	(-30)	512	4 220	(-40)	598
16	80	100	(0)	154	1 080	(-15)	355	2 650	(-30)	494	4 020	(-40)	575
17	85	100	(0)	160	1 180	(-16)	370	3 430	(-35)	560	5 790	(-50)	678
18	90	100	(0)	162	1 670	(-20)	434	4 310	(-40)	615	5 980	(-50)	697
19	95	360	(-5)	248	1 670	(-20)	421	4 220	(-40)	595	6 670	(-55)	710
20	100	370	(-5)	252	1 670	(-20)	430	5 100	(-45)	645	7 650	(-60)	758
21	105	380	(-5)	260	2 260	(-25)	493	5 200	(-45)	665	8 920	(-65)	818
22	110	380	(-5)	266	2 350	(-25)	504	6 180	(-50)	720	10 200	(-70)	871
24	120	550	(-5)	320	2 840	(-25)	570	8 140	(-55)	843	11 570	(-70)	964
26	130	560	(-5)	340	3 730	(-30)	660	9 810	(-60)	942	13 530	(-75)	1 068
28	140	580	(-5)	352	5 000	(-36)	750	11 470	(-65)	1 022	15 490	(-80)	1 150
30	150	600	(-5)	366	5 000	(-35)	772	12 100	(-66)	1 063	16 500	(-81)	1 194

Calculation of radial rigidity
Multiply axial rigidity by factors
in table A.

Table A

	EL	L	M	H
15°	6.5	6.0	5.0	4.5
18°		4.5		
25°			2.0	
30°			1.4	
40°	0.7			

Calculation of preload and axial rigidity for combination bearings
Preload and axial rigidity can be obtained by multiplying factors in table B.
For radial rigidity, multiply the value obtained in table A with factors in table B.

Table B

	DBD	DBB
Preload factor	1.36	2
Axial rigidity	1.48	2
Radial rigidity	1.54	2

Ultra High Speed Angular Contact Ball Bearings

(ROBUST series)

BNR19S, BNR29S
Nominal contact angle 18° Steel ball

Nominal Bearing Bore (mm)	EL		L		M				
	Preload (N)	Axial Rigidity (N/μm)	Preload (N)	Axial Rigidity (N/μm)	Preload (N)	Axial Rigidity (N/μm)			
25	25	(0)	26	94	(-8)	43	188	(-16)	57
30	50	(0)	36	100	(-8)	48	200	(-15)	63
35	50	(0)	37	140	(-8)	55	280	(-17)	73
40	50	(0)	38	140	(-8)	57	280	(-16)	74
45	50	(0)	41	150	(-8)	62	300	(-16)	82
50	50	(0)	44	160	(-8)	68	320	(-16)	89
55	50	(0)	46	170	(-8)	71	340	(-16)	94
60	50	(0)	47	170	(-8)	74	340	(-16)	97
65	50	(0)	50	180	(-8)	79	360	(-16)	104
70	50	(0)	50	180	(-8)	80	360	(-16)	104
75	50	(0)	52	180	(-8)	83	460	(-19)	117
80	50	(0)	53	190	(-8)	86	474	(-19)	121
85	50	(0)	54	190	(-8)	88	646	(-24)	138
90	100	(0)	75	280	(-8)	110	709	(-21)	154
95	100	(0)	76	290	(-8)	110	768	(-22)	163
100	100	(0)	72	330	(-10)	110	871	(-26)	161
105	100	(0)	74	330	(-10)	120	898	(-26)	166
110	100	(0)	76	400	(-12)	130	925	(-26)	172
120	100	(0)	78	410	(-12)	130	1 275	(-33)	198
130	100	(0)	80	712	(-20)	160	1 408	(-35)	209
140	100	(0)	82	732	(-20)	160	1 508	(-36)	220
150	200	(0)	110	930	(-20)	185	1 894	(-38)	242

High Precision Angular Contact Ball Bearings

(Miniature series)

Small size angular contact ball bearing | **70, 72 series, A angle**
Bearing numbers with a C suffix: nominal contact angle 15°, 30° Steel ball

Bearing Number	EL		L		M		H					
	Preload (N)	Axial Rigidity (N/μm)	Preload (N)	Axial Rigidity (N/μm)	Preload (N)	Axial Rigidity (N/μm)	Preload (N)	Axial Rigidity (N/μm)				
725C	1.3	(10)	4.0	5.5	(7)	7.3	12.1	(4)	10.3	24.2	(0)	14.4
725A	5.0	(3)	18.5	10.3	(2)	23.8	24.5	(0)	32.6	49.0	(-3)	42.5
706C	1.5	(10)	4.3	7.9	(6)	8.3	15.1	(3)	11.1	30.3	(-2)	15.4
706A	4.9	(3)	18.6	16.8	(1)	28.7	24.4	(0)	32.8	48.8	(-3)	42.4
726C	1.8	(9)	5.1	9.2	(5)	9.6	17.6	(2)	12.8	35.2	(-3)	27.8
726A	3.7	(3)	18.4	16.2	(1)	30.8	34.0	(-1)	40.3	68.0	(-4)	52.4
707C	1.8	(9)	5.1	9.2	(5)	9.6	17.6	(2)	12.8	35.2	(-3)	17.8
707A	3.7	(3)	18.4	16.2	(1)	30.8	34.0	(-1)	40.3	68.0	(-4)	52.4
708C	4.2	(7)	7.5	14.1	(3)	12.2	28.6	(-1)	16.7	57.1	(-7)	23.3
708A	8.1	(2)	26.3	24.5	(0)	38.8	46.4	(-2)	48.9	92.8	(-5)	63.4
728C	4.2	(7)	7.5	14.1	(3)	12.2	28.5	(-1)	16.7	57.0	(-7)	23.3
728A	8.1	(2)	26.3	24.5	(-1)	38.8	46.4	(-2)	48.9	92.9	(-5)	63.4

The value in () shows a measured axial clearance.

BER19S, BER29S
Nominal contact angle 25° Steel ball

Nominal Bearing Bore (mm)	EL		L		M				
	Preload (N)	Axial Rigidity (N/μm)	Preload (N)	Axial Rigidity (N/μm)	Preload (N)	Axial Rigidity (N/μm)			
25	25	(0)	42	150	(-8)	80	300	(-14)	105
30	25	(0)	58	160	(-8)	90	320	(-14)	116
35	50	(0)	61	210	(-8)	100	420	(-15)	132
40	50	(0)	63	220	(-8)	110	440	(-15)	137
45	50	(0)	67	240	(-8)	120	480	(-15)	152
50	50	(0)	72	250	(-8)	130	500	(-15)	164
55	50	(0)	75	260	(-8)	140	520	(-15)	174
60	50	(0)	78	270	(-8)	140	540	(-15)	181
65	50	(0)	82	290	(-8)	150	580	(-15)	196
70	50	(0)	83	290	(-8)	150	598	(-15)	198
75	50	(0)	86	300	(-8)	160	619	(-15)	206
80	50	(0)	88	310	(-8)	170	639	(-15)	214
85	50	(0)	90	310	(-8)	170	889	(-19)	245
90	100	(0)	120	430	(-8)	210	968	(-17)	273
95	100	(0)	130	440	(-8)	210	996	(-17)	282
100	100	(0)	120	520	(-10)	210	1 131	(-20)	279
105	100	(0)	120	530	(-10)	220	1 169	(-20)	290
110	100	(0)	130	550	(-10)	230	1 206	(-20)	301
120	100	(0)	130	680	(-12)	250	1 743	(-26)	351
130	100	(0)	135	972	(-16)	289	1 880	(-27)	368
140	100	(0)	135	1 002	(-16)	300	1 944	(-27)	381
150	200	(0)	175	1 308	(-17)	336	2 555	(-30)	428

The value in () shows a measured axial clearance.

4. PRELOAD AND RIGIDITY

Preload and Rigidity (DB and DF Arrangement)

Ultra High Speed Angular Contact Ball Bearings

(ROBUST series)

Calculation of radial rigidity
Multiply axial rigidity by factors
in table A.

Table A

	EL	L	M	H
15°	6.5	6.0	5.0	4.5
18°		4.5		
25°			2.0	
30°			1.4	
40°	0.7			

Calculation of preload and axial rigidity for combination bearings
Preload and axial rigidity can be obtained by multiplying factors in table B.
For radial rigidity, multiply the value obtained in table A with factors in table B.

Table B

	DBD	DBB
Preload factor	1.36	2
Axial rigidity	1.48	2
Radial rigidity	1.54	2

BNR19H, BNR19X, BNR19XE, BNR29H BNR29X

Nominal contact angle 18° Ceramic ball

Nominal Bearing Bore (mm)	EL		L		M	
	Preload (N)	Axial Rigidity (N/μm)	Preload (N)	Axial Rigidity (N/μm)	Preload (N)	Axial Rigidity (N/μm)
25	25	(0)	29	105 (-8)	51	210 (-15)
30	50	(0)	40	110 (-8)	55	220 (-15)
35	50	(0)	41	150 (-8)	64	300 (-16)
40	50	(0)	42	160 (-8)	66	320 (-17)
45	50	(0)	45	170 (-8)	72	340 (-16)
50	50	(0)	49	180 (-8)	78	360 (-16)
55	50	(0)	51	180 (-8)	82	360 (-15)
60	50	(0)	52	190 (-8)	85	380 (-16)
65	50	(0)	55	200 (-8)	91	400 (-16)
70	50	(0)	56	200 (-8)	92	400 (-16)
75	50	(0)	58	200 (-8)	96	525 (-19)
80	50	(0)	59	210 (-8)	99	542 (-19)
85	50	(0)	61	210 (-8)	100	744 (-24)
90	100	(0)	83	310 (-8)	130	804 (-21)
95	100	(0)	85	310 (-8)	130	873 (-22)
100	100	(0)	81	360 (-10)	130	994 (-26)
105	100	(0)	83	370 (-10)	130	1 026 (-26)
110	100	(0)	85	450 (-12)	150	1 058 (-26)
120	100	(0)	87	460 (-12)	150	1 469 (-33)
130	100	(0)	90	809 (-20)	158	1 625 (-35)
140	100	(0)	92	833 (-20)	195	1 744 (-36)
150	200	(0)	120	1 040 (-20)	214	2 166 (-38)

BNR10S, BNR20S

Nominal contact angle 18° Steel ball

Nominal Bearing Bore (mm)	EL		L		M	
	Preload (N)	Axial Rigidity (N/μm)	Preload (N)	Axial Rigidity (N/μm)	Preload (N)	Axial Rigidity (N/μm)
30	50	(0)	39	110 (-5)	52	220 (-13)
35	50	(0)	41	110 (-5)	55	220 (-12)
40	50	(0)	44	110 (-5)	60	220 (-11)
45	50	(0)	44	110 (-5)	60	220 (-11)
50	50	(0)	47	120 (-5)	64	249 (-12)
55	50	(0)	48	120 (-5)	67	302 (-14)
60	50	(0)	51	130 (-5)	71	345 (-15)
65	50	(0)	53	130 (-5)	75	364 (-15)
70	50	(0)	53	230 (-10)	93	505 (-20)
75	50	(0)	54	240 (-10)	96	520 (-20)
80	100	(0)	71	330 (-10)	110	606 (-19)
85	100	(0)	73	330 (-10)	110	622 (-19)
90	100	(0)	74	340 (-10)	120	823 (-24)
95	100	(0)	76	350 (-10)	120	846 (-24)
100	100	(0)	78	350 (-10)	120	870 (-24)
105	100	(0)	80	420 (-12)	130	1 054 (-27)
110	100	(0)	81	540 (-15)	150	1 144 (-29)
120	100	(0)	85	560 (-15)	160	1 208 (-29)
130	100	(0)	85	732 (-20)	166	1 508 (-36)
140	200	(0)	105	775 (-15)	178	1 606 (-30)
150	200	(0)	110	916 (-18)	190	1 917 (-35)

BER19H, BER19X, BER19XE, BER29H, BER29X

Nominal contact angle 25° Ceramic ball

Nominal Bearing Bore (mm)	EL		L		M	
	Preload (N)	Axial Rigidity (N/μm)	Preload (N)	Axial Rigidity (N/μm)	Preload (N)	Axial Rigidity (N/μm)
25	25	(0)	47	172 (-8)	96	342 (-14)
30	50	(0)	65	180 (-8)	100	360 (-14)
35	50	(0)	68	240 (-8)	120	480 (-15)
40	50	(0)	70	250 (-8)	120	500 (-15)
45	50	(0)	75	260 (-8)	140	520 (-15)
50	50	(0)	80	280 (-8)	150	560 (-15)
55	50	(0)	84	300 (-8)	160	600 (-15)
60	50	(0)	87	300 (-8)	160	600 (-14)
65	50	(0)	92	320 (-8)	180	640 (-14)
70	50	(0)	93	330 (-8)	180	689 (-15)
75	50	(0)	96	340 (-8)	190	713 (-15)
80	50	(0)	98	350 (-8)	190	738 (-15)
85	50	(0)	100	360 (-8)	200	1 032 (-19)
90	100	(0)	140	480 (-8)	240	1 110 (-17)
95	100	(0)	140	490 (-8)	250	1 143 (-17)
100	100	(0)	130	580 (-10)	250	1 302 (-20)
105	100	(0)	140	600 (-10)	260	1 346 (-20)
110	100	(0)	140	620 (-10)	260	1 390 (-20)
120	100	(0)	150	780 (-12)	300	2 023 (-26)
130	100	(0)	150	1 115 (-16)	340	2 185 (-27)
140	100	(0)	150	1 151 (-16)	353	2 261 (-27)
150	200	(0)	198	1 484 (-17)	393	2 948 (-30)

BER10S, BER20S

Nominal contact angle 25° Steel ball

Nominal Bearing Bore (mm)	EL		L		M	
	Preload (N)	Axial Rigidity (N/μm)	Preload (N)	Axial Rigidity (N/μm)	Preload (N)	Axial Rigidity (N/μm)
30	50	(0)	63	220 (-8)	110	440 (-15)
35	50	(0)	67	240 (-8)	120	480 (-15)
40	50	(0)	72	250 (-8)	130	500 (-15)
45	50	(0)	73	250 (-8)	130	500 (-15)
50	50	(0)	77	270 (-8)	140	540 (-15)
55	50	(0)	80	350 (-10)	160	700 (-18)
60	50	(0)	84	380 (-10)	170	760 (-18)
65	50	(0)	88	400 (-10)	180	800 (-18)
70	50	(0)	88	400 (-10)	180	800 (-18)
75	50	(0)	90	510 (-12)	200	1 020 (-21)
80	100	(0)	120	620 (-12)	220	1 240 (-22)
85	100	(0)	120	640 (-12)	230	1 280 (-22)
90	100	(0)	120	650 (-12)	240	1 300 (-22)
95	100	(0)	130	670 (-12)	240	1 340 (-22)
100	100	(0)	130	690 (-12)	250	1 380 (-22)
105	100	(0)	130	910 (-15)	290	1 820 (-26)
110	100	(0)	130	930 (-15)	290	1 860 (-26)
120	100	(0)	140	980 (-15)	310	1 960 (-26)
130	100	(0)	140	1 002 (-16)	310	2 004 (-27)
140	200	(0)	180	1 098 (-13)	325	2 196 (-23)
150	200	(0)	180	1 274 (-15)	345	2 562 (-28)

The value in () shows a measured axial clearance.

The value in () shows a measured axial clearance.

Preload and Rigidity

4. PRELOAD AND RIGIDITY

Preload and Rigidity (DB and DF Arrangement)

Ultra High Speed Angular Contact Ball Bearings

(ROBUST series)

BNR10H, BNR10X, BNR10XE, BNR20H, BNR20X Nominal contact angle 18° Ceramic ball

Nominal Bearing Bore (mm)	EL		L		M	
	Preload (N)	Axial Rigidity (N/μm)	Preload (N)	Axial Rigidity (N/μm)	Preload (N)	Axial Rigidity (N/μm)
30	50	(0) 43	110	(-5) 59	240	(-13) 79
35	50	(0) 46	120	(-5) 63	240	(-12) 83
40	50	(0) 49	120	(-5) 68	240	(-11) 88
45	50	(0) 49	120	(-5) 69	240	(-11) 88
50	50	(0) 52	130	(-5) 73	279	(-12) 99
55	50	(0) 54	130	(-5) 76	341	(-14) 110
60	50	(0) 57	140	(-5) 82	391	(-15) 121
65	50	(0) 60	140	(-5) 87	413	(-15) 130
70	50	(0) 59	260	(-10) 110	578	(-20) 147
75	50	(0) 61	270	(-10) 110	597	(-20) 151
80	100	(0) 80	360	(-10) 130	684	(-19) 164
85	100	(0) 82	370	(-10) 130	703	(-19) 169
90	100	(0) 83	370	(-10) 130	938	(-24) 191
95	100	(0) 85	380	(-10) 140	965	(-24) 197
100	100	(0) 87	390	(-10) 140	993	(-24) 204
105	100	(0) 89	470	(-12) 160	1 209	(-27) 229
110	100	(0) 91	600	(-15) 170	1 315	(-29) 235
120	100	(0) 95	630	(-15) 180	1 391	(-29) 250
130	100	(0) 95	833	(-20) 195	1 745	(-36) 260
140	200	(0) 125	860	(-15) 206	1 829	(-31) 276
150	200	(0) 125	1 025	(-18) 221	2 194	(-35) 297

BER10H, BER10X, BER10XE, BER20H, BER20X Nominal contact angle 25° Ceramic ball

Nominal Bearing Bore (mm)	EL		L		M	
	Preload (N)	Axial Rigidity (N/μm)	Preload (N)	Axial Rigidity (N/μm)	Preload (N)	Axial Rigidity (N/μm)
30	50	(0) 71	250	(-8) 130	500	(-15) 163
35	50	(0) 75	260	(-8) 140	520	(-15) 175
40	50	(0) 80	280	(-8) 150	560	(-15) 191
45	50	(0) 81	280	(-8) 150	590	(-15) 192
50	50	(0) 86	300	(-8) 160	630	(-15) 208
55	50	(0) 89	400	(-10) 190	800	(-18) 240
60	50	(0) 94	430	(-10) 200	860	(-18) 260
65	50	(0) 99	450	(-10) 210	950	(-18) 280
70	50	(0) 98	450	(-10) 210	950	(-18) 280
75	50	(0) 100	580	(-12) 240	1 160	(-21) 306
80	100	(0) 130	700	(-12) 260	1 460	(-22) 336
85	100	(0) 130	720	(-12) 270	1 510	(-22) 347
90	100	(0) 140	740	(-12) 280	1 540	(-22) 355
95	100	(0) 140	760	(-12) 290	1 590	(-22) 367
100	100	(0) 150	780	(-12) 300	1 640	(-22) 381
105	100	(0) 150	1 040	(-15) 330	2 080	(-26) 430
110	100	(0) 150	1 060	(-15) 340	2 120	(-26) 440
120	100	(0) 160	1 120	(-15) 370	2 240	(-26) 469
130	100	(0) 160	1 150	(-16) 370	2 302	(-27) 469
140	200	(0) 200	1 240	(-13) 380	2 476	(-25) 489
150	200	(0) 200	1 444	(-15) 403	2 957	(-28) 552

The value in () shows a measured axial clearance.

Calculation of radial rigidity
Multiply axial rigidity by factors
in table A.

Table A

	EL	L	M	H
15°	6.5	6.0	5.0	4.5
18°		4.5		
25°			2.0	
30°			1.4	
40°	0.7			

Ultra High Precision Angular Contact Ball Bearings (ROBUST series-BGR)

BGR19S Nominal contact angle 15° Steel ball

Nominal Bearing Bore (mm)	EL	
	Preload (N)	Axial Rigidity (N/μm)
10	25	(0) 15.2
12	25	(0) 16.8
15	25	(0) 16.6
17	25	(0) 17.5
20	25	(0) 18.1
25	25	(0) 20.6

BGR10S Nominal contact angle 15° Steel ball

Nominal Bearing Bore (mm)	EL	
	Preload (N)	Axial Rigidity (N/μm)
6	25	(0) 11.0
7	25	(0) 12.0
8	25	(0) 13.0
10	25	(0) 14.0
12	25	(0) 15.0
15	25	(0) 16.0
17	25	(0) 17.0
20	25	(0) 18.0
25	25	(0) 19.0

BGR02S Nominal contact angle 15° Steel ball

Nominal Bearing Bore (mm)	EL	
	Preload (N)	Axial Rigidity (N/μm)
10	25	(0) 14.5
12	25	(0) 15.2
15	25	(0) 16.2
17	25	(0) 16.7
20	25	(0) 17.4
25	50	(0) 25.3

The value in () shows a measured axial clearance.

Calculation of preload and axial rigidity for combination bearings
Preload and axial rigidity can be obtained by multiplying factors in table B.
For radial rigidity, multiply the value obtained in table A with factors in table B.

Table B

	DBD	DBB
Preload factor	1.36	2
Axial rigidity	1.48	2
Radial rigidity	1.54	2

BGR19H, BGR19X Nominal contact angle 15° Ceramic ball

Nominal Bearing Bore (mm)	EL	
	Preload (N)	Axial Rigidity (N/μm)
10	25	(0) 16.8
12	25	(0) 18.5
15	25	(0) 18.4
17	25	(0) 19.3
20	25	(0) 20.1
25	25	(0) 22.9

BGR10H, BGR10X Nominal contact angle 15° Ceramic ball

Nominal Bearing Bore (mm)	EL	
	Preload (N)	Axial Rigidity (N/μm)
6	25	(0) 12.6
7	25	(0) 13.7
8	25	(0) 14.4
10	25	(0) 15.9
12	25	(0) 16.9
15	25	(0) 18.0
17	25	(0) 19.0
20	25	(0) 20.0
25	25	(0) 21.6

BGR02H, BGR02X Nominal contact angle 15° Ceramic ball

Nominal Bearing Bore (mm)	EL	
	Preload (N)	Axial Rigidity (N/μm)
10	25	(0) 16.0
12	25	(0) 17.0
15	25	(0) 18.0
17	25	(0) 18.6
20	25	(0) 19.4
25	50	(0) 28.1

4. PRELOAD AND RIGIDITY

Preload and Rigidity (DB and DF Arrangement) High Speed Angular Contact Thrust Ball Bearings (ROBUST series)

BAR10S Nominal contact angle 30° Steel ball

Nominal Bearing Bore (mm)	EL		L	
	Preload (N)	Axial Rigidity (N/μm)	Preload (N)	Axial Rigidity (N/μm)
40	210	(-5) 150	430 (-10)	200
45	210	(-5) 150	430 (-10)	200
50	220	(-5) 170	460 (-10)	220
55	230	(-5) 180	600 (-12)	250
60	240	(-5) 190	650 (-12)	270
65	250	(-5) 200	690 (-12)	290
70	250	(-5) 200	910 (-15)	320
75	260	(-5) 210	940 (-15)	330
80	340	(-5) 240	1 100 (-15)	360
85	350	(-5) 240	1 130 (-15)	370
90	360	(-5) 250	1 660 (-20)	430
95	360	(-5) 260	1 720 (-20)	450
100	370	(-5) 270	1 770 (-20)	460
105	380	(-5) 280	1 820 (-20)	470
110	390	(-5) 280	1 870 (-20)	490
120	390	(-5) 300	1 980 (-20)	520
130	390	(-5) 300	2 530 (-25)	550
140	580	(-5) 360	3 190 (-25)	655
150	580	(-5) 360	3 690 (-28)	690
160	590	(-5) 370	4 080 (-30)	720
170	600	(-5) 380	4 210 (-30)	750
180	605	(-5) 385	5 200 (-35)	800
190	610	(-5) 390	5 370 (-35)	830
200	610	(-5) 390	5 990 (-38)	860

BTR10S Nominal contact angle 40° Steel ball

Nominal Bearing Bore (mm)	EL		L	
	Preload (N)	Axial Rigidity (N/μm)	Preload (N)	Axial Rigidity (N/μm)
40	310	(-5) 260	700 (-10)	350
45	310	(-5) 260	700 (-10)	350
50	330	(-5) 290	760 (-10)	390
55	350	(-5) 310	800 (-10)	410
60	370	(-5) 330	860 (-10)	440
65	390	(-5) 350	910 (-10)	470
70	390	(-5) 350	1 560 (-15)	560
75	400	(-5) 360	1 610 (-15)	590
80	510	(-5) 400	1 820 (-15)	630
85	520	(-5) 420	1 880 (-15)	650
90	530	(-5) 430	2 830 (-20)	770
95	550	(-5) 450	2 930 (-20)	790
100	560	(-5) 460	3 030 (-20)	820
105	570	(-5) 470	3 120 (-20)	850
110	580	(-5) 490	3 210 (-20)	870
120	610	(-5) 520	3 420 (-20)	930
130	610	(-5) 520	4 410 (-25)	980
140	810	(-5) 600	5 310 (-25)	1 140
150	820	(-5) 605	5 370 (-25)	1 160
160	830	(-5) 615	5 480 (-25)	1 180
170	850	(-5) 635	7 280 (-30)	1 330
180	855	(-5) 640	9 080 (-35)	1 450
190	875	(-5) 660	9 390 (-35)	1 500
200	875	(-5) 660	11 290 (-38)	1 600

The value in () shows a measured axial clearance.

BAR10H Nominal contact angle 30° Ceramic ball

Nominal Bearing Bore (mm)	EL		L	
	Preload (N)	Axial Rigidity (N/μm)	Preload (N)	Axial Rigidity (N/μm)
40	230	(-5) 175	485 (-10)	230
45	230	(-5) 180	490 (-10)	235
50	245	(-5) 195	525 (-10)	255
55	255	(-5) 200	690 (-12)	290
60	270	(-5) 220	750 (-12)	320
65	285	(-5) 240	800 (-12)	340
70	285	(-5) 240	1 060 (-15)	375
75	290	(-5) 245	1 090 (-15)	390
80	380	(-5) 275	1 260 (-15)	420
85	390	(-5) 280	1 280 (-15)	430
90	400	(-5) 290	1 930 (-20)	510
95	405	(-5) 300	1 970 (-20)	520
100	420	(-5) 310	2 060 (-20)	550
105	420	(-5) 315	2 090 (-20)	555
110	440	(-5) 330	2 180 (-20)	580
120	455	(-5) 350	2 310 (-20)	620
130	455	(-5) 350	2 960 (-25)	650

BTR10H Nominal contact angle 40° Ceramic ball

Nominal Bearing Bore (mm)	EL		L	
	Preload (N)	Axial Rigidity (N/μm)	Preload (N)	Axial Rigidity (N/μm)
40	350	(-5) 300	800 (-10)	410
45	355	(-5) 310	810 (-10)	415
50	375	(-5) 335	875 (-10)	450
55	395	(-5) 350	915 (-10)	475
60	425	(-5) 390	1 000 (-10)	520
65	450	(-5) 415	1 060 (-10)	560
70	450	(-5) 415	1 830 (-15)	670
75	460	(-5) 430	1 890 (-15)	700
80	570	(-5) 475	2 120 (-15)	745
85	580	(-5) 475	2 160 (-15)	780
90	600	(-5) 505	3 320 (-20)	910
95	605	(-5) 505	3 390 (-20)	940
100	630	(-5) 540	3 560 (-20)	980
105	640	(-5) 540	3 610 (-20)	1 010
110	665	(-5) 575	3 770 (-20)	1 040
120	700	(-5) 615	4 020 (-20)	1 115
130	700	(-5) 615	5 200 (-25)	1 170

Preload and Rigidity Double-Direction Angular Contact Thrust Ball Bearings (TAC series)

TAC20 series Nominal contact angle 60° Steel ball

Nominal Bearing Bore (mm)	C6		C7		C8	
	Preload (N)	Axial Rigidity (N/μm)	Preload (N)	Axial Rigidity (N/μm)	Preload (N)	Axial Rigidity (N/μm)
140	980	1 200	3 626	1 900	9 310	2 600
150	980	1 210	4 704	2 060	9 408	2 640
160	1 274	1 370	4 802	2 140	10 780	2 830
170	2 058	1 650	6 762	2 450	13 720	3 120
180	2 940	1 875	6 762	2 475	15 680	3 265
190	3 038	1 940	7 056	2 560	18 620	3 560
200	3 038	1 950	7 056	2 570	18 620	3 570

TAC29 series Nominal contact angle 60° Steel ball

Nominal Bearing Bore (mm)	C6		C7		C8	
	Preload (N)	Axial Rigidity (N/μm)	Preload (N)	Axial Rigidity (N/μm)	Preload (N)	Axial Rigidity (N/μm)
150	196	775	4 116	2 150	7 056	2 590
160	196	800	4 410	2 260	7 448	2 720
170	196	800	4 410	2 370	7 742	2 860
180	1 078	1 470	4 410	2 320	9 800	3 040
190	1 078	1 440	4 606	2 440	10 290	3 200
200	1 078	1 500	4 606	2 430	11 760	3 340
220	1 176	1 615	4 900	2 620	12 740	3 615
240	1 176	1 690	5 096	2 750	13 230	3 800
260	1 176	1 670	5 096	2 720	13 230	3 750
280	1 274	1 755	5 390	2 865	13 720	3 950

Preload and Rigidity

Angular Contact Thrust Ball Bearing for Ball Screw Support

TAC B series (for machine tool)

Nominal contact angle 60° Steel ball

C9 Preload

Bearing Number	Duplex Set Arrangement (DB or DF)			Triplex Set Arrangement (DBD or DFD)			Quadruplex Set Arrangement (DBB or DFF)		
	Preload (N)	Axial Rigidity (N/μm)	Starting Torque (N-m)	Preload (N)	Axial Rigidity (N/μm)	Starting Torque (N-m)	Preload (N)	Axial Rigidity (N/μm)	Starting Torque (N-m)
15TAC47B	1 000	555	0.05	1 370	795	0.07	2 010	1 110	0.11
17TAC47B	1 000	555	0.05	1 370	795	0.07	2 010	1 110	0.11
20TAC47B	1 000	555	0.05	1 370	795	0.07	2 010	1 110	0.11
25TAC62B	1 490	733	0.09	2 030	1 050	0.12	2 980	1 465	0.17
30TAC62B	1 563	772	0.09	2 130	1 105	0.12	3 130	1 545	0.18
35TAC72B	1 785	890	0.10	2 430	1 275	0.14	3 570	1 780	0.21
40TAC72B	1 860	930	0.11	2 530	1 330	0.14	3 720	1 860	0.21
40TAC90B	2 365	1 015	0.18	3 220	1 465	0.24	4 730	2 030	0.36
45TAC75B	2 005	1 005	0.12	2 730	1 445	0.16	4 015	2 015	0.23
45TAC100B	2 880	1 160	0.23	3 920	1 670	0.31	5 760	2 320	0.46
50TAC100B	3 010	1 210	0.24	4 095	1 745	0.32	6 020	2 425	0.48
55TAC100B	3 010	1 210	0.24	4 095	1 745	0.32	6 020	2 425	0.48
55TAC120B	3 520	1 430	0.28	4 790	2 055	0.37	7 040	2 855	0.56
60TAC120B	3 520	1 430	0.28	4 790	2 055	0.37	7 040	2 855	0.56

C10 Preload

Bearing Number	Duplex Set Arrangement (DB or DF)			Triplex Set Arrangement (DBD or DFD)			Quadruplex Set Arrangement (DBB or DFF)		
	Preload (N)	Axial Rigidity (N/μm)	Starting Torque (N-m)	Preload (N)	Axial Rigidity (N/μm)	Starting Torque (N-m)	Preload (N)	Axial Rigidity (N/μm)	Starting Torque (N-m)
15TAC47B	2 150	750	0.14	2 950	1 080	0.20	4 300	1 470	0.29
17TAC47B	2 150	750	0.14	2 950	1 080	0.20	4 300	1 470	0.29
20TAC47B	2 150	750	0.14	2 950	1 080	0.20	4 300	1 470	0.29
25TAC62B	3 150	1 000	0.23	4 300	1 470	0.31	6 250	1 960	0.46
30TAC62B	3 350	1 030	0.24	4 500	1 520	0.33	6 650	2 010	0.49
35TAC72B	3 800	1 180	0.28	5 200	1 710	0.37	7 650	2 350	0.55
40TAC72B	3 900	1 230	0.28	5 300	1 810	0.38	7 850	2 400	0.57
40TAC90B	5 000	1 320	0.48	6 750	1 960	0.65	10 300	2 650	0.96
45TAC75B	4 100	1 270	0.29	5 600	1 910	0.40	8 250	2 550	0.59
45TAC100B	5 900	1 520	0.58	8 050	2 210	0.78	11 800	3 000	1.16
50TAC100B	6 100	1 570	0.60	8 250	2 300	0.80	12 300	3 100	1.18
55TAC100B	6 100	1 570	0.60	8 250	2 300	0.80	12 300	3 100	1.18
55TAC120B	6 650	1 810	0.64	9 100	2 650	0.86	13 200	3 550	1.27
60TAC120B	6 650	1 810	0.64	9 100	2 650	0.86	13 200	3 550	1.27

TAC 02, 03 series (for electric injection machine)

Nominal contact angle 50°–55° Steel ball

C8 Preload

Bearing Number	Duplex Set Arrangement (DB or DF)			Triplex Set Arrangement (DBD or DFD)			Quadruplex Set Arrangement (DBT or DFT)		
	Preload (N)	Axial Rigidity (N/μm)	Starting Torque (N-m)	Preload (N)	Axial Rigidity (N/μm)	Starting Torque (N-m)	Preload (N)	Axial Rigidity (N/μm)	Starting Torque (N-m)
15TAC02AT85	365	262	0.017	495	385	0.024	575	490	0.027
25TAC02AT85 ⁽¹⁾	1 440	520	0.113	1 960	755	0.153	2 260	950	0.175
TAC35-2T85	2 270	705	0.266	3 100	1 020	0.360	3 550	1 280	0.415
40TAC03AT85	2 270	705	0.266	3 100	1 020	0.360	3 550	1 280	0.415
45TAC03AT85	2 740	775	0.355	3 750	1 120	0.480	4 300	1 410	0.550
TAC45-2T85	3 550	880	0.520	4 850	1 270	0.705	5 600	1 600	0.810
50TAC03AT85	3 550	880	0.520	4 850	1 270	0.705	5 600	1 600	0.810
55TAC03AT85	4 100	945	0.650	5 600	1 370	0.880	6 500	1 720	1.000
60TAC03AT85	4 750	1 020	0.810	6 450	1 480	1.100	7 450	1 850	1.250
80TAC03AM	7 350	1 270	1.550	10 000	1 840	2.100	11 500	2 330	2.450
100TAC03CMC ⁽²⁾	1 000	830	0.105	1 400	1 240	0.147	1 600	1 575	0.166
120TAC03CMC ⁽²⁾	1 100	930	0.120	1 500	1 378	0.163	1 800	1 775	0.196

⁽¹⁾ Value of 25TAC02AT85 is based on H preload.

⁽²⁾ Values of 100TAC03CMC and 120TAC03CMC are based on EL preload.

Radial Internal Clearance of Cylindrical Roller Bearings

Clearance in matched bearings with tapered bore

Unit: μm

Nominal Bearing Bore (mm)	Clearance in Matched Bearings with Tapered Bore																	
			CC9 ⁽¹⁾		CC0		CC1		CC2		CC ⁽²⁾		CC3		CC4		CC5	
	over	incl	min.	max.	min.	max.	min.	max.	min.	max.	min.	max.	min.	max.	min.	max.	min.	max.
24	30	5	10	8	15	10	25	25	35	40	50	50	60	60	70	80	95	
30	40	5	12	8	15	12	25	25	40	45	55	55	70	70	80	95	110	
40	50	5	15	10	20	15	30	30	45	50	65	65	80	80	95	110	125	
50	65	5	15	10	20	15	35	35	50	55	75	75	90	90	110	130	150	
65	80	10	20	15	30	20	40	40	60	70	90	90	110	110	130	150	170	
80	100	10	25	20	35	25	45	45	70	80	105	105	125	125	150	180	205	
100	120	10	25	20	35	25	50	50	80	95	120	120	145	145	170	205	230	
120	140	15	30	25	40	30	60	60	90	105	135	135	160	160	190	230	260	
140	160	15	35	30	50	35	65	65	100	115	150	150	180	180	215	260	295	
160	180	15	35	30	50	35	75	75	110	125	165	165	200	200	240	285	320	
180	200	20	40	30	50	40	80	80	120	140	180	180	220	220	260	315	355	
200	225	20	45	35	60	45	90	90	135	155	200	200	240	240	285	350	395	
225	250	25	50	40	65	50	100	100	150	170	215	215	265	265	315	380	430	
250	280	25	55	40	70	55	110	110	165	185	240	240	295	295	350	420	475	

⁽¹⁾ Applicable to cylindrical roller bearings of ISO accuracy Class 4 and 5 with tapered bores.

⁽²⁾ Denotes normal clearance for matched cylindrical roller bearings.

Clearance in matched bearings with cylindrical bore

Unit: μm

Nominal Bearing Bore (mm)	Clearance in Matched Bearings with Cylindrical Bore													
			CC1		CC2		CC ⁽²⁾		CC3		CC4		CC5	
	over	incl	min.	max.	min.	max.	min.	max.	min.	max.	min.	max.	min.	max.
24	30	5	15	10	25	25	35	40	50	50	60	70	80	
30	40	5	15	12	25	25	40	45	55	55	70	80	95	
40	50	5	18	15	30	30	45	50	65	65	80	95	110	
50	65	5	20	15	35	35	50	55	75	75	90	110	130	
65	80	10	25	20	40	40	60	70	90	90	110	130	150	
80	100	10	30	25	45	45	70	80	105	105	125	155	180	
100	120	10	30	25	50	50	80	95	120	120	145	180	205	
120	140	10	35	30	60	60	90	105	135	135	160	200	230	
140	160	10	35	35	65	65	100	115	150	150	180	225	260	
160	180	10	40	35	75	75	110	125	165	165	200	250	285	
180	200	15	45	40	80	80	120	140	180	180	220	275	315	
200	225	15	50	45	90	90	135	155	200	200	240	305	350	
225	250	15	50	50	100	100	150	170	215	215	265	330	380	
250	280	20	55	55	110	110	165	185	240	240	295	370	420	

⁽²⁾ Denotes normal clearance for matched cylindrical roller bearings.

Limiting Speeds

The limiting speeds listed in the Bearing Dimensional Tables are guideline values. They are based on a single bearing that is lightly preloaded by means of a spring and subjected to relatively light loads with good heat dissipation.

The limiting speeds with grease lubrication are determined using high quality grease in appropriate amounts. Those listed for oil lubrication are based on the use of oil-air (or oil mist) lubrication. In situations where the lubricating oil is used as a means to remove heat, higher speed can be achieved, however a large amount of oil must be pressure fed through the bearing, so there is a significant loss of power.

When single bearings are used in two, three or four row combinations, or the preload is increased to improve spindle rigidity, limiting speeds will be lower than those listed.

Please consult NSK for grease lubrication, as grease life must be also taken into consideration.

Speed Factors

The limiting speed of a matched bearing set operating under position preload conditions is calculated by multiplying the limiting speed of a single bearing in the set by the appropriate adjustment factor listed in Table 5.1.

In this table, preloads mean the preload values after the bearing has been attached to the spindle. Preload values after the bearing has been mounted on the spindle will change as a result of the shaft fit requirements of high speed operation and spacer deformation due to tightening force. In such case, particular in high speed applications, it is necessary to adjust the spacer lengths relative to each other in order to compensate for the changes in preload after bearing mounting.

Table 5.1 Speed Factors

	Arrangement	EL	L	M	H
DB		0.85	0.80	0.65	0.55
DBB		0.80	0.75	0.60	0.45
DBD		0.75	0.70	0.55	0.40

Factors that Change Preload

Fig. 5.1 Preload Setting Study Flow

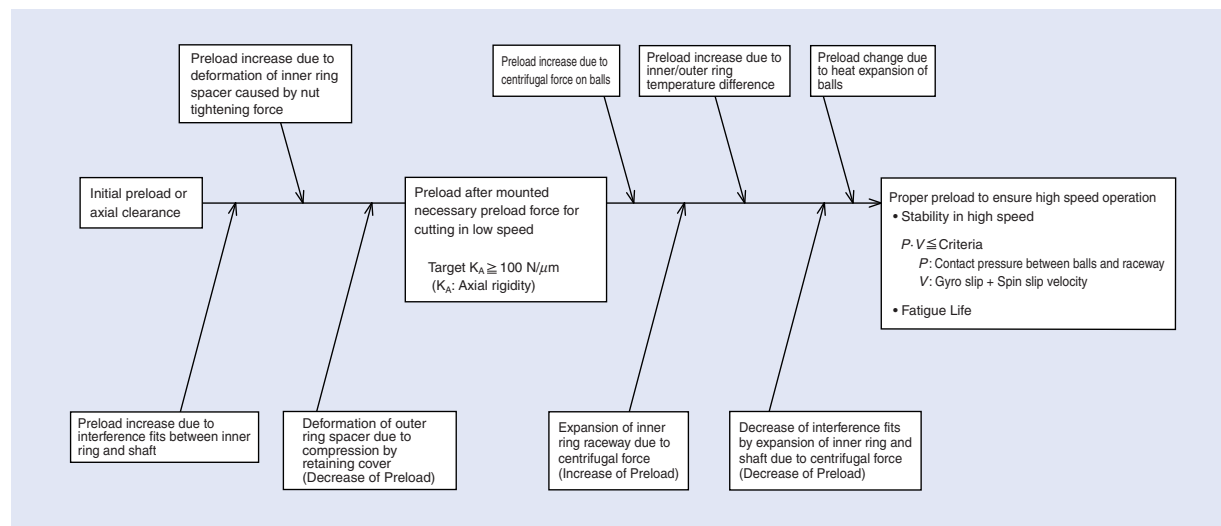

Factors Influencing Limiting Speeds

The limiting speed of the bearing, inside of the spindle, is affected by the following operating conditions.

1. Lubrication Method

The thickness of the lubricating film created by the oil-air or oil mist lubrication replenishment method is larger compared to the thickness created by the grease lubrication method. Therefore the limiting speed is higher when the oil-air or oil mist lubrication method is used.

In the case of jet lubrication, the large volume of oil supplied into the bearing for lubrication also removes heat efficiently so that much higher operating speeds are possible.

2. Combination

If bearings are used as multiple bearing sets, the number of bearings in the set affects the limiting speed. As the number is increased, the limiting speed becomes lower because the ability to dissipate that heat becomes lower.

3. Preload

If the preload after mounted is high, the contact surface pressure between the rolling elements and raceways increases, which causes extra heat. As a result of this heat, the preload during operation increases further and the risk of bearing failure will be higher. To avoid this type of bearing failure, the limiting speed is reduced. Also in case of cylindrical roller bearings, when the radial clearance is reduced and the preload increases during operation, the limiting speed is reduced.

4. Drive Method

The limiting speed of a bearing will also change depending on the spindle drive system.

In the case of motor built-in spindles the heat inside of the spindles is higher. If there is also a jacket-cooling system, the temperature difference between the inner ring and the outer ring becomes higher, so the preload is increased and the limiting speed becomes lower (see Fig. 5.2). Jacket cooling also affects the clearance between the bearing and the housing (see Fig. 5.3). Therefore, the clearance between the bearing and the housing could become negative, in which case the preload would be increased.

Fig. 5.2 The Influence of the Jacket Cooling on Limiting Speed

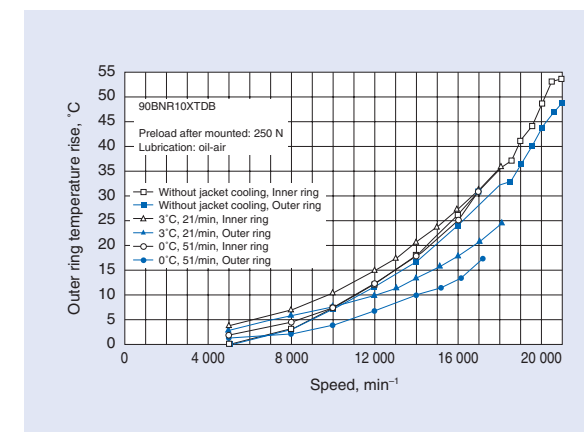
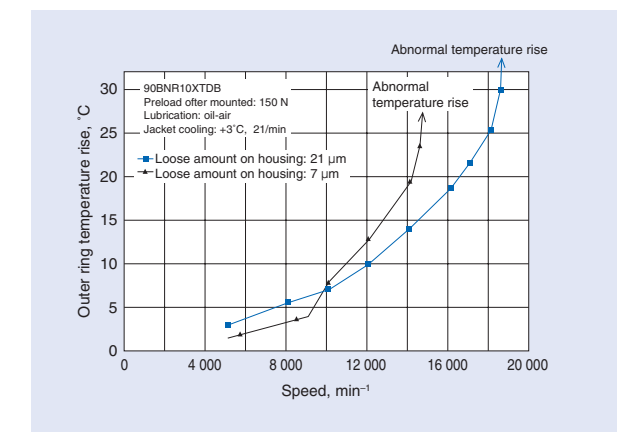

Fig. 5.3 The Influence of the Clearance between the Bearing & the Housing on Limiting Speed



Purposes of Lubrication

The main purposes of lubrication are to reduce friction and wear inside the bearing that may cause premature failure. The effects of lubrication may be briefly explained as follows:

(1) Reduction of Friction and Wear

Direct metallic contact between the bearing rings, rolling elements, and cage, which are the basic parts of a bearing, is prevented by an oil film which reduces the friction and wear in the contact areas.

(2) Extension of Fatigue Life

The rolling fatigue life of bearings depends greatly upon the viscosity and film thickness between the rolling contact surfaces. A heavy film thickness prolongs the fatigue life, but it is shortened if the viscosity of the oil is too low so the film thickness is insufficient.

(3) Dissipation of Heat

Circulating lubrication may be used to carry away frictional heat or heat transferred from the outside to prevent the bearing from overheating and oil from deteriorating.

(4) Others

Adequate lubrication also helps to prevent foreign material from entering the bearings and guards against corrosion or rusting.

Lubricating Methods

For machine tool spindles in which high accuracy is important, it is necessary to prevent excessive temperature rise of the spindle to reduce thermal deformation.

Bearing heat generation is divided into a load term determined by the bearing type and load, and a speed term determined by the lubricating method and speed.

Generally, the speed term is greater, but if a lubricating method resulting in a small speed term is selected, the influence of the load term cannot be disregarded. Therefore, it is important to select a low heat generating bearing (load term) and lubricating method (speed term).

Regarding heat generation, both the lubrication method and quantity of lubricant have important effects. Lubrication using a small amount of grease is common since this method is economical, maintenance free, and there is little heat generation. At high speeds, to maintain a constant low temperature, the oil-air lubrication method, which requires a minimum quantity of oil, was developed.

The relation between oil quantity and heat generation (frictional loss) and temperature rise is already known as shown in Fig. 6.1. Therefore, for machine tool spindles, to avoid excessive temperature rise, adoption of a lubricating method aiming at either zone A or B is necessary.

The lubricating methods in zones A and B are summarized in Table 6.1.

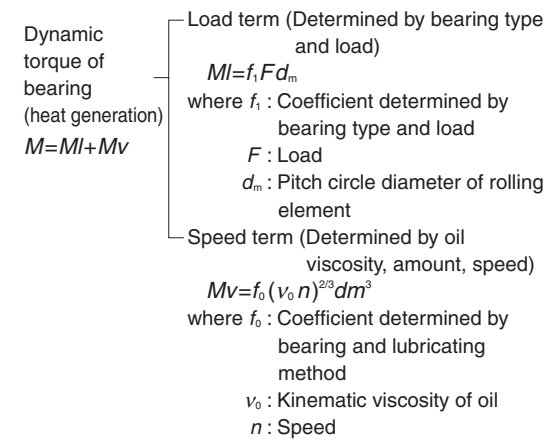

Fig. 6.1 Oil Quantity and Temperature Rise

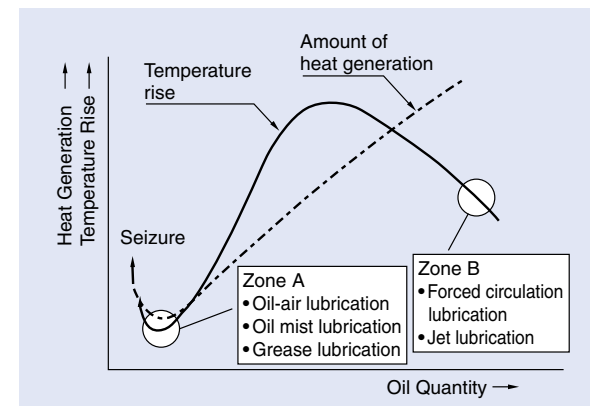

Table 6.1 Comparison of Lubricating Methods

Lubricating Methods	Advantages	Disadvantages
Grease Lubrication	<ul style="list-style-type: none"> □ Cost is low. □ Limitation of temperature rise is possible. □ Maintenance free. 	<ul style="list-style-type: none"> □ If packed grease deteriorates, seizure may occur. □ May allow penetration of dust or cutting fluid.
Oil Mist Lubrication	<ul style="list-style-type: none"> □ Since new oil is always fed, no fear of oil deterioration. □ Dust and cutting fluid cannot easily enter. 	<ul style="list-style-type: none"> □ Pollution of environment. □ Oil supply quantity varies depending on the oil viscosity and temperature, so control of a small flow rate is difficult. □ It is difficult to confirm that oil is actually fed.
Jet Lubrication	<ul style="list-style-type: none"> □ Since the oil flow rate is high, dust and cutting fluid cannot enter and seizure hardly ever occurs. □ Because of cooling by oil, the bearing temperature can be controlled to some degree. 	<ul style="list-style-type: none"> □ Frictional loss is high. □ Since oil leaks, it is difficult to use for vertical spindles. □ Cost is high.
Oil-Air Lubrication	<ul style="list-style-type: none"> □ Since oil quantity control is possible, the optimum quantity of oil is fed and heat generation is low. □ Besides little heat-generation, there is a cooling effect of the air, so the temperature is low. □ Since new oil is always fed, no fear of oil deterioration. □ Dust, cutting fluid cannot easily enter. □ Environmental pollution mist is slight. 	<ul style="list-style-type: none"> □ Cost is rather high. □ Confirmation of whether oil is actually fed to bearing is difficult.

Grease Lubrication

(1) Recommended Greases

Lithium base greases with mineral oil as the base oil have good sticking properties and excellent characteristics for rolling bearings. These are usually usable over a temperature range of -10°C to $+110^{\circ}\text{C}$.

As grease for high speed machine tool spindles that require low temperature rise and long life, a consistency No.2 grease with a synthetic base oil (diester, diester + mineral oil, etc.) is recommended.

Table 6.2 lists the brand names and properties of greases widely used in machine tools main spindles and ball screw support bearings.

(2) Grease Life

Grease life depends greatly upon operating temperature; therefore, it is necessary to keep the temperature of the bearing (including atmospheric temperature) cooler, in order to extend the grease life.

High performance wide range grease is often used for high

speed spindle bearings, or spindle motor bearings.

The following equation shows the mean life of wide range grease:

$$\log t = 6.12 - 1.4n/N_{\max} - (0.018 - 0.006n/N_{\max}) T$$

where t : Mean Grease life (h)
 N_{\max} : Limiting speed (min^{-1})
 n : Operating speed (min^{-1})
 T : Bearing running temperature ($^{\circ}\text{C}$)

(3) Quantity of Grease for High Speed Spindle Bearings

To operate bearings at high speed with grease lubrication, the recommended quantity to be packed is 10% to 20% of internal space. If too much grease is packed, during running in, abnormal heat generation occurs and this may cause the grease to deteriorate. To avoid such a risk, it is necessary to run in spindles for a sufficient time. Based on their experience, NSK determines the packing quantity which allows easy running in and will provide sufficient lubrication. For the amount, please refer to the tables on Page 175.

Table 6.2 Grease Brand Names and Properties

Brand names	Manufacturers	Thickeners	Base oils	Base oils viscosity $\text{mm}^2/\text{s}(40^{\circ}\text{C})$	Dropping point ($^{\circ}\text{C}$)	Working temperature range, ($^{\circ}\text{C}$)	Main application
MTE	NSK	Barium complex	Ester oil	23	200	-30 to $+120$	Bearings for high speed spindles, high speed cylindrical roller bearings
MTS	NSK	Urea	Ester+Synthetic hydro carbon oil	22	220	-40 to $+130$	Bearings for high speed spindles
Isoflex NBU15	Klüber	Barium complex	Diester oil + Mineral oil	20	250	-30 to $+120$	Bearings for main spindles
Multemps PS No.2	Kyodo Yushi	Lithium	Diester oil + Mineral oil	16	189	-50 to $+110$	Bearings for main spindles
Mobilux 2	Mobil	Lithium	Mineral oil	26	196	-10 to $+110$	Bearings for boring heads, live centers
Multemp LRL3	Kyodo Yushi	Lithium	Polyol ester oil	37	208	-30 to $+130$	Bearings for main spindles
Stabragas NBU8EP	Klüber	Barium complex	Mineral oil	105	220	-30 to $+130$	Heavy load cylindrical roller bearings
Alvania 2	Shell	Lithium	Mineral oil	130	182	-10 to $+110$	Ball screw support bearings
ENS	NSK	Urea	Polyol ester oil	32	260	-40 to $+160$	Bearings for motors
WPH	NSK	Diurea	Poly- α -olefin oil	96	259	-40 to $+150$	Ball screw support bearings

Oil Lubrication

(1) Oil Mist Lubrication and Oil-Air Lubrication (Minimal Oil Quantity Lubrication)

Spray oiling is a method of spraying oil by turning it into a mist using compressed air. It is also called oil mist lubrication.

Oil-air lubrication is a method of feeding oil continuously by injecting oil into a compressed air stream by means of a mixing valve that intermittently discharges the minimum quantity of oil using a constant-quantity piston.

Fig. 6.2 shows the recommended oil quantity for the lubrication methods described above, each quantity is for one bearing.

In case of oil mist lubrication, it's necessary to adjust the oil quantity to accommodate for the effects of the branches in path tubing, and leakage from the gaps around the spacers.

Please ask NSK, as the oil quantity should be increased, in cases where the $d_m n$ value is higher than 1 800 000.

For the position of the spray nozzle, please refer to Page 192.

(2) Jet Lubrication

Jet lubrication is mainly used for high speed bearings with a $d_m n$ value 100×10^4 . Through one to several nozzles, jets of lubricating oil under a constant pressure pass through the bearings. At high speed, the air surrounding the bearing rotates together with the bearing and forms an air wall. The speed of the jet from each nozzle must be faster by 20% than the circumferential speed of the inner ring outside surface. Since the jet lubrication uses a large quantity of oil, there is much agitation resistance, so it is necessary to dissipate the heat effectively using a large oil discharge outlet and forced discharge.

For machine tool spindle bearings, this method is used in some applications as a means for stable operation at ultra high speeds (see Fig. 6.3).

For the position of the spray nozzle, please refer to page 192.

Fig. 6.2 Recommended Oil Quantity for Each Bore Size of Bearing (Minimal Oil Quantity Lubrication)

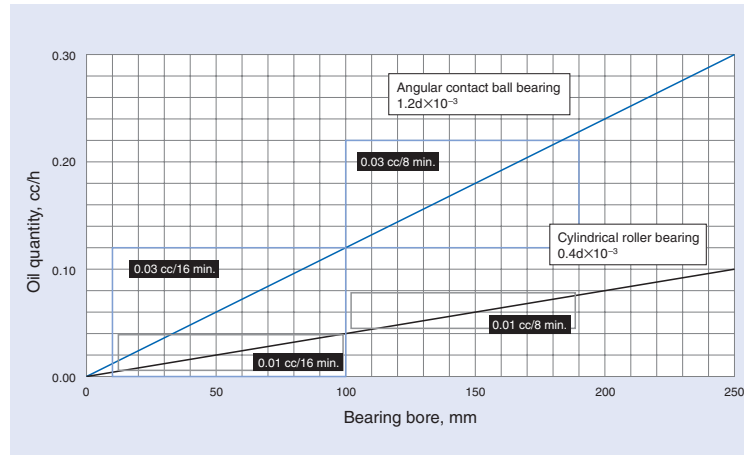
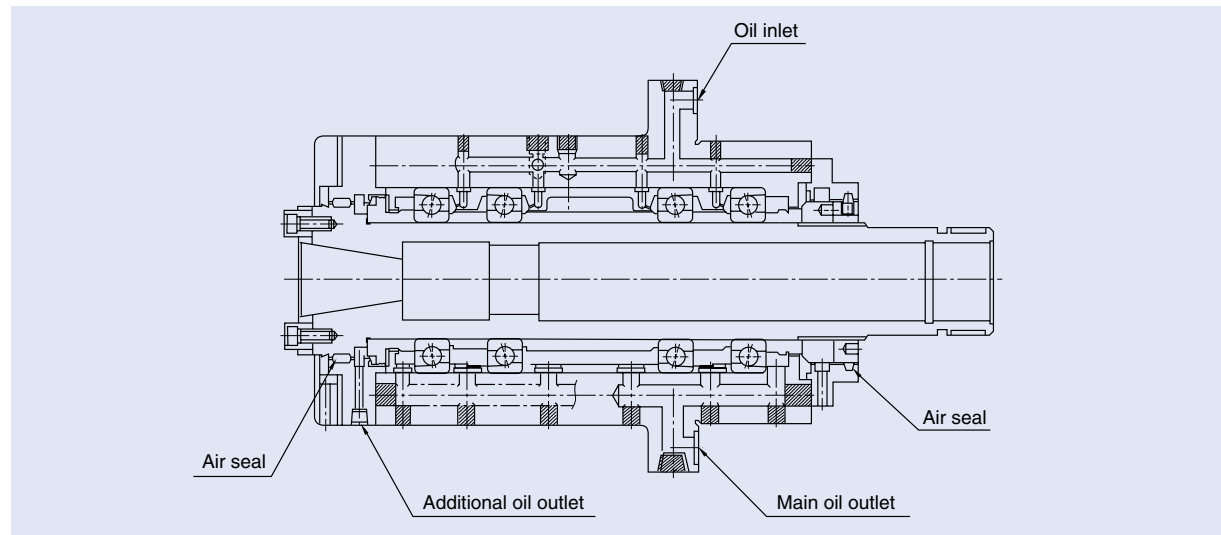

Fig. 6.3 Spindle Structure with Jet Lubrication



The Recommended Grease Quantities for High-speed Spindle Bearings

Unit: cc/bearing

Bore number	Bore diameter (mm)	Angular contact ball bearing : 15% of internal space				Cylindrical roller bearing : 10% of internal space			
		BNR19 BGR19 79xx	BGR10 70xx	BGR02 72xx	BNR10 BAR10 BTR10	NN49	NN39	NN30	N10
		X-quantity	X-quantity	X-quantity	X-quantity	X-quantity	X-quantity	X-quantity	X-quantity
5	5	-	-	0.03	-	-	-	-	-
6	6	-	0.04	0.07	-	-	-	-	-
7	7	-	0.07	-	-	-	-	-	-
8	8	-	0.12	0.10	-	-	-	-	-
00	10	0.06	0.13	0.16	-	-	-	-	-
01	12	0.06	0.14	0.23	-	-	-	-	-
02	15	0.11	0.18	0.29	-	-	-	-	-
03	17	0.13	0.24	0.41	-	-	-	-	-
04	20	0.23	0.44	0.68	-	-	-	-	-
05	25	0.27	0.52	0.85	-	-	-	0.4	-
06	30	0.31	0.69	1.2	0.58	-	-	0.6	0.4
07	35	0.48	0.98	1.7	0.78	-	-	0.8	0.6
08	40	0.75	1.2	2.1	0.92	-	-	1.0	0.7
09	45	0.83	1.5	2.6	1.2	-	-	1.3	1.0
10	50	0.91	1.6	3.0	1.2	-	-	1.4	1.1
11	55	1.1	2.4	3.9	1.7	-	-	2.0	1.5
12	60	1.2	2.6	4.8	1.8	-	-	2.1	1.6
13	65	1.3	2.6	5.7	1.9	-	-	2.2	1.6
14	70	2.1	3.6	6.5	2.8	-	-	3.2	2.4
15	75	2.3	3.6	7.0	2.9	-	-	3.5	2.5
16	80	2.4	5.1	8.7	3.8	-	-	4.7	3.5
17	85	3.5	5.3	11	4.0	-	-	4.9	3.7
18	90	3.6	6.6	13	5.5	-	-	6.5	4.5
19	95	3.6	6.8	16	5.7	-	-	6.6	4.7
20	100	4.9	7.2	19	6.1	5.4	4.5	6.8	4.9
21	105	5.1	9.0	23	7.6	5.6	4.6	9.3	5.9
22	110	5.2	12	27	9.1	5.7	4.8	11	7.5
24	120	7.9	12	31	9.8	8.4	6.5	12.5	8.1
26	130	9.0	18	34	15	11	8.5	18	12.4
28	140	9.9	20	42	17	12	9.3	20	12.9
30	150	14	25	53	22	24	14	23	-
32	160	16	34	-	26	20	15	29	-
34	170	14	42	-	33	21	15	38	-
36	180	22	51	-	46	28	23	51	-
38	190	27	47	-	50	30	24	54	-
40	200	39	76	-	61	44	35	69	-
44	220	42	-	-	-	-	37	-	-
48	240	41	-	-	-	-	40	-	-
52	260	77	-	-	-	-	70	-	-
56	280	80	-	-	-	-	75	-	-

The grease quantity of "xxTAC20(29)X(D)" should be same as the double row cylindrical roller bearing's, which is assembled with this bearing together. Use the grease listed on Page 173, and multiply 0.93 (density) to the quantity above, for the weight of the grease. For the recommended grease quantity for angular contact thrust ball bearing for ball screw support, please refer to Page 110-113.

Lubrication

7. BEARING TOLERANCES

The tolerance for the boundary dimensions and running accuracy of NSK radial bearings are specified by the Accuracies of Rolling Bearings in ISO 492/199/582/1132-1, and Rolling Bearing Tolerances in JIS B 1514. In addition to the above tolerances, NSK manufactures angular contact ball bearings with precision classes ABEC 5, 7, and 9 as specified by American Bearing Manufacturers Association (ABMA) Standard 20.

Rough definitions of the items listed for running accuracy and their measuring methods are described in Fig. 7.1 and Table 7.1. Further details are available in ISO 5593, Rolling Bearings Vocabulary in JIS B 0104, and Measuring Methods for Rolling Bearings in JIS B 1515.

Table 7.1

Running Accuracy	Inner Ring	Outer Ring	Dial Gauge
Radial runout of assembled bearing inner ring K_{ia}	Rotating	Stationary	A
Radial runout of assembled bearing outer ring K_{ea}	Stationary	Rotating	A
Assembled bearing inner ring face (backface) runout with raceway S_{ia}	Rotating	Stationary	B ₁
Assembled bearing outer ring face (backface) runout with raceway S_{ea}	Stationary	Rotating	B ₂
Inner ring reference face (backface, where applicable) runout with raceway S_d	Rotating	Stationary	C
Variation of bearing outside surface generatrix inclination with outer ring reference face (backface) S_D	N/A	Rotating	D

Tolerance for Radial Bearings

Inner Ring

Table 7.2 Inner Ring (Class 5)

Unit: μm

Nominal Bore Diameter d (mm)	Single Plane Mean Bore Dia. Deviation Δ_{dmp} (°)		Bore Dia. Variation in a Single Radial Plane V_{dp} (°)		Mean Bore Dia. Variation V_{dmp} (°)	Radial Runout of Inner Ring K_{ia}	Inner Ring Run out with Bore S_d	Inner Ring Face Runout with Raceway S_{ia} (*)	Deviation of Single Inner Ring Width Δ_{Bs}			Inner Ring Width Variation V_{Bs}	
			Diameter Series 9 0, 2, 3						Single Bearing Combined Bearing	Single Bearing	(*) Combined Bearing		
over	incl	high	low	max.	max.	max.	max.	max.				high	low
2.5	10	0	-5	5	4	3	4	7	7	0	-40	-250	5
10	18	0	-5	5	4	3	4	7	7	0	-80	-250	5
18	30	0	-6	6	5	3	4	8	8	0	-120	-250	5
30	50	0	-8	8	6	4	5	8	8	0	-120	-250	5
50	80	0	-9	9	7	5	5	8	8	0	-150	-250	6
80	120	0	-10	10	8	5	6	9	9	0	-200	-380	7
120	180	0	-13	13	10	7	8	10	10	0	-250	-380	8
180	250	0	-15	15	12	8	10	11	13	0	-300	-500	10
250	315	0	-18	18	14	9	13	13	15	0	-350	-500	13

Table 7.3 Inner Ring (Class 4)

Unit: μm

Nominal Bore Diameter d (mm)	Single plane mean bore dia. deviation Δ_{dmp} (°)		Deviation of a Single Bore Dia. Δ_{ds} (°)		Bore dia. Variation in a Single Radial Plane V_{dp} (°)		Mean Bore Dia. Variation V_{dmp} (°)	Radial Runout of Inner Ring K_{ia}	Inner Ring Runout with Bore S_d	Inner Ring Face Runout with Raceway S_{ia} (*)	Deviation of Single inner Ring Width Δ_{Bs}			Inner Ring Width Variation V_{Bs}	
			Diameter Series 9 0, 2, 3		Single Bearing Combined Bearing	Single Bearing					(*) Combined Bearing				
over	incl	high	low	high			low	max.	max.	max.		max.	max.	high	low
2.5	10	0	-4	0	-4	4	3	2	2.5	3	3	0	-40	-250	2.5
10	18	0	-4	0	-4	4	3	2	2.5	3	3	0	-80	-250	2.5
18	30	0	-5	0	-5	5	4	2.5	3	4	4	0	-120	-250	2.5
30	50	0	-6	0	-6	6	5	3	4	4	4	0	-120	-250	3
50	80	0	-7	0	-7	7	5	3.5	4	5	5	0	-150	-250	4
80	120	0	-8	0	-8	8	6	4	5	5	5	0	-200	-380	4
120	180	0	-10	0	-10	10	8	5	6	6	7	0	-250	-380	5
180	250	0	-12	0	-12	12	9	6	8	7	8	0	-300	-500	6

(°) Applicable to individual rings manufactured for combined bearings.

(*) Applicable to bearings with cylindrical bores.

(*) Class 3 is NSK's original accuracy. Tolerance of bearing bore diameter and outer ring diameter are Class 4. Other tolerances are Class 2.

(*) Applicable to ball bearings.

Remarks: 1. The cylindrical bore diameter tolerance limit (high), as per the no-go side of a plug gauge as specified in this table, is not necessarily applicable within a distance of 1.2 times the chamfer dimension r (max.) from the ring face.
 2. ABMA Standards ABEC5, ABEC7, and ABEC9 are equivalent to ISO (JIS) Classes 5, 4, and 2 respectively. ABMA Standards are applicable to angular contact ball bearings.

Fig. 7.1 Measuring Methods for Running Accuracy

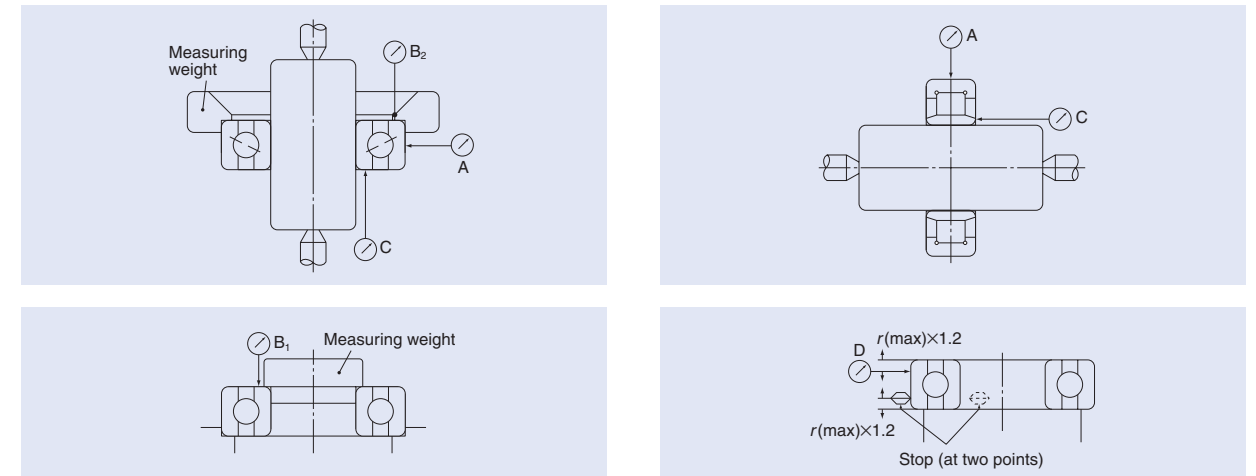

Table 7.4 Inner Ring (Class 3) (°)

Unit: μm

Nominal Bore Diameter d (mm)	Single Plane Mean Bore Dia. Deviation Δ_{dmp} (°)		Deviation of a Single Bore Dia. Δ_{ds} (°)		Bore Dia. Variation in a Single Radial Plane V_{dp} (°)	Mean Bore Dia. Variation V_{dmp} (°)	Radial Runout of Inner Ring K_{ia}	Inner Ring Runout with Bore S_d	Inner Ring Face Runout with Raceway S_{ia} (*)	Deviation of Single Inner Ring Width Δ_{Bs}			Inner Ring Width Variation V_{Bs}	
			Single Bearing Combined Bearing	Single Bearing						(*) Combined Bearing				
over	incl	high			low	high	low	max.	max.		max.	max.	max.	high
2.5	10	0	-4	0	-4	2.5	1.5	1.5	1.5	1.5	0	-40	-250	1.5
10	18	0	-4	0	-4	2.5	1.5	1.5	1.5	1.5	0	-80	-250	1.5
18	30	0	-5	0	-5	2.5	1.5	2.5	1.5	2.5	0	-120	-250	1.5
30	50	0	-6	0	-6	2.5	1.5	2.5	1.5	2.5	0	-120	-250	1.5
50	80	0	-7	0	-7	4	2	2.5	1.5	2.5	0	-150	-250	1.5
80	120	0	-8	0	-8	5	2.5	2.5	2.5	2.5	0	-200	-380	2.5
120	150	0	-10	0	-10	7	3.5	2.5	2.5	2.5	0	-250	-380	2.5
150	180	0	-10	0	-10	7	3.5	5	4	5	0	-250	-380	4
180	250	0	-12	0	-12	8	4	5	5	5	0	-300	-500	5

Table 7.5 Inner Ring (Class 2)

Unit: μm

Nominal Bore Diameter d (mm)	Single Plane Mean Bore Dia. Deviation Δ_{dmp} (°)		Deviation of a Single Bore Dia. Δ_{ds} (°)		Bore Dia. Variation in a Single Radial Plane V_{dp} (°)	Mean Bore Dia. Variation V_{dmp} (°)	Radial Runout of Inner Ring K_{ia}	Inner Ring Runout with Bore S_d	Inner Ring Face Runout with Raceway S_{ia} (*)	Deviation of Single Inner Ring Width Δ_{Bs}			Inner Ring Width Variation V_{Bs}	
			Single Bearing Combined Bearing	Single Bearing						(*) Combined Bearing				
over	incl	high			low	high	low	max.	max.		max.	max.	max.	high
2.5	10	0	-2.5	0	-2.5	2.5	1.5	1.5	1.5	1.5	0	-40	-250	1.5
10	18	0	-2.5	0	-2.5	2.5	1.5	1.5	1.5	1.5	0	-80	-250	1.5
18	30	0	-2.5	0	-2.5	2.5	1.5	2.5	1.5	2.5	0	-120	-250	1.5
30	50	0	-2.5	0	-2.5	2.5	1.5	2.5	1.5	2.5	0	-120	-250	1.5
50	80	0	-4	0	-4	4	2	2.5	1.5	2.5	0	-150	-250	1.5
80	120	0	-5	0	-5	5	2.5	2.5	2.5	2.5	0	-200	-380	2.5
120	150	0	-7	0	-7	7	3.5	2.5	2.5	2.5	0	-250	-380	2.5
150	180	0	-7	0	-7	7	3.5	5	4	5	0	-250	-380	4
180	250	0	-8	0	-8	8	4	5	5	5	0	-300	-500	5

Inner ring (Class 4Y)

(As for Class 4Y (P4Y), bore diameter dimensional accuracy and outside diameter dimensional accuracy are special.)

Table 7.6 Tolerance of Bore Diameter of Inner Ring Unit: μm

Bore diameter (mm)	Class 4		Class 4Y (Controlled to medium value)		
	over	incl	high	low	
30	50	0	-6	-1	-3
50	80	0	-7	-2	-5
80	120	0	-8	-3	-6
120	150	0	-10	-3	-7

* Tolerances for bearings under 30 mm bore are the same as values quoted for bearings with bores between 30-50 mm.

Class 4Y is NSK's proprietary accuracy standard, in which tolerance of a bearing bore diameter and an outer ring diameter are in a special class (controlled to medium value) and other tolerances are Class 4. Class 4Y has the same running accuracy as Class 4 but has a narrower tolerance range of bore and outer diameter than Class 4. It is suitable for universal combination bearings.

7. BEARING TOLERANCES

Tolerance for Radial Bearings

Outer Ring

Table 7.6 Outer Ring (Class 5)

Unit: μm

Nominal Outside Diameter D (mm)		Single Plane Mean Outside Dia. Deviation ΔD_{mp}		Outside Dia. Variation in a Single Radial Plane V_{DP}		Mean Outside Dia. Variation V_{Dmp}	Radial Runout of Outer Ring K_{ea}	Variation of Outside Surface Generatrix Inclination with Face S_D	Outer Ring Face Runout with Raceway $S_{ea}(^\circ)$	Deviation of Single Outer Ring Width ΔC_s	Outer Ring Width Variation V_{Cs}
				Diameter Series 9 0, 2							
over	incl	high	low	max.		max.	max.	max.	max.	Equal to the value of inner ring (ΔB_s) of the same bearing number.	max.
6	18	0	-5	5	4	3	5	8	8		5
18	30	0	-6	6	5	3	6	8	8		5
30	50	0	-7	7	5	4	7	8	8		5
50	80	0	-9	9	7	5	8	8	10		6
80	120	0	-10	10	8	5	10	9	11		8
120	150	0	-11	11	8	6	11	10	13		8
150	180	0	-13	13	10	7	13	10	14		8
180	250	0	-15	15	11	8	15	11	15		10
250	315	0	-18	18	14	9	18	13	18		11
315	400	0	-20	20	15	10	20	13	20		13

Table 7.7 Outer Ring (Class 4)

Unit: μm

Nominal Outside Diameter D (mm)		Single Plane Mean Outside Dia. Deviation ΔD_{mp}		Deviation of Single Outside Dia. ΔD_s		Outside Dia. Variation in a Single Radial Plane V_{DP}		Mean Outside Dia. Variation V_{Dmp}	Radial Runout of Outer Ring K_{ea}	Variation of Outside Surface Generatrix Inclination with Face S_D	Outer Ring Face Runout with Raceway $S_{ea}(^\circ)$	Deviation of Single Outer Ring Width ΔC_s	Outer Ring Width Variation V_{Cs}
				high	low	high	low						
over	incl	high	low	high	low	max.	max.	max.	max.	max.	max.	Equal to the value of inner ring (ΔB_s) of the same bearing number.	max.
6	18	0	-4	0	-4	4	3	2	3	4	5		2.5
18	30	0	-5	0	-5	5	4	2.5	4	4	5		2.5
30	50	0	-6	0	-6	6	5	3	5	4	5		2.5
50	80	0	-7	0	-7	7	5	3.5	5	4	5		3
80	120	0	-8	0	-8	8	6	4	6	5	6		4
120	150	0	-9	0	-9	9	7	5	7	5	7		5
150	180	0	-10	0	-10	10	8	5	8	5	8		5
180	250	0	-11	0	-11	11	8	6	10	7	10		7
250	315	0	-13	0	-13	13	10	7	11	8	10		7
315	400	0	-15	0	-15	15	11	8	13	10	13		8

(*) Applicable to ball bearings.

(†) Class 3 is NSK's original accuracy. Tolerance of bearing bore diameter and outer ring diameter are Class 4. Other tolerances are Class 2.

- Remarks:
- The cylindrical bore diameter tolerance limit (high), as per the no-go side of a plug gauge as specified in this table, is not necessarily applicable within a distance of 1.2 times the chamfer dimension r (max.) from the ring face.
 - ABMA Standards ABEC5, ABEC7, and ABEC9 are equivalent to ISO (JIS) Classes 5, 4, and 2 respectively. ABMA Standards are applicable to angular contact ball bearings.

Table 7.8 Outer Ring (Class 3)^(†)

Unit: μm

Nominal Outside Diameter D (mm)		Single Plane Mean Outside Dia. Deviation ΔD_{mp}		Deviation of Single Outside Dia. ΔD_s		Outside Dia. Variation in a Single Radial Plane V_{DP}	Mean Outside Dia. Variation V_{Dmp}	Radial Runout of Outer Ring K_{ea}	Variation of Outside Surface Generatrix Inclination with Face S_D	Outer Ring Face Runout with Raceway $S_{ea}(^\circ)$	Deviation of Single Outer Ring Width ΔC_s	Outer Ring Width Variation V_{Cs}
				high	low							
over	incl	high	low	high	low	max.	max.	max.	max.	max.	Equal to the value of inner ring (ΔB_s) of the same bearing number.	max.
6	18	0	-4	0	-4	2.5	1.5	1.5	1.5	1.5		1.5
18	30	0	-5	0	-5	4	2	2.5	1.5	2.5		1.5
30	50	0	-6	0	-6	4	2	2.5	1.5	2.5		1.5
50	80	0	-7	0	-7	4	2	4	1.5	4		1.5
80	120	0	-8	0	-8	5	2.5	5	2.5	5		2.5
120	150	0	-9	0	-9	5	2.5	5	2.5	5		2.5
150	180	0	-10	0	-10	7	3.5	5	2.5	5		2.5
180	250	0	-11	0	-11	8	4	7	4	7		4
250	315	0	-13	0	-13	8	4	7	5	7		5
315	400	0	-15	0	-15	10	5	8	7	8		7

Table 7.9 Outer Ring (Class 2)

Unit: μm

Nominal Outside Diameter D (mm)		Single Plane Mean Outside Dia. Deviation ΔD_{mp}		Deviation of Single Outside Dia. ΔD_s		Outside Dia. Variation in a Single Radial Plane V_{DP}	Mean Outside Dia. Variation V_{Dmp}	Radial Runout of Outer Ring K_{ea}	Variation of Outside Surface Generatrix Inclination with Face S_D	Outer Ring Face Runout with Raceway $S_{ea}(^\circ)$	Deviation of Single Outer Ring Width ΔC_s	Outer Ring Width Variation V_{Cs}
				high	low							
over	incl	high	low	high	low	max.	max.	max.	max.	max.	Equal to the value of inner ring (ΔB_s) of the same bearing number.	max.
6	18	0	-2.5	0	-2.5	2.5	1.5	1.5	1.5	1.5		1.5
18	30	0	-4	0	-4	4	2	2.5	1.5	2.5		1.5
30	50	0	-4	0	-4	4	2	2.5	1.5	2.5		1.5
50	80	0	-4	0	-4	4	2	4	1.5	4		1.5
80	120	0	-5	0	-5	5	2.5	5	2.5	5		2.5
120	150	0	-5	0	-5	5	2.5	5	2.5	5		2.5
150	180	0	-7	0	-7	7	3.5	5	2.5	5		2.5
180	250	0	-8	0	-8	8	4	7	4	7		4
250	315	0	-8	0	-8	8	4	7	5	7		5
315	400	0	-10	0	-10	10	5	8	7	8		7

Outer ring (Class 4Y)

Table 7.11 Tolerance of Outer Diameter of Outer Ring Unit: μm

Outer diameter (mm)		Class 4		Class 4Y (Controlled to medium value)	
		high	low	high	low
over	incl	high	low	high	low
50	80	0	-7	-2	-6
80	120	0	-8	-2	-6
120	150	0	-9	-3	-7
150	180	0	-10	-3	-7
180	200	0	-11	-4	-9
200	215 and less	0	-11	-2	-9

* Tolerances for bearings under 50 mm outer diameter are the same as values quoted for bearings with outer diameters between 50–80 mm. Class 4Y is NSK's proprietary accuracy standard in which tolerance of a bearing bore diameter and an outer ring diameter are in a special class (controlled to medium value) and other tolerances are Class 4. Class 4Y has the same running accuracy as Class 4 but has a narrower tolerance range of bore and outer diameter than Class 4. It is suitable for universal combination bearings.

Tolerances for Tapered Bores of Cylindrical Roller Bearings

Tolerances for Tapered Bores

The bore accuracy of tapered bore cylindrical roller bearings is specified by ISO. However, in this standard, the tolerances are rather wide. For precision-class cylindrical roller bearings, NSK established its own narrower tolerances. As is customary, however, two taper angles are available within the tolerance range specified by ISO (see Fig. 7.2).

(NSK terminated production of K tapered bore cylindrical roller bearings and is producing only KR tapered bore cylindrical roller bearings.)

Fig. 7.2 Tolerances

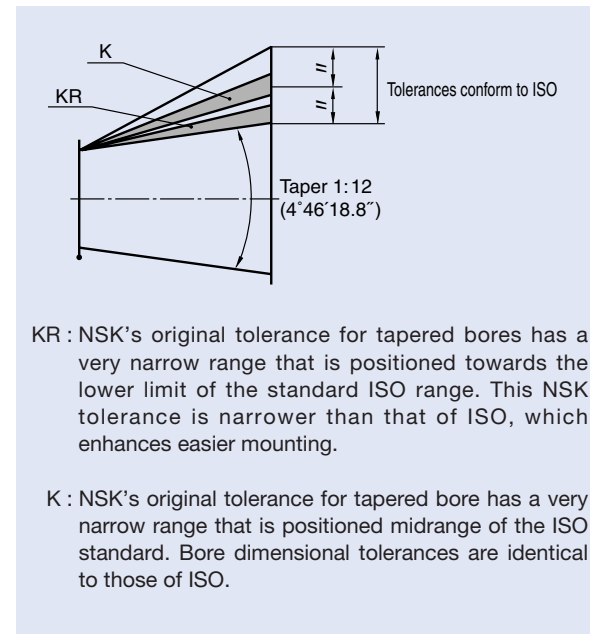

Fig. 7.3 Tapered Bore Tolerances

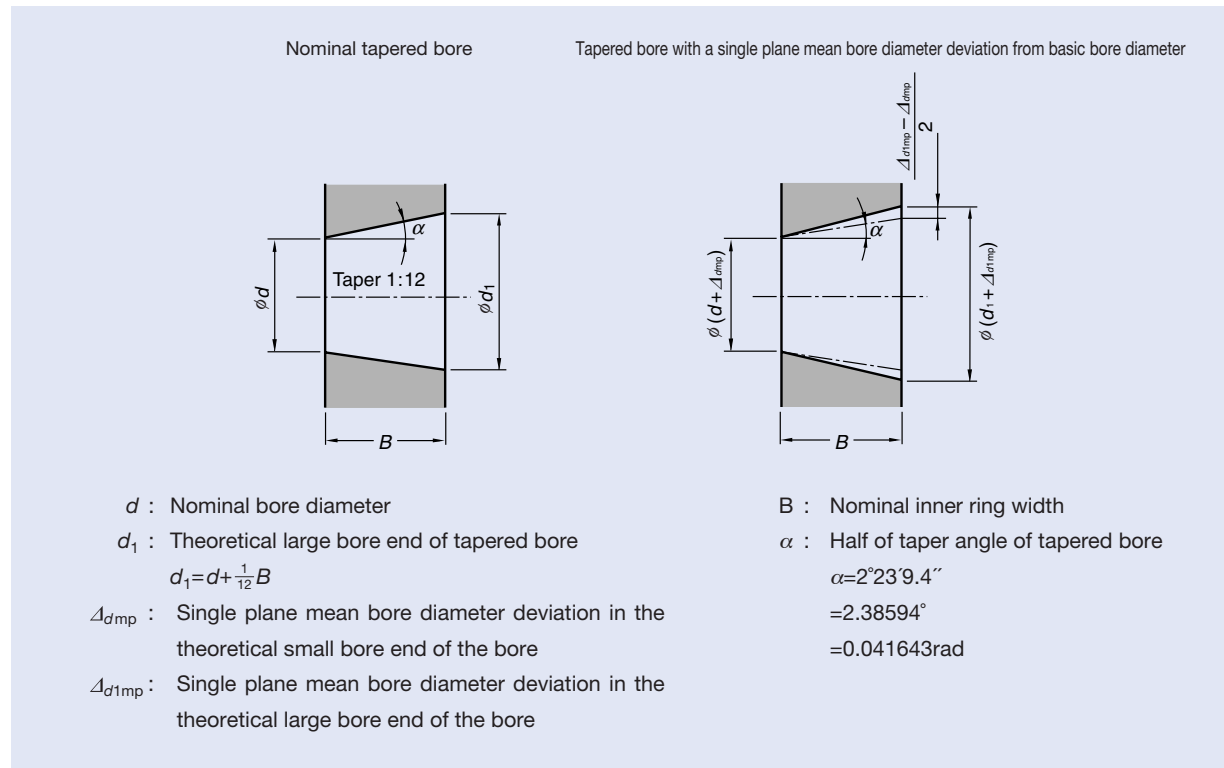

Table 7.10 KR Tapered Bores

d (mm)		Δd_{mp}		(Reference) ⁽²⁾ $\Delta d_{1mp} - \Delta d_{mp}$		$V_{ap}^{(1)}$
over	incl	high	low	high	low	max.
18	30	+13	0	+3	0	4
30	50	+16	0	+3	0	5
50	80	+19	0	+4	0	6
80	120	+22	0	+5	0	7
120	180	+25	0	+7	0	9
180	250	+29	0	+9	0	12

⁽¹⁾ Bore diameter variation in a single radial plane, which is applicable to all radial planes of tapered bores.

⁽²⁾ Taper angular tolerance, $4^\circ 46' 18.8'' \pm 25''$

Table 7.11 K Tapered Bores

d (mm)		Δd_{mp}		$\Delta d_{1mp} - \Delta d_{mp}$		$V_{ap}^{(1)}$
over	incl	high	low	high	low	max.
18	30	+21	0	+21	0	4
30	50	+25	0	+25	0	5
50	80	+30	0	+30	0	6
80	120	+35	0	+35	0	7
120	180	+40	0	+40	0	9
180	250	+46	0	+46	0	12
250	315	+52	0	+52	0	14
315	400	+57	0	+57	0	16
400	500	+63	0	+63	0	18

⁽¹⁾ Bore diameter variation in a single radial plane, which is applicable to all radial planes of tapered bores.

Tolerances for Angular Contact Thrust Ball Bearings

Tolerances for high speed angular contact thrust ball bearing (Class 4A⁽¹⁾) of BAR and BTR types

Table 7.14 Inner ring Unit: μm

Nominal Bore Diameter d (mm)	Single Plane Mean Bore Dia. Deviation Δ_{dmp}		Deviation of a Single Bore Dia. Δ_{ds}		Bore Dia. Variation in a Single Radial Plane V_{dp}		Mean Bore Dia. Variation V_{dmp}	Radial Runout of Inner Ring K_{ia}	Inner Ring Runout with Bore S_d	Inner Ring Face Runout with Raceway S_{ia}	Inner Ring Width Variation V_{Bs}	Deviation of Single Inner Ring Width $\Delta_{Bs} (\Delta_{Cs})$			
	over	incl	high	low	high	low						Diameter Series		high	low
												9	0		
–	50	0	– 6	0	– 6	6	5	3	4	4	4	3	0	– 300	
50	80	0	– 7	0	– 7	7	5	3.5	4	5	5	4	0	– 500	
80	120	0	– 8	0	– 8	8	6	4	5	5	5	4	0	– 500	
120	150	0	– 10	0	– 10	10	8	5	6	6	7	5	0	– 750	
150	180	0	– 10	0	– 10	10	8	5	6	6	7	5	0	– 750	
180	250	0	– 12	0	– 12	12	9	6	8	7	8	6	0	– 1 000	

Table 7.15 Outer ring Unit: μm

Nominal Outside Diameter D (mm)	Single Plane Mean Outside Dia. Deviation Δ_{Dmp}		Deviation of Single Outside Dia. Δ_{Ds}		Outside Dia. Variation in a Single Radial Plane V_{Dp}		Mean Outside Dia. Variation V_{Dmp}	Radial Runout of Outer Ring K_{ea}	Variation of Outside Surface Generatrix Inclination with Face S_D	Outer Ring Face Runout with Raceway S_{ea}	Outer Ring Width Variation V_{Cs}		
	over	incl	high	low	high	low						Diameter Series	
												9	0
–	80	– 30	– 37	– 30	– 37	7	5	3.5	5	4	5	3	
80	120	– 40	– 48	– 40	– 48	8	6	4	6	5	6	4	
120	150	– 50	– 59	– 50	– 59	9	7	5	7	5	7	5	
150	180	– 50	– 60	– 50	– 60	10	8	5	8	5	8	5	
180	250	– 50	– 61	– 50	– 61	11	8	6	10	7	10	7	
250	315	– 60	– 73	– 60	– 73	13	10	7	11	8	10	7	

⁽¹⁾ NSK specification. Equivalent to ISO Class 4 except for tolerance of outer ring outside diameter.

Tolerances for double direction angular contact thrust ball bearing (Class 7⁽²⁾) of TAC type

Table 7.16 Tolerances of inner ring, outer ring, and bearing height

Nominal Bore Diameter d (mm)	Deviation of a Single Bore Diameter Δ_{ds}		Deviation of the Actual Bearing Height Δ_{Ts}		Radial Runout of Assembled Bearing Inner Ring (Outer Ring) $K_{ia} (K_{ea})$	Inner Ring Runout with Bore S_d	Inner ring (Outer Ring) Face Runout with Raceway $S_{ia} (S_{ea})$	
	over	incl	high	low				max.
–	30	0	– 5	0	– 300	5	4	3
30	50	0	– 5	0	– 400	5	4	3
50	80	0	– 8	0	– 500	6	5	5
80	120	0	– 8	0	– 600	6	5	5
120	180	0	– 10	0	– 700	8	8	5
180	250	0	– 13	0	– 800	8	8	6
250	315	0	– 15	0	– 900	10	10	6
315	400	0	– 18	0	– 1200	10	12	7

⁽²⁾ NSK specification

Table 7.17 Tolerance of outer ring

Nominal Outside Diameter D (mm)	Deviation of Single Outside Dia. Δ_{Ds}	
	over	incl
30	50	– 25
50	80	– 30
80	120	– 36
120	180	– 43
180	250	– 50
250	315	– 56
315	400	– 62
400	500	– 68
500	630	– 76

Tolerances for Angular Contact Ball Bearing for Ball Screw Support

Machine Tool Applications

Table 7.18 TAC B series Unit: μm

Nominal Bore or Outside Diameter (mm)	Deviation of Bore Diameter				Deviation of Outside Diameter				Deviation of Inner Ring Width		Inner or Outer Ring Runout with Raceway Tolerance Classes	
	Tolerance Classes				Tolerance Classes				Tolerance Classes			
	PN7A		PN7B		PN7A		PN7B		PN7A	PN7B		
over	incl	high	low	high	low	high	low	high	low	high	low	max.
10	18	0	– 4	0	– 4	–	–	–	–	0	– 120	2.5
18	30	0	– 5	0	– 4	–	–	–	–	0	– 120	2.5
30	50	0	– 6	0	– 4	0	– 6	0	– 4	0	– 120	2.5
50	80	0	– 7	0	– 5	0	– 7	0	– 5	0	– 150	2.5
80	120	0	– 8	0	– 6	0	– 8	0	– 6	0	– 200	2.5

Remark: Variation of outer ring width is the same as that for the inner ring of the same bearing.

Class PN7A is the standard tolerance for these bearings. This corresponds to ISO Class 4 for radial ball bearings, but for the runout of the inner and outer rings, more stringent values are applied.

The stricter Class PN7B applies to the dimensional tolerances of the bores and outside diameters of single-row universal arrangement bearings (SU).

Electrical Injection Molding Machine

Table 7.19 TAC 02 and 03 series Unit: μm

Nominal Bore or Outside Diameter (mm)	Deviation of Bore Diameter		Deviation of Outside Diameter		Deviation of Inner Ring Width		Inner or Outer Ring Runout with Raceway	
	Tolerance Class							
	PN5D							
over	incl	high	low	high	low	high	low	max.
10	18	0	– 5	–	–	0	– 80	5
18	30	0	– 6	–	–	0	– 120	5
30	50	0	– 8	0	– 7	0	– 120	5
50	80	0	– 9	0	– 9	0	– 150	8
80	120	0	– 10	0	– 10	0	– 200	8
120	150	–	–	0	– 11	–	–	–
150	180	–	–	0	– 13	–	–	–
180	250	–	–	0	– 15	–	–	–
250	315	–	–	0	– 18	–	–	–

Remark: Variation of outer ring width is the same as that for the inner ring of the same bearing.

Class PN5D is the standard tolerance for these bearings. This corresponds to ISO Class 5 for radial ball bearings, but for the runout of the inner and outer rings, more stringent values are applied.

8. DESIGN OF SHAFTS AND HOUSINGS

Fitting of Shafts and Housings

It is of utmost importance that shafts and housings are accurately and precisely mated in order to take full advantage of the precision bearings' capabilities, which include rotational accuracy, high speed performance, and low heat generation.

When the inner ring or outer ring is mounted onto a shaft or into a housing with some interference, the shape of shaft or housing (out of roundness) is transferred to the bearing raceway surfaces and affects running accuracy. When multiple angular contact ball bearings are used, cylindricity affects the distribution of preload for each bearing. Therefore, the mating parts should be as accurate as possible.

Inaccurate mating of parts can cause the formation of peaks or ridges along the shaft of a precision lathe, which can affect the quality of finished work.

Table 8.1 Fits on Shafts (°)

Bearing Type	Shaft Outer Diameter (mm)		Tolerance of Shaft (°) Outer Diameter (mm)		Target Interference (°) (°) (mm)	
	over	incl	min.	max.	min.	max.
Machine tool spindle bearing (°)	10	18	-0.003	0	0	0.002 T
	18	50	-0.004	0	0	0.0025T
	50	80	-0.005	0	0	0.003 T
	80	120	-0.003	0.003	0	0.004 T
	120	180	-0.004	0.004	0	0.004 T
180	250	-0.005	0.005	0	0.005 T	
Angular contact thrust ball bearing for ball screw support	10	18	-0.008	0	-	-
	18	30	-0.009	0	-	-
	30	50	-0.011	0	-	-
	50	80	-0.013	0	-	-
80	120	-0.015	0	-	-	

Table 8.2 Fits on Housings (°)

Bearing Type	Housing Bore Diameter (mm)		Tolerance of Housing (°) Bore Diameter (mm)		Target Clearance (°) (°) (mm)	
	over	incl	min.	max.	min.	max.
Angular contact ball bearing (Fixed end)	18	50	-0.002	0.002	0.002L	0.006L
	50	80	-0.0025	0.0025	0.002L	0.006L
	80	120	-0.003	0.003	0.003L	0.008L
	120	180	-0.004	0.004	0.003L	0.008L
	180	250	-0.005	0.005	0.005L	0.010L
Angular contact ball bearing (Free end)	18	50	0	0.004	0.006L	0.011L
	50	80	0	0.005	0.006L	0.011L
	80	120	0	0.006	0.009L	0.015L
	120	180	0	0.008	0.009L	0.015L
180	250	0	0.010	0.015L	0.022L	
Cylindrical roller bearing	18	50	-0.006	0	0.002L	0.002T
	50	80	-0.007	0	0.002L	0.002T
	80	120	-0.008	0	0.002L	0.002T
	120	180	-0.009	0	0.002L	0.002T
180	250	-0.011	0	0.002L	0.002T	
Angular contact thrust ball bearing for ball screw support	10	18	-	-	-	-
	18	30	-	-	-	-
	30	50	0	0.016	-	-
	50	80	0	0.019	-	-
80	120	0	0.022	-	-	

(°) The fitting data above provides general recommendations for machine tool spindles operating under normal conditions and for $d_m n$ values of less than 800,000. For high speeds, heavy loads, or outer ring rotation, please contact NSK for assistance.

(°) Use the target interference when the bearing can be matched to the shaft or housing. Otherwise, use the shaft outer diameter and housing bore minimum and maximum for random matching.

(°) Applies to angular contact ball bearings: 70XX, 79XX, 72XX, BNR and BER

Angular contact thrust ball bearings: BAR, BTR and TAC

Cylindrical rollers bearings: N10XX, NN30XX, NN39XX, NN49XX and NNU49XX.

(°) T=Interference or tight fit

L=Clearance or loose fit

If the taper of the inner ring for a double row cylindrical roller bearing with a tapered bore does not match that of the shaft, the residual clearance will be different for two of the rows. Therefore, load will not be sustained normally, and will impair rigidity or cause irregular movement of the rollers due to taper of the inner ring groove. We recommend that you gauge the tapered parts to be mated with bearings. Contact should cover more than 80% of the total surface area that is dyed blue. The recommended accuracy and surface roughness of bearing mounting seats are shown in following tables:

Table 8.3 Tolerance for and Mean Roughness of Shafts

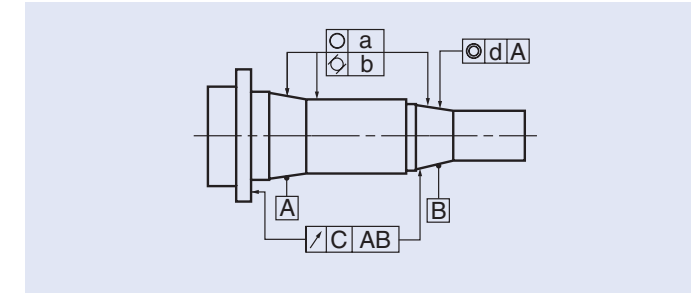

Shaft Diameter (mm)		Tolerance Grades and Mean Roughness (µm)									
		Out-of-roundness (○)		Cylindricity (⊂)		Runout (⊖)		Coaxiality (⊙)		Roughness	
over	incl	a		b		c		d		R _a	
		Bearing Accuracy		Bearing Accuracy		Bearing Accuracy		Bearing Accuracy		Bearing Accuracy	
		P5, P4	P3, P2	P5, P4	P3, P2	P5, P4	P3, P2	P5, P4	P3, P2	P5, P4	P3, P2
-	10	0.7	0.5	0.7	0.5	2	1.2	4	2.5	0.2	0.1
10	18	1	0.6	1	0.6	2.5	1.5	5	3	0.2	0.1
18	30	1.2	0.7	1.2	0.7	3	2	6	4	0.2	0.1
30	50	1.2	0.7	1.2	0.7	3.5	2	7	4	0.2	0.1
50	80	1.5	1	1.5	1	4	2.5	8	5	0.2	0.1
80	120	2	1.2	2	1.2	5	3	10	6	0.4	0.2
120	180	2.5	1.7	2.5	1.7	6	4	12	8	0.4	0.2
180	250	3.5	2.2	3.5	2.2	7	5	14	10	0.4	0.2
250	315	4	3	4	3	8	6	16	12	0.4	0.2

Table 8.4 Tolerance for and Mean Roughness of Housings

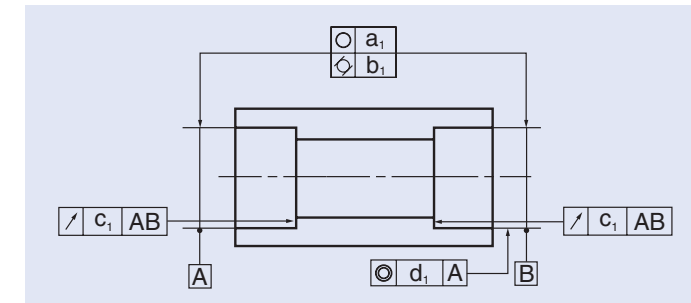

Housing Bore Diameter (mm)		Tolerance Grades and Mean Roughness (µm)									
		Out-of-roundness (○)		Cylindricity (⊂)		Runout (⊖)		Coaxiality (⊙)		Roughness	
over	incl	a ₁		b ₁		c ₁		d ₁		R _a	
		Bearing Accuracy		Bearing Accuracy		Bearing Accuracy		Bearing Accuracy		Bearing Accuracy	
		P5, P4	P3, P2	P5, P4	P3, P2	P5, P4	P3, P2	P5, P4	P3, P2	P5, P4	P3, P2
10	18	1	0.6	1	0.6	2.5	1.5	5	3	0.4	0.2
18	30	1.2	0.7	1.2	0.7	3	2	6	4	0.4	0.2
30	50	1.2	0.7	1.2	0.7	3.5	2	7	4	0.4	0.2
50	80	1.5	1	1.5	1	4	2.5	8	5	0.4	0.2
80	120	2	1.2	2	1.2	5	3	10	6	0.8	0.4
120	180	2.5	1.7	2.5	1.7	6	4	12	8	0.8	0.4
180	250	3.5	2.2	3.5	2.2	7	5	14	10	0.8	0.4
250	315	4	3	4	3	8	6	16	12	1.6	0.8
315	400	4.5	3.5	4.5	3.5	9	6.5	18	13	1.6	0.8

Shoulder and Fillet Dimensions

Table 8.5 Shoulder and Fillet Dimensions for Angular Contact Ball Bearings

Unit: mm

Nominal Bore Diameter	Dimension Series 19 79XX, BNR19, BER19, BAR19, BTR19, BGR19, TAC29X					Dimension Series 10 70XX, BNR10, BER10, BAR10, BTR10, BGR10, TAC20X					Dimension Series 02 72XX, BGR02				
	d_a (min.)	D_a (max.)	D_b (max.)	r_a (max.)	r_b (max.)	d_a (min.)	D_a (max.)	D_b (max.)	r_a (max.)	r_b (max.)	d_a (min.)	D_a (max.)	D_b (max.)	r_a (max.)	r_b (max.)
5	-	-	-	-	-	-	-	-	-	-	7.5	13.5	-	0.3	-
6	-	-	-	-	-	8.5	14.5	-	0.3	-	8.5	16.5	-	0.3	-
7	-	-	-	-	-	9.5	16.5	-	0.3	-	-	-	-	-	-
8	-	-	-	-	-	10.5	19.5	-	0.3	-	10.5	21.5	-	0.3	-
10	12.5	19.5	20.8	0.3	0.15	12.5	23.5	24.8	0.3	0.15	15	25	27.5	0.6	0.3
12	14.5	21.5	22.8	0.3	0.15	14.5	25.5	26.8	0.3	0.15	17	27	29.5	0.6	0.3
15	17.5	25.5	26.8	0.3	0.15	17.5	29.5	30.8	0.3	0.15	20	30	32.5	0.6	0.3
17	19.5	27.5	28.8	0.3	0.15	19.5	32.5	33.8	0.3	0.15	22	35	37.5	0.6	0.3
20	22.5	34.5	35.8	0.3	0.15	25	37	39.5	0.6	0.3	26	41	42	1.0	0.5
25	27.5	39.5	40.8	0.3	0.15	30	42	44.5	0.6	0.3	31	46	47	1.0	0.5
30	32.5	44.5	45.8	0.3	0.15	36	49	50	1.0	0.5	36	56	57	1.0	0.5
35	40	50	52.5	0.6	0.3	41	56	57	1.0	0.5	42	65	67	1.0	0.6
40	45	57	59.5	0.6	0.3	46	62	63	1.0	0.5	47	73	75	1.0	0.6
45	50	63	65.5	0.6	0.3	51	69	70	1.0	0.5	52	78	80	1.0	0.6
50	55	67	69.5	0.6	0.3	56	74	75	1.0	0.5	57	83	85	1.0	0.6
55	61	74	75	1.0	0.5	62	83	85	1.0	0.6	64	91	94	1.5	0.8
60	66	79	80	1.0	0.5	67	88	90	1.0	0.6	69	101	104	1.5	0.8
65	71	84	85	1.0	0.5	72	93	95	1.0	0.6	74	111	114	1.5	0.8
70	76	94	95	1.0	0.5	77	103	105	1.0	0.6	79	116	119	1.5	0.8
75	81	99	100	1.0	0.5	82	108	110	1.0	0.6	84	121	124	1.5	0.8
80	86	104	105	1.0	0.5	87	118	120	1.0	0.6	90	130	134	2.0	1.0
85	92	113	115	1.0	0.6	92	123	125	1.0	0.6	95	140	144	2.0	1.0
90	97	118	120	1.0	0.6	99	131	134	1.5	0.8	100	150	154	2.0	1.0
95	102	123	125	1.0	0.6	104	136	139	1.5	0.8	107	158	163	2.0	1.0
100	107	133	135	1.0	0.6	109	141	144	1.5	0.8	112	168	173	2.0	1.0
105	112	138	140	1.0	0.6	115	150	154	2.0	1.0	117	178	183	2.0	1.0
110	117	143	145	1.0	0.6	120	160	164	2.0	1.0	122	188	193	2.0	1.0
120	127	158	160	1.0	0.6	130	170	174	2.0	1.0	132	203	208	2.0	1.0
130	139	171	174	1.5	0.8	140	190	194	2.0	1.0	144	216	223	2.5	1.0
140	149	181	184	1.5	0.8	150	200	204	2.0	1.0	154	236	243	2.5	1.0
150	160	200	204	2.0	1.0	162	213	218	2.0	1.0	164	256	263	2.5	1.0
160	170	210	214	2.0	1.0	172	228	233	2.0	1.0	174	276	283	2.5	1.0
170	180	220	224	2.0	1.0	182	248	253	2.0	1.0	188	292	301	3.0	1.5
180	190	240	244	2.0	1.0	192	268	273	2.0	1.0	198	302	311	3.0	1.5
190	200	250	254	2.0	1.0	202	278	283	2.0	1.0	208	322	331	3.0	1.5
200	212	268	273	2.0	1.0	212	298	303	2.0	1.0	218	342	351	3.0	1.5
220	242	282	287	2.0	1.0	-	-	-	-	-	-	-	-	-	-
240	263	301	306	2.0	1.0	-	-	-	-	-	-	-	-	-	-
260	283	341	345	2.0	1.0	-	-	-	-	-	-	-	-	-	-
280	304	360	365	2.0	1.0	-	-	-	-	-	-	-	-	-	-

Table 8.6 Shoulder and Fillet Dimension for Cylindrical Roller Bearings

Unit: mm

Nominal Bore Diameter	Dimension Series 19 NN39, NN49, NNU49						Dimension Series 10 (Double row) NN30XX					Dimension Series 10 (Single row) N10XX				
	d_a (min.)	d_{1a} (min.)	d_c (min.)	D_a (max.)	r_a (max.)	r_b (max.)	d_a (min.)	d_{1a} (min.)	D_a (max.)	r_a (max.)	r_b (max.)	d_a (min.)	d_{1a} (min.)	D_a (max.)	r_a (max.)	r_b (max.)
25	-	-	-	-	-	-	29	29	43	42	0.6	-	-	-	-	-
30	-	-	-	-	-	-	35	36	50	50	1.0	35	36	51	49	0.5
35	-	-	-	-	-	-	40	41	57	56	1.0	40	41	57	56	0.5
40	-	-	-	-	-	-	45	46	63	62	1.0	45	46	63	62	0.6
45	-	-	-	-	-	-	50	51	70	69	1.0	50	51	70	69	0.6
50	-	-	-	-	-	-	55	56	75	74	1.0	55	56	75	74	0.6
55	-	-	-	-	-	-	61.5	62	83.5	83	1.0	61.5	61	83.5	83	1.0
60	-	-	-	-	-	-	66.5	67	88.5	88	1.0	66.5	66	88.5	88	1.0
65	-	-	-	-	-	-	71.5	72	93.5	93	1.0	71.5	71	93.5	93	1.0
70	-	-	-	-	-	-	76.5	77	103.5	102	1.0	76.5	76	103.5	102	1.0
75	-	-	-	-	-	-	81.5	82	108.5	107	1.0	81.5	81	108.5	107	1.0
80	-	-	-	-	-	-	86.5	87	118.5	115	1.0	86.5	86	118.5	115	1.0
85	-	-	-	-	-	-	91.5	92	123.5	120	1.0	91.5	91	123.5	120	1.0
90	-	-	-	-	-	-	98	99	132	129	1.5	98	97	132	129	1.0
95	-	-	-	-	-	-	103	104	137	134	1.5	103	102	137	134	1.0
100	106.5	108	115	133.5	131	1.0	108	109	142	139	1.5	108	107	142	139	1.0
105	111.5	113	120	138.5	136	1.0	114	115	151	148	2.0	114	114	151	148	1.0
110	116.5	118	125	143.5	141	1.0	119	121	161	157	2.0	119	119	161	157	1.0
120	126.5	128	137	158.5	154.5	1.0	129	131	171	167	2.0	129	129	171	167	1.0
130	138	140	148	172	169	1.5	139	141	191	185	2.0	139	140	191	185	1.0
140	148	150	158	182	180	1.5	149	151	201	195	2.0	149	150	203.5	194	1.0
150	159	162	171	201	197	2.0	161	162	214	209	2.0	-	-	-	-	-
160	169	172	182	211	207	2.0	171	172	229	222	2.0	-	-	-	-	-
170	179	182	192	221	217	2.0	181	183	249	239	2.0	-	-	-	-	-
180	189	193	205	241	234	2.0	191	193	269	258	2.0	-	-	-	-	-
190	199	203	217	251	245.5	2.0	201	203	279	268	2.0	-	-	-	-	-
200	211	214	228	269	261	2.0	211	214	299	285	2.0	-	-	-	-	-
220	231	234	-	289	281	2.0	-	-	-	-	-	-	-	-	-	-
240	251	254	-	309	302	2.0	-	-	-	-	-	-	-	-	-	-
260	271	275	-	349	338	2.0	-	-	-	-	-	-	-	-	-	-
280	291	295	-	369	358	2.0	-	-	-	-	-	-	-	-	-	-

Fig. 8.1 Figure of Shoulder and Fillet Dimension

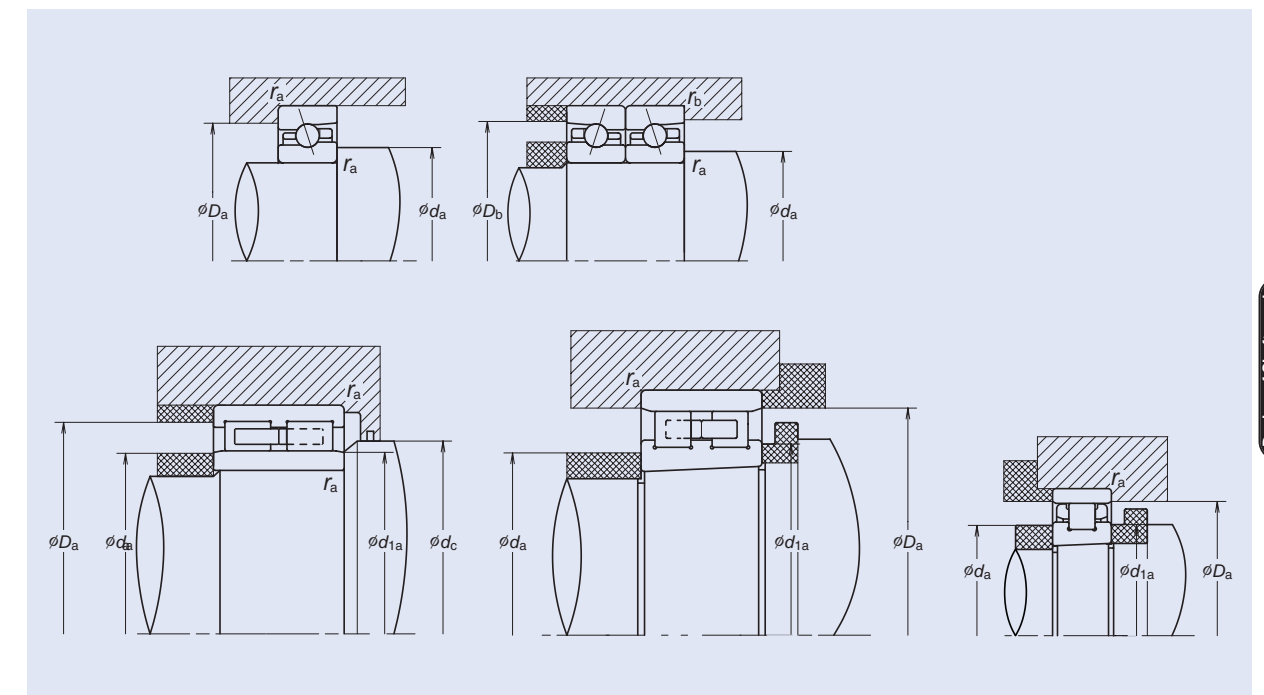

Chamfer Dimension Limits and Corner Radius of Shaft or Housing

Fig. 8.2 Chamfer Dimension

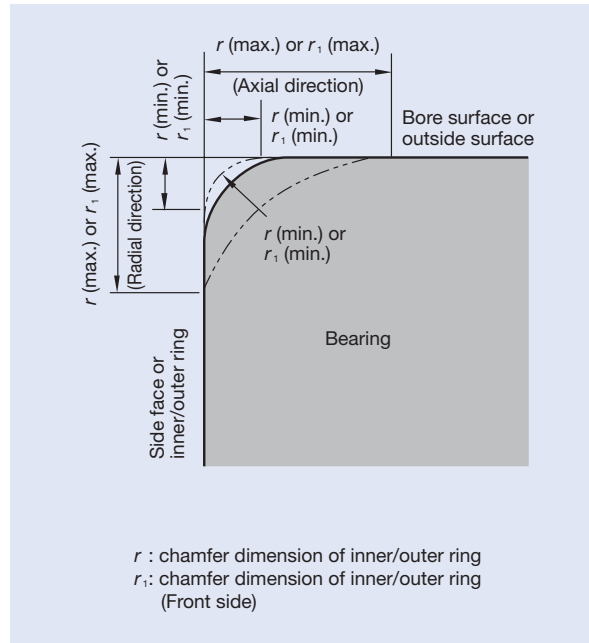

Remarks: The precise shape of chamfer surfaces has not been specified but its profile in the axial plane shall not intersect an arc of radius r (min.) or r_1 (min.) touching the side face of an inner ring and bore surface, or the side face of an outer ring and outside surface.

Table 8.7 Chamfer Dimension Limits Unit: mm

Permissible Chamfer Dimension for Inner/Outer Rings r (min.) or r_1 (min.)	Nominal Bore Diameter d		Permissible Chamfer Dimension for Inner/Outer Rings r (max.) or r_1 (max.)		Reference Corner Radius of Shaft or Housing r_a
	over	incl	Radial Direction	Axial Direction (1)	
0.05	—	—	0.1	0.2	0.05
0.08	—	—	0.16	0.3	0.08
0.1	—	—	0.2	0.4	0.1
0.15	—	—	0.3	0.6	0.15
0.2	—	—	0.5	0.8	0.2
0.3	—	40	0.6	1	0.3
0.3	40	—	0.8	1	0.3
0.6	—	40	1	2	0.6
0.6	40	—	1.3	2	0.6
1	—	50	1.5	3	1
1	50	—	1.9	3	1
1.1	—	120	2	3.5	1
1.1	120	—	2.5	4	1
1.5	—	120	2.3	4	1.5
1.5	120	—	3	5	1.5

Unit: mm

Permissible Chamfer Dimension for Inner/Outer Rings r (min.) or r_1 (min.)	Nominal Bore Diameter d		Permissible Chamfer Dimension for Inner/Outer Rings r (max.) or r_1 (max.)		Reference Corner Radius of Shaft or Housing r_a
	over	incl	Radial Direction	Axial Direction (1)	
2	—	80	3	4.5	2
2	80	220	3.5	5	2
2	220	—	3.8	6	2
2.1	—	280	4	6.5	2
2.1	280	—	4.5	7	2
2.5	—	100	3.8	6	2
2.5	100	280	4.5	6	2
2.5	280	—	5	7	2
3	—	280	5	8	2.5
3	280	—	5.5	8	2.5
4	—	—	6.5	9	3
5	—	—	8	10	4
6	—	—	10	13	5
7.5	—	—	12.5	17	6
9.5	—	—	15	19	8
12	—	—	18	24	10
15	—	—	21	30	12
19	—	—	25	38	15

(1) For bearings with nominal widths less than 2 mm, the value of r (max) in the axial direction is the same as that in the radial direction.

Spacer Dimensions

The dimensions of standard spacers for angular contact ball bearings (19, 29, 10, 20 and 02 series) are listed below:

Additional information:

Material of spacer: Steel (SUI2) or S** C steel

When using spacers, parallelism of spacer end surfaces should be less than 0.003 mm.

19 or 29 Series Standard Spacers for Dimension Series 19 or 29 (79, BNR19, BER19, BNR29, BER29, BGR19) Unit: mm

Bore Numbers	Nominal Bore Diameter	Outer Diameter	Outer Ring Spacer		Inner Ring Spacer		Spacer Chamfer
			Outer Diameter (1)	Bore	Outer Diameter	Bore (2)	
00	10	22	21.5	17.5	14.5	10.5	0.2
01	12	24	23.5	19.5	16.5	12.5	0.2
02	15	28	27.5	23.5	19.5	15.5	0.2
03	17	30	29.5	25.5	21.5	17.5	0.2
04	20	37	36.5	31.5	26	20.5	0.2
05	25	42	41.5	36	31	25.5	0.2
06	30	47	46.5	41	36	30.5	0.2
07	35	55	54.5	48	42	35.5	0.3
08	40	62	61.5	54.5	47.5	40.5	0.3
09	45	68	67.5	60	53	45.5	0.3
10	50	72	71.5	66	56	50.5	0.3
11	55	80	79.5	72	64	55.5	0.5
12	60	85	84.5	77	68	60.5	0.5
13	65	90	89.5	82	73	65.5	0.5
14	70	100	99.5	91.5	79	70.5	0.5
15	75	105	104.5	96.5	84	75.5	0.5
16	80	110	109.5	101.5	89.5	80.5	0.5
17	85	120	119.5	110	95	85.5	0.5
18	90	125	124.2	116	100	90.5	0.5
19	95	130	129.2	120	106	95.5	0.5
20	100	140	139.2	129	112	100.5	0.5
21	105	145	144.2	133	117	105.5	0.5
22	110	150	149.2	138	122	110.5	0.5
24	120	165	164.2	152	133	120.5	0.5
26	130	180	179.2	166	144	130.8	0.8
28	140	190	189.2	176	154	140.8	0.8
30	150	210	209.2	193	167	150.8	1.0
32	160	220	219.2	213	175	160.8	1.0
34	170	230	229.2	214	188	170.8	1.0
36	180	250	249.2	231	200	180.8	1.0
38	190	260	259.2	242	206	190.8	1.0
40	200	280	279.2	255	225	200.8	1.0

(1) For outer ring spacers operating under oil mist lubrication or jet lubrication, the outer diameter of the outer ring spacer is the same as that of the bearing outside diameter. Recommend maintaining a tolerance of g5 or better.

(2) For high speed operations exceeding a value of $d_{mn} 70 \times 10^4$, the bore diameter of the inner ring spacer is the same as that of the bearing bore. Recommend maintaining a tolerance of F6 or better.

Additional information:

Material of spacer: Steel (SUJ2) or S ** C steel

When using spacers, parallelism of spacer end surfaces should be less than 0.003 mm.

10 or 20 Series

Standard spacers for dimension series 10 or 20 (70, BNR10, BER10, BNR20, BER20, BGR10) Unit: mm

Bore Numbers	Nominal Bore Diameter	Outer Diameter	Outer Ring Spacer		Inner Ring Spacer		Spacer Chamfer
			Outer Diameter (¹)	Bore	Outer Diameter	Bore (²)	
00	10	26	25.5	21.5	14.5	10.5	0.2
01	12	28	27.5	23.5	17	12.5	0.2
02	15	32	31.5	27	20	15.5	0.2
03	17	35	34.5	29.5	23	17.5	0.2
04	20	42	41.5	35	27	20.5	0.3
05	25	47	46.5	40.5	32	25.5	0.3
06	30	55	54.5	47.5	38	30.5	0.5
07	35	62	61.5	54	43	35.5	0.5
08	40	68	67.5	60	48	40.5	0.5
09	45	75	74.5	66	55	45.5	0.5
10	50	80	79.5	71	60	50.5	0.5
11	55	90	89.5	81	66	55.5	0.5
12	60	95	94.5	86	69	60.5	0.5
13	65	100	99.5	91	74	65.5	0.5
14	70	110	109.5	98	83	70.5	0.5
15	75	115	114.5	105	85	75.5	0.5
16	80	125	124.2	112	93	80.5	0.5
17	85	130	129.2	117	99	85.5	0.5
18	90	140	139.2	126	104	90.5	0.8
19	95	145	144.2	131	109	95.5	0.8
20	100	150	149.2	136	114	100.5	0.8
21	105	160	159.2	144	121	105.5	1.0
22	110	170	169.2	153	128	110.5	1.0
24	120	180	179.2	166	136	120.5	1.0
26	130	200	199.2	177	150	130.8	1.0
28	140	210	209.2	190	160	140.8	1.0
30	150	225	224.2	203	172	150.8	1.2
32	160	240	239.2	217	183	160.8	1.2
34	170	260	259.2	230.5	199.5	170.8	1.2
36	180	280	279.2	250	210	180.8	1.2
38	190	290	289.2	261	221	190.8	1.2
40	200	310	309.2	278	232	200.8	1.2

(¹) For outer ring spacers operating under oil mist lubrication or jet lubrication, the outer diameter of the outer ring spacer is the same as that of the bearing outside diameter. Recommend maintaining a tolerance of g5 or better.

(²) For high speed operations exceeding a value of $d_{m}n$ 70×10^4 , the bore diameter of the inner ring spacer is the same as that of the bearing bore. Recommend maintaining a tolerance of F6 or better.

02 Series

Standard spacers for dimension series 02 (72, BGR02) Unit: mm

Bore Numbers	Nominal Bore Diameter	Outer Diameter	Outer Ring Spacer		Inner Ring Spacer		Spacer Chamfer
			Outer Diameter (¹)	Bore	Outer Diameter	Bore (²)	
00	10	30	29.5	25	17	10.5	0.3
01	12	32	31.5	27	18	12.5	0.3
02	15	35	34.5	29	21	15.5	0.3
03	17	40	39.5	33	24	17.5	0.3
04	20	47	46.5	39	28	20.5	0.5
05	25	52	51.5	44	33	25.5	0.5
06	30	62	61.5	53	40	30.5	0.5
07	35	72	71.5	62	46	35.5	0.5
08	40	80	79.5	68	52	40.5	0.5
09	45	85	84.5	75	56	45.5	0.5
10	50	90	89.5	80	60	50.5	0.5
11	55	100	99.5	90	65	55.5	0.8
12	60	110	109.5	95	75	60.5	0.8
13	65	120	119.5	105	80	65.5	0.8
14	70	125	124.2	110	85	70.5	0.8
15	75	130	129.2	115	90	75.5	0.8
16	80	140	139.2	125	95	80.5	1.0
17	85	150	149.2	135	105	85.5	1.0
18	90	160	159.2	140	110	90.5	1.0
19	95	170	169.2	150	115	95.5	1.0
20	100	180	179.2	160	125	100.5	1.0
21	105	190	189.2	170	132	105.5	1.0
22	110	200	199.2	175	135	110.5	1.0
24	120	215	214.2	190	145	120.5	1.0
26	130	230	229.2	203	157	130.8	1.2
28	140	250	249.2	220	170	140.8	1.2
30	150	270	269.2	233	189	150.8	1.2

(¹) For outer ring spacers operating under oil mist lubrication or jet lubrication, the outer diameter of the outer ring spacer is the same as that of the bearing outside diameter. Recommend maintaining a tolerance of g5 or better.

(²) For high speed operations exceeding a value of $d_{m}n$ 70×10^4 , the bore diameter of the inner ring spacer is the same as that of the bearing bore. Recommend maintaining a tolerance of F6 or better.

Position of the Spray Nozzle

The following table lists positions of a spray nozzle for oil-air, oil mist, and oil jet lubricating systems.

Unit: mm

Bore Numbers	Nominal Bearing Bore	79 Series		70 Series		72 Series		N10XXMR (Standard series)		N10XXR (ROBUST series)	
		ϕA (°)	B	ϕA (°)	B	ϕA (°)	B	ϕA	B	ϕA	B
00	10	14.5	0.4	16.1	0.5	18.1	0.5	-	-	-	-
01	12	16.5	0.4	18.3	0.5	19.6	0.5	-	-	-	-
02	15	20.0	0.5	21.3	0.5	22.6	0.7	-	-	-	-
03	17	21.8	0.5	23.5	1.0	25.9	0.7	-	-	-	-
04	20	26.1	0.5	28.2	1.0	30.5	1.0	-	-	-	-
05	25	31.1	0.5	32.9	1.0	35.5	1.0	-	-	-	-
06	30	36.1	0.5	39.5	1.0	42.4	1.0	39.7	1.2	-	-
07	35	42.6	0.5	44.6	1.0	49.2	0.7	45.4	1.5	-	-
08	40	47.9	0.5	50.0	1.0	55.5	0.7	50.6	1.5	-	-
09	45	53.4	0.5	55.6	1.0	60.2	0.7	56.5	2.0	60.0	0.6
10	50	57.9	0.5	60.6	1.0	65.2	1.0	61.5	2.0	64.5	1.3
11	55	64.0	0.5	67.3	1.0	72.0	1.0	69.2	2.5	71.0	1.2
12	60	69.0	0.5	72.5	1.0	79.0	0.7	74.3	2.5	76.5	1.2
13	65	74.0	0.5	77.5	1.0	86.2	0.7	79.2	2.5	81.5	1.2
14	70	80.9	0.7	83.7	1.0	90.9	0.7	86.6	3.0	89.0	1.5
15	75	85.5	0.7	89.4	1.0	95.9	0.7	90.0	2.5	94.5	1.5
16	80	90.5	0.7	96.5	1.0	102.8	0.7	98.5	3.0	101.0	2.0
17	85	98.8	0.7	101.5	1.0	109.8	1.0	103.5	3.0	106.0	2.0
18	90	102.8	0.7	108.6	1.0	116.7	1.0	109.0	3.0	-	-
19	95	107.7	0.7	113.3	1.0	123.6	1.0	115.5	2.5	-	-
20	100	116.0	0.7	118.6	1.0	130.6	1.0	119.0	2.5	-	-
21	105	119.5	0.7	125.1	0.7	137.4	1.0	125.5	3.0	-	-
22	110	124.5	0.7	131.9	0.7	144.4	1.0	134.0	3.0	-	-
24	120	136.3	0.7	142.3	0.7	156.3	1.0	142.0	3.0	-	-
26	130	149.3	0.7	156.2	1.0	168.9	1.0	156.0	4.5	-	-
28	140	158.1	0.7	165.7	2.5	182.6	1.0	168.0	4.5	-	-
30	150	171.8	0.7	178.1	2.5	196.5	1.0	-	-	-	-
32	160	181.8	0.7	190.4	2.5	-	-	-	-	-	-
34	170	191.8	0.7	203.4	2.5	-	-	-	-	-	-
36	180	205.6	0.7	217.1	2.5	-	-	-	-	-	-
38	190	215.4	0.7	227.1	2.5	-	-	-	-	-	-
40	200	229.0	0.7	240.9	2.5	-	-	-	-	-	-

(°) In compliance with DIN Standard 628-6.

Attention

- For bearings operating under normal operating speed, proper lubrication can be achieved by positioning the nozzle bore along the side of the bearing and aiming directly into the bearing interior at the level of the inner ring. For constant high speed operations, it is advantageous to position the nozzle bore so that the lubricant is directed into the bearing interior at an angle of about 15° or 20°. Please contact NSK for further details.
- An appropriate means of draining oil sump is necessary to prevent severe oil shear friction, which can result in bearing damage at the sliding section.
- Recommend using a maximum 5 micron filter to provide filtration of oil entering the lubricating system.

Fig. 9.1 Angle of nozzle

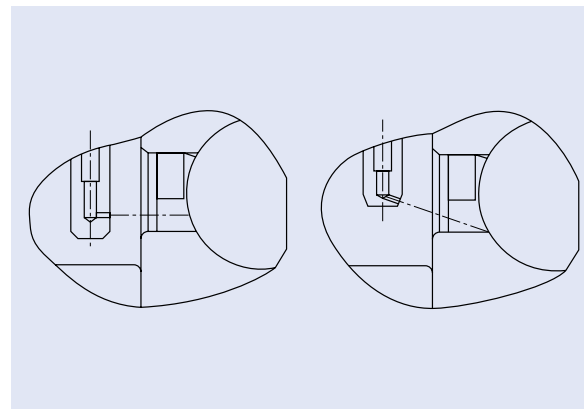

Unit: mm

Nominal Bearing Bore	BNR19 BER19		BNR10 BER10		BGR19		BGR10		BGR02		BAR10 BTR10	
	ϕA	B	ϕA	B	ϕA	B	ϕA	B	ϕA	B	ϕA	B
6	-	-	-	-	-	-	9.0	0.4	-	-	-	-
7	-	-	-	-	-	-	10.5	0.4	-	-	-	-
8	-	-	-	-	-	-	12.0	0.5	-	-	-	-
10	-	-	-	-	13.5	0.4	14.5	0.5	17.0	1.0	-	-
12	-	-	-	-	15.5	0.4	16.5	0.5	18.0	0.5	-	-
15	-	-	-	-	18.5	0.5	20.0	1.0	21.0	1.0	-	-
17	-	-	-	-	20.5	0.5	22.5	1.5	24.0	0.5	-	-
20	-	-	-	-	25.0	0.8	26.5	0.8	28.3	0.5	-	-
25	31.0	0.5	-	-	30.0	0.8	31.5	0.8	33.2	1.0	-	-
30	35.5	0.5	39.0	1.0	-	-	-	-	-	-	-	-
35	42.0	0.5	44.5	1.2	-	-	-	-	-	-	-	-
40	48.0	0.5	50.0	1.5	-	-	-	-	-	-	-	-
45	53.0	0.5	55.5	1.7	-	-	-	-	-	-	-	-
50	57.5	0.5	60.5	1.7	-	-	-	-	-	-	60.5	0.9
55	63.5	0.5	67.5	1.5	-	-	-	-	-	-	67.5	0.7
60	68.5	0.5	73.0	1.5	-	-	-	-	-	-	73.5	0.7
65	73.5	0.5	77.5	1.5	-	-	-	-	-	-	77.5	0.7
70	80.5	0.7	84.0	1.7	-	-	-	-	-	-	84.0	0.7
75	85.0	0.7	89.0	1.7	-	-	-	-	-	-	89.0	0.7
80	90.5	0.7	96.0	1.7	-	-	-	-	-	-	96.0	0.9
85	98.5	0.7	102.0	1.7	-	-	-	-	-	-	102.0	0.9
90	102.0	0.7	109.0	1.7	-	-	-	-	-	-	108.5	1.2
95	107.0	0.7	112.0	1.7	-	-	-	-	-	-	112.5	1.2
100	113.5	0.7	118.5	2.5	-	-	-	-	-	-	118.5	1.7
105	119.0	0.7	125.0	1.7	-	-	-	-	-	-	126.0	1.4
110	124.0	0.7	132.5	1.7	-	-	-	-	-	-	132.5	1.2
120	136.0	0.7	143.0	1.7	-	-	-	-	-	-	142.5	1.2
130	149.0	0.7	156.5	1.7	-	-	-	-	-	-	155.5	1.7
140	157.5	0.7	166.0	1.7	-	-	-	-	-	-	167	1.7
150	171.5	0.7	178.5	1.7	-	-	-	-	-	-	179.5	1.9
160	-	-	-	-	-	-	-	-	-	-	190	2.0
170	-	-	-	-	-	-	-	-	-	-	205	1.7
180	-	-	-	-	-	-	-	-	-	-	218	2.0
190	-	-	-	-	-	-	-	-	-	-	228	2.0
200	-	-	-	-	-	-	-	-	-	-	242	2.2

Fig. 9.2 Position and Direction of Spray Nozzle

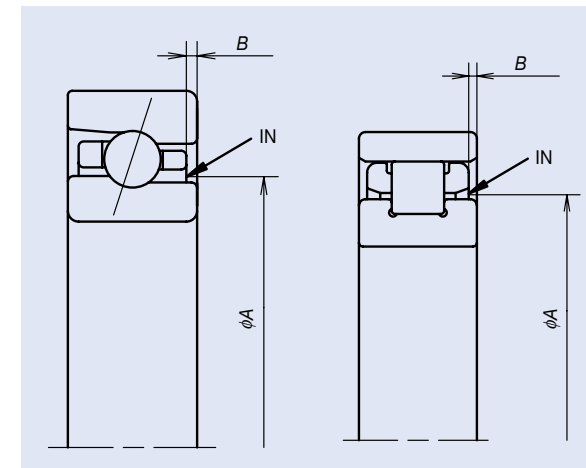



Bearing Handling

- 1. MountingP196-209
 - 1. Cleaning the Bearings and Related Parts
 - 2. Checking Dimensions of Related Parts
 - 3. Mounting Procedures
 - 4. Inspection after Mounting
- 2. Operating InspectionP210-211
- 3. Initial Running-in ProceduresP212-213

Mounting

Operating Inspection

Initial Running-in Procedures

Bearing Handling

Introduction

Mounting Procedure

The method of mounting rolling bearings strongly affects their accuracy, life, and performance. It is recommended that the handling procedures for bearings be fully analyzed by designers and engineers and that standards be established with respect to following items:

1. Cleaning the bearings and related parts
2. Checking the dimensions of related parts
3. Mounting procedures
4. Inspection after mounting

Bearings should not be unpacked until immediately before mounting. However, bearings for instruments or for high speed operations must first be cleaned with clean filtered oil in order to remove the anti-corrosion agent.

After the bearings are cleaned with filtered oil, they should be protected to prevent corrosion. Prelubricated bearings must be used without cleaning.

Bearing mounting procedures vary according to the type of bearing and type of fit.

Since precision bearings are widely used for rotating shafts, their inner rings require a tight fit.

Bearings with cylindrical bores are usually mounted by fitting with a press (press fit), or by heating them to expand their inner ring (shrink fit). The outer ring is usually inserted into the housing with a loose fit. In case where the outer ring has an interference fit, a press may be used.

Precautions for Proper Handling of Bearings

Since rolling bearings are high precision machine parts, they must be handled accordingly.

Even if high quality bearings are used, their expected performance cannot be achieved if they are not handled properly. The main precautions to be observed are as follows:

■ Keep bearings and surrounding area clean

Foreign particles, even if invisible to the naked eye, have harmful effects on bearings. Take care to prevent the entry of dirt and debris into the bearing by maintaining a clean working environment.

■ Handle bearings carefully

Avoid any heavy shocks during handling. Shock loads can scratch or otherwise damage a bearing, possibly resulting in failure. An excessively strong impact may cause brinelling, breakage, or cracks.

■ Use proper tools

Always use the proper equipment when handling bearing. Do not use general purpose tools.

■ Prevent corrosion

Handling bearings with bare hands can corrode the bearing surfaces because of the acidic moisture or other contaminations on the hands.

Keep your hands clean when handling bearings, and wear dust free gloves whenever possible. Take measures to prevent rusting of bearings caused by moisture and corrosive gasses.

Storage method

■ Although bearings are coated with an anti-corrosion agent, and then wrapped and packed, it is impossible to completely avoid exposure to the air surrounding the bearings. Store the bearings in a dry location and avoid exposure to moisture and humidity.

■ Bearings should be stored in a clean, dry, and well-ventilated location that also provides protection from direct sunlight. Store the bearings in a locker or on shelves that are at least 30 cm from the floor.

■ When bearings are unpacked for acceptance inspection, take measures to prevent rusting and contamination. After inspection, follow the guidelines given above to ensure proper storage.

1. Cleaning the Bearings and Related Parts

Delivered bearings are coated with an anti-corrosion agent for dustproofing and rust prevention during transportation.

After opening the package, bearings need to be cleaned in order to remove the anti-corrosion agent.

Some bearings, such as sealed or pregreased bearings, can be used without cleaning.

■ Cleaning method ■

1. Use kerosene or light oil to clean the bearings.
2. Use separate tanks for rough cleaning and final cleaning. Each tank should be equipped with a wire rack to prevent direct contact of the bearing with any contamination that may have settled at the bottom.
3. In the rough cleaning tank, avoid rotating the bearings. After cleaning the outside surfaces with a brush, move the bearings to the final cleaning tank.
4. In the final cleaning tank rotate the bearing by hand. Make sure that the cleaning fluid in the final cleaning tank is kept clean.
5. Remove excess cleaning fluid from the bearings after cleaning. Bearings using ordinary grease lubrication need to be packed with grease. Oil lubricated bearings should be mounted on the machine tool spindle while taking care not to rotate the bearing. Prior to mounting, slightly coat the bearing inner and outer surface areas with a thin film of lubrication oil.

2. Checking Dimension of Related Parts

Inspection of shaft and housing

- Mating housing and shaft surfaces should be cleaned and checked for flows or burrs.
- The dimensions of the shafts and housing bores should be checked to confirm a matching fit with the bearing bore and outer diameter. Recommended fits for shafts and housing bores are listed on Page 184.
- Take measurements and mount the bearings in a thermostatic chamber. Parts should be left until they have

reached a constant and stable temperature. Using a micrometer or cylinder gauge, take measurements at several different points to confirm there are no significant differences in measurement values. Recommended measurements for accuracy of the shafts and housing bores are listed on Page 185.

Inspection of spacers

For main spindle, a spacer parallelism of less than 0.003 mm is recommended. Spacer parallelism exceeding this recommendation will tilt the bearings, thus causing inaccuracies and bearing noise.

3. Mounting Procedures

Grease lubricated bearings and oil-air (oil mist) lubricated bearings which are cleaned are mounted on the shaft and housing bore. Procedures for mounting vary according to the fit requirements of the inner and outer rings. Primarily, it is the inner ring of a machine tool bearing that rotates, thus bearings with cylindrical bores are usually mounted by heating them to expand the inner ring (shrink fit).

Bearing with tapered bores can be mounted directly onto a tapered shaft. For high speed operations, GN gauges are recommended for attaining accurate radial clearance when mounting. Page 202 provides details on how to use GN gauges.

Outer rings are mounted with some clearance; so mounting tool are not usually required. The housing can be heated to make mounting much easier.

3.1. Mounting of Bearings with Cylindrical Bores

(1) Press fit

Fitting with a press is widely used for small bearings. First, apply a thin coat of oil to the mating shaft surface before mounting to help reduce the amount of force required for press fitting.

Next, place a mounting tool against the inner rings as shown in Fig. 1.1. Apply steady pressure from the mounting tool to drive the bearing firmly against the shoulder of the shaft.

Avoid press fitting onto a shaft by applying pressure to the outer rings as this may damage the bearing.

Also, avoid using a hammer when mounting precision bearings.

For separable bearings, such as cylindrical roller bearings, the inner and outer rings can be mounted onto the shaft and into the housing as separate units. When assembling the two units, take extra care to align the inner and outer rings correctly. Careless or forced assembly may cause scratches on the rolling contact surfaces.

(2) Shrink fit

Since press fitting large bearings requires a great deal of force, the shrink fitting method is widely used. The bearings are first heated to expand the inner ring before mounting onto the shaft. This method prevents excessive force from being imposed on the bearings and enables mounting them in a short time.

The expansion of the inner ring for various temperature differences and bearing sizes is shown in Fig. 1.2.

The following precautions need to be taken when shrink fitting.

1. Do not heat bearings to more than 120°C.
2. Heat the bearings to a temperature 20°C to 30°C higher than the lowest temperature required for mounting without interference since the inner ring will cool a little during mounting.
3. After mounting, the bearings will shrink in the axial direction as well as the radial direction while cooling. Therefore, drive the bearing firmly up against the shaft shoulder using locating methods to eliminate any clearance between the bearing and shoulder.

3.2. Precautions for Mounting Angular Contact Ball Bearings

Due to design restriction, an angular contact ball bearing can sustain loads in only one direction. Therefore, when mounting angular contact ball bearings onto the shaft or into the housing, it is important not to apply any load in the wrong direction.

Pay special attention to the order of mounting for combination bearings. Mounting onto the shaft and into the housing is different for Back-to-back and Face-to-face arrangements.

Fig. 1.3 Direction of Load for Angular Contact Ball Bearings

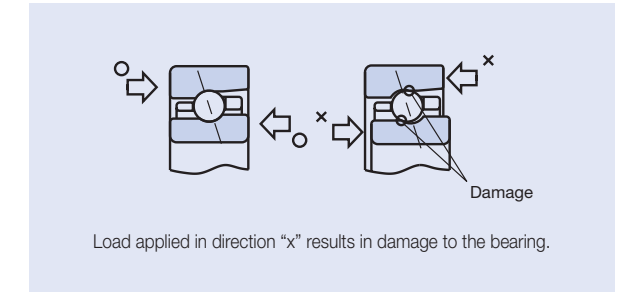

Back-to-back arrangement:

- ① Press the bearing onto the shaft.
- ② Tighten the bearing locknut for preloading.
- ③ Insert the bearing and the shaft into the housing, and attach the retaining cover.

Face-to-face arrangement:

- ① Press the bearing into the housing.
- ② Secure the retaining cover for preloading.
- ③ Insert the shaft into the inner ring and tighten the bearing locknut.

Fig. 1.4 Mounting of Back-to-back Arrangement

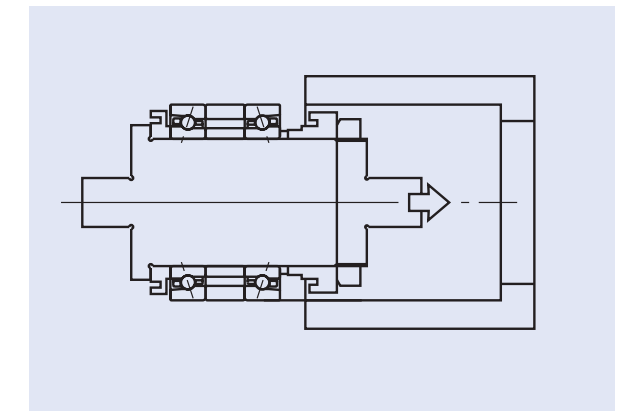

Fig. 1.5 Mounting of Face-to-face Arrangement

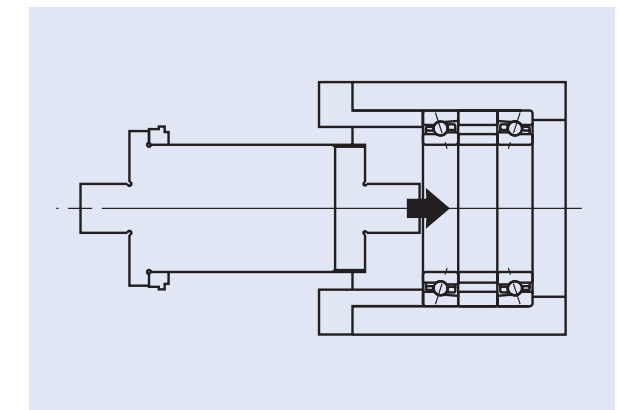

Fig. 1.1 Press Fitting Inner Ring

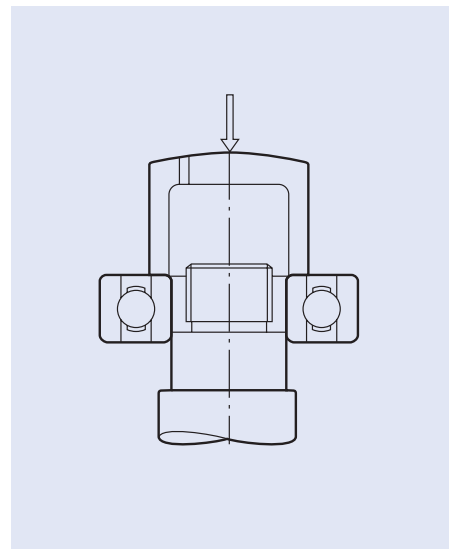
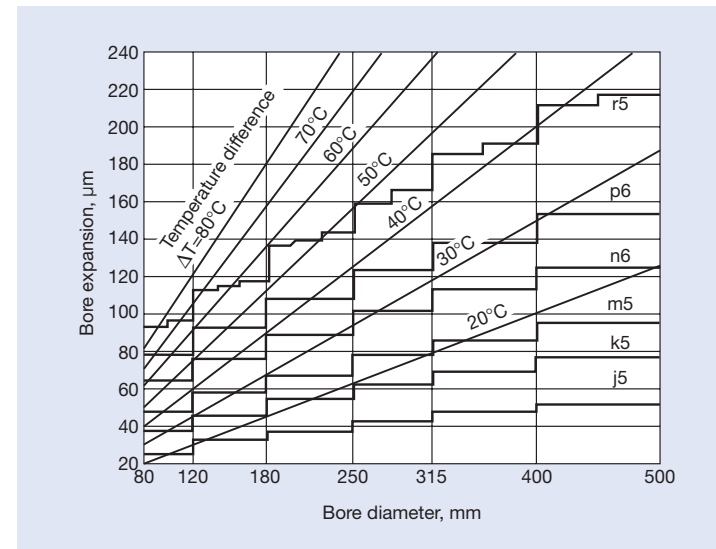

Fig. 1.2 Temperature and Thermal Expansion of Inner Ring



Reverse the order of each step for dismounting.

3.3. Securing the bearing (1) Securing the inner ring

The inner ring is usually secured onto the shaft by tightening the bearing locknut, which explains why perpendicularity of the threads and end face are very important. Even if accuracy as a single component is good, the gap between the shaft and locknut can result in runout of the locknut, causing the shaft and bearing to bend (see Fig. 1.21, Page 207). Therefore, making adjustments are necessary to ensure constant running accuracy.

It is also important that the locknut be completely tightened so as to eliminate any possibility of it becoming loose. Seating torque information for bearing locknuts is shown in Table 1.1.

There is a risk of unbalance due to face and runout of the locknut or a minor inaccuracy of the mating parts. Here, sleeves are widely used in high speed, high precision machine tool spindles to secure the bearing to the shaft by a large interference fit between the shaft and sleeve bore. However, the sleeve tends to become loose after continuous operation, so it must be checked periodically.

When a wide spacer is used between combined angular contact ball bearings, and the seating torque of the locknut is excessive, the inner ring spacer may become deformed and alter the preload to a level higher than expected. It is necessary to consider this deformation when the preload is set.

(2) Securing the outer ring

A retaining cover held by bolts is generally used to secure the bearing outer ring axially. If a bolt is tightened excessively or a combination of bolts is tightened unevenly, the bearing outer ring may become deformed.

For example, Fig. 1.6 shows possible deformation of the outer diameter of the outer ring caused by uneven tightening of the retaining cover, when the outer ring end face is pressed as a pilot ring.

Fig. 1.7 shows an example of poor retaining cover tightening for a fixed end bearing resulting in outer ring deformation.

Fig. 1.8 shows deformation of an outer ring raceway surface caused by tightening of a double row cylindrical roller bearing.

The amount of deformation depends on the clearance of the mating parts. It is recommended that the clearance between the retaining cover and housing end face be adjusted to about 0.01 to 0.05 mm before the bolts are completely tightened.

Fig. 1.6 Raceway Surface Deformation Caused by Excessive Tightening

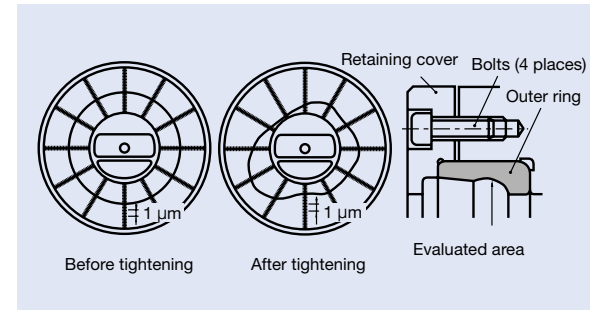

Fig. 1.7 Raceway Surface Deformation Caused by Excessive Tightening

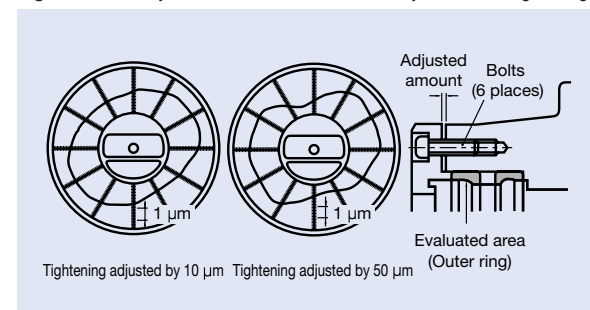

Fig. 1.8 Deformation of the Outer Ring of a Double Row Cylindrical Roller Bearing Caused Excessive Tightening

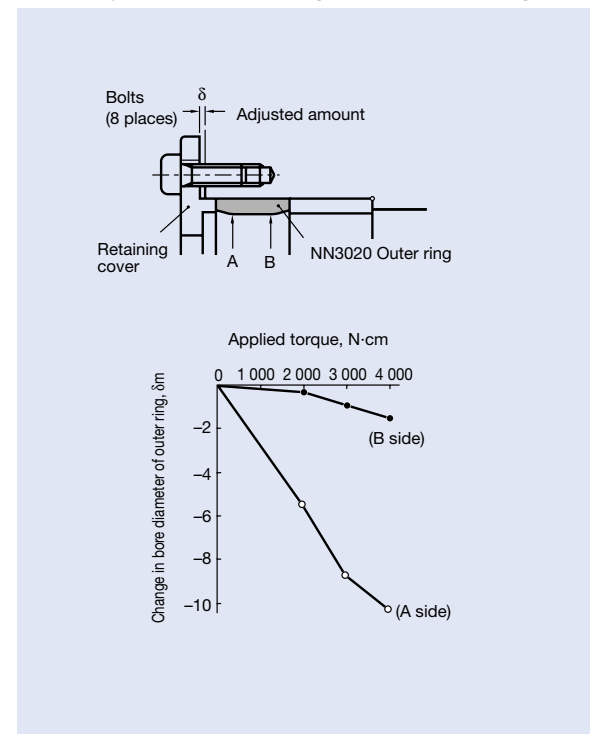

Table 1.1 Bearing Locknut Tightening Torque and Clearance between Retaining Cover and Housing

Nominal bearing bore (mm)	Locknut tightening force (N)	Locknut tightening torque Reference (N·m)	Clearance between retaining cover and housing (mm)
6	1 500	2	0.01 -0.03
8		2	
10		3	
12	3 000	7	
15		8	
17		9	
20	4 900	17	
25		21	
30		25	
35		57	
40	9 800	64	
45		72	
50		80	
55		132	
60		142	
65	14 700	153	
70		166	
75		176	
80		251	
85	19 600	267	
90		281	
95		296	
100		311	
105		327	
110		343	
120		371	
130	403		
140	29 400	649	
150		695	
160		745	
170		796	
180		841	
190		886	
200		932	
220	39 200	-	
240		-	
260		-	
280		-	
280		-	
300		-	

When interference fit of the shaft increases under high speed operations, the amount of tightening torque applied to the locknut must also be increased.

The tightening force of angular contact thrust ball bearing for ball screw support should be 2.5–3.0 times of the preload.

■ Conversion equation of locknut tightening torque

$$T = 0.5F \left\{ d_p \cdot \tan(\rho^* + \beta) + d_w \cdot \mu_w \right\} \quad [\text{N}\cdot\text{mm}]$$

The values of locknut tightening torque in the table are calculated by friction coefficient of 0.15.

- T : Locknut tightening torque [N·mm]
- F : Locknut tightening force [N]
- d_p : Effective diameter of locknut [mm]
- ρ^* : Friction angle of locknut surface
 $\rho^* = \tan^{-1} \mu_s$
- μ_s : Friction coefficient of locknut surface
- d_w : Frictional torque equivalent diameter at locknut surface [mm]
- μ_w : Friction coefficient of locknut surface
- β : Lead angle of nut
 $\beta = \tan^{-1}(\text{pitch}/(3.142 \cdot dp))$

■ Equation of push up force

$$K = \mu \cdot \rho_m \cdot \pi \cdot d \cdot B \quad [\text{N}]$$

$$\rho_m = \frac{E}{2} \frac{\Delta d}{d} \frac{(1-k^2)(1-k_0^2)}{1-k^2 k_0^2}$$

- μ : Friction coefficient at fitting surface [=0.12]
- ρ_m : Surface pressure [MPa]
- d : Shaft diameter [mm]
- B : Bearing width [mm]
- Δd : Effective interference [mm]
- E : Young's modulus of steel [MPa]
- k : Wall thickness ratio ($k = d/D_i$)
- D_i : Raceway diameter of inner ring [mm]
- k_0 : Wall thickness ratio of hollow shaft ($k_0 = d_0/d$)
- d_0 : Bore diameter of hollow shaft [mm]

3.4. Mounting of Cylindrical Roller Bearings

(1) Measuring radial clearance of cylindrical roller bearings

A GN gauge is an instrument for matching the tapered section of a shaft to the tapered bore of a bearing when mounting a cylindrical roller bearing with a tapered bore onto a machine tool spindle. After mounting, the GN gauge is used for precise control of the bearing's radial internal clearance. This instrument is especially effective when a cylindrical roller bearing is used with radial preload.

Fig. 1.9 describes the GN gauge components.

Fig. 1.9 GN Gauge

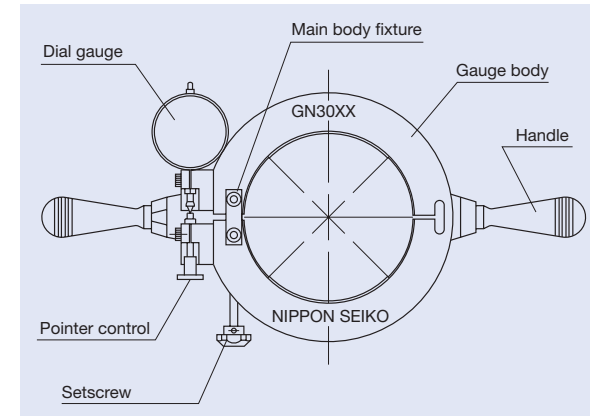

How to use a GN gauge

① Insert outer ring into housing

The recommended fit between outer ring and housing is:

Clearance 2 μm - Interference 2 μm

② Zero setting of cylinder gauge

Confirm that the temperatures are the same for the outer ring (inserted into the housing), the inner ring, and the shaft. Then, measure the bore diameter of the outer ring at about four different locations. Determine the average for the measurements and the cylinder gauge to zero (see Fig. 1.10).

③ Adjust the inscribed diameter of GN gauge

Loosen the bolt of the main body fixture on the GN gauge. Apply the cylinder gauge to the inscribed diameter surface of the GN gauge and adjust the setscrew to the setting of the dial on the cylinder gauge to zero (see step ②).

(Use the GN gauge in an upright position to avoid inaccuracies due to its own weight.)

④ Correction of GN gauge

Using the results from step ③, use the pointer control on the dial gauge to adjust the pointer on the GN gauge to the red mark for gauge correction. Confirm that the short needle is near 2 on the dial.

(Gauge correction corrects for elastic deformation of the roller due to measuring pressure on the gauge. The amount of correction for each gauge is determined upon shipment a gauge.)

Fig. 1.10 Zero Setting of Cylinder Gauge



Fig. 1.11 Adjust the Inscribed Diameter of the GN Gauge



⑤ Mounting of inner ring

Mount the inner ring onto the shaft and tighten the locknut lightly. At this time, the bearings should be cleaned, but not yet coated with grease.

⑥ Setting of GN gauge

Adjust the setscrew on the GN gauge (0.2 mm to 0.3 mm on the dial face) to spread open the dial on the GN gauge. The GN gauge is placed in the center of inner ring and the setscrew is loosened.

⑦ Reading of the scale

Read the scale on the dial gauge of the GN gauge at this time.

Example 1: A half-shift of the dial from zero in a clockwise direction indicates positive clearance.

Example 2: A half-shift of the dial from zero in a counter-clockwise direction indicates negative clearance.

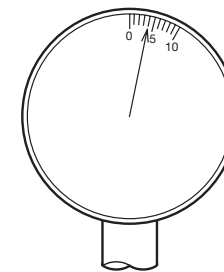

Example 1: Pointing to "4" in a clockwise direction indicates a radial clearance of +0.002 mm

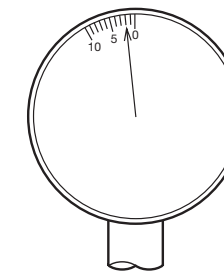

Example 2: Pointing to "2" in a counter-clockwise direction indicates a radial clearance of -0.001 mm

⑧ Adjustment

In addition to procedures given in step ⑥, use the screw to spread the dial of the GN gauge. Remove the gauge from inner ring and tighten the locknut. Repeat steps ⑥ through ⑧ until the scale of the dial gauge reaches the target clearance value.

⑨ Adjustment of spacer

Measure the clearance between the shaft shoulder and the end face on the large diameter side of NN30XXKR by using block gauge. Measure more than three places on circumference to both an average and the finish width of spacer for that average.

Fig. 1.12 Insertion of Inner Ring



Fig. 1.13 Setting of GN Gauge

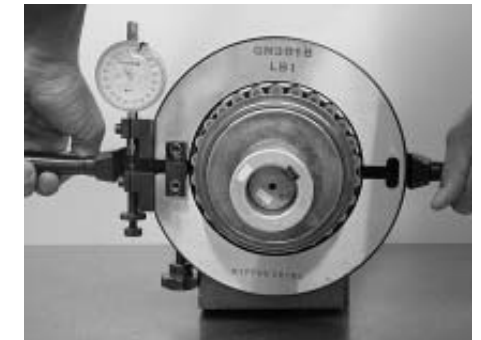

Fig. 1.14 Reading of the Scale



Fig. 1.15 Measurement of Spacer Width



(2) Measuring radial clearance of cylindrical roller bearings (GN gauge is not used)

When the GN gauge is not used, it is necessary to adjust the spacer width by considering the following two items:

- Shrinkage of outer ring raceway diameter due to fitting in housing (Δr_e)
- Expansion of the inner ring raceway diameter due to fitting, which includes a hollow shaft ratio (Δr_i)

■ Calculation of Δr

The finish dimension (L_a) of the spacer, which is used for setting the post-mounting radial clearance of Δr , can be calculated as follows:

$$L_a = L - K (\Delta r_m - \Delta r + \Delta r_e)$$

Table 1.2 Hollow Shaft Ratio and Coefficient K

Hollow shaft Ratio k_0	Coefficient K
45–55%	14
55–65%	15
65–75%	16

■ Calculation of Δr_e

$$\Delta r_e = (D_h - D) \times h$$

when $\Delta r_e \geq 0$ assume $\Delta r_e = 0$

L_a : Finish dimension of spacer for setting post mounting radial clearance
 L : Width of block gauge (Measured result from step ⑤ on Page 205.)
 Δr_m : Movement of the outer ring in radial direction (Measured result from step ④ on Page 205.)
 Δr : Radial clearance after mounting
 Δr_e : Shrinkage of outer ring raceway diameter due to fitting
 K : Coefficient (Converted value which includes shrinkage of a hollow shaft with a 1/12 tapered hole)
 k_0 : $A/B \times 100$
 A: Shaft bore diameter B: Shaft outer diameter

D_h : Housing bore diameter
 D : Outer diameter of outer ring (Refer to bearing inspection sheet)
 h : Shrinkage rate of the outer ring raceway diameter
 (0.62 for NN30 and N10 series)
 (0.7 for NN39 and NN49 series)

Measuring of radial clearance of Δr_m

- ① Mount the inner ring onto the tapered section of the shaft. (At this point, degrease the tapered section of the shaft and internal surface of the inner ring with organic solvent.)
- ② Place the outer ring on the circumscribing part of the rollers and apply the dial gauge to outer diameter of the outer ring.
- ③ Tighten the spacer and the locknut now to expand the inner ring (see Fig. 1.16).
- ④ Push the outer ring in up and down and measure the radial movement of the outer ring with dial gauge (*). Repeat steps ③ and ④ until play of the outer ring (Δr_m) becomes about 0.005 mm (*) (Fig. 1.17).
- ⑤ When Δr_m is set at about 0.005 mm, measure the distance from shaft shoulder to the inner ring end face (Dimension L) with block gauge and the thickness gauge (*) (see Fig. 1.18).

Remarks

- (*)1 If the measurement takes too long, the temperature of the outer ring may have risen to body temperature resulting in an erroneous measurement. Wearing gloves is recommended to for making a quick measurement.
- (*)2 If there is an excessive amount of play, the outer ring may have deformed into an ellipse when pressed by hand. This would result in an erroneous measurement. Therefore, 0.005 mm of play is acceptable. (0.005 mm is the target value, but 0.001 mm to 0.002 mm is also acceptable.)
- (*)3 For the measurement of dimension L , the value obtained is produced by inserting the block gauge in the left half of the zone shown in Fig. 1.18 (This is due to tilting that occurs between the shaft shoulder and inner ring end face.)

Fig. 1.16 Insertion of Outer Ring

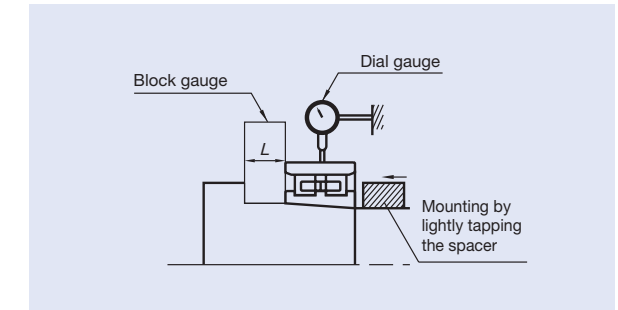

Fig. 1.17 Measuring Outer Ring Movement

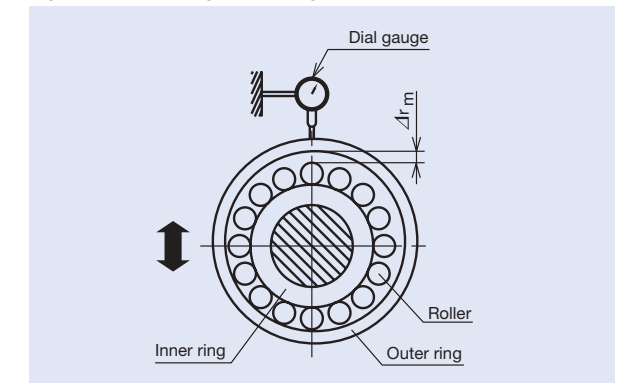
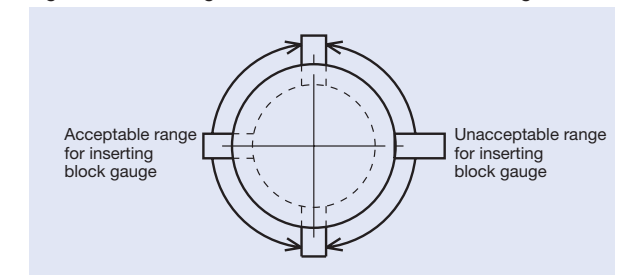

Fig. 1.18 Measuring Width Dimension with Block Gauge



(Example of calculation)

Setting radial clearance to $\Delta r = -0.002$ mm for NN3020MBKR after mounting.

Shrinkage of outer ring raceway diameter due to fitting: $\Delta r_e = -0.004$ (Interference) (When $\Delta r_e \geq 0$ assume $\Delta r_e = 0$)

Movement of outer ring (Measured value in step ④): $\Delta r_m = 0.007$ mm

Block gauge width (Measured value in step ⑤): $L = 20.55$ mm

Finish spacer width dimension:

$$\begin{aligned} L_a &= 20.55 - 15 \times (0.007 - (-0.002) - 0.004) \\ &= 20.55 - 0.075 \\ &= 20.475 \end{aligned}$$

Note the code!

3.5. Grease Packing

Procedure for packing grease after cleaning bearings

A rapid rise in temperature may occur during initial running-in due to improper packing of grease. This can result in a long running-in period, or lead to seizure and bearing failure. Following proper procedures for packing grease and using the correct amount of grease deserves careful attention. Recommended procedures are as follows:

1. Pre-inspection

Check to ensure there is no foreign matter in the bearing interior. Bearings for high speed spindle shafts should be cleaned, degreased, and packed with grease. For other applications, remove any anti-corrosion agent adhering to interior surfaces of the bearings.

2. Grease dispensers

Use a grease dispenser, such as a plastic syringe for precision grease dispensing. If possible, use a dispenser that comes with a gauge for packing accurate amounts of grease.

3. Amount of grease

Recommended amounts of grease packing for precision bearings:

Angular contact ball bearings for high speed machine tool spindles: $15\% \pm 2\%$ of internal space

Cylindrical roller bearings for high speed machine tool spindle: $10\% \pm 2\%$ of internal space

Ball bearings for motors: 20% to 30% of internal space

Recommendation of grease amount for various bearing types and numbers is shown on Page 175.

Packing method for ball bearings

- (1) Pack grease evenly between the balls. If an outer ring guided cage is used, such as a phenolic resin cage, apply a light coating of grease on the guided surface.
- (2) Rotate the bearing by hand to spread grease evenly on the surfaces of the raceway, ball, and cage.

Packing method for cylindrical roller bearings

- (1) Coat about 80% of the grease amount evenly on roller rolling surface. Avoid putting too much grease on the cage bore. Grease on the cage bore is difficult to disperse during the running-in period, which can result in a rapid rise in temperature or a long running-in period.
- (2) Coat roller surfaces with a thin film of grease, including the roller end faces, roller cage contact points, and along the face edges of each cage pocket.
- (3) Using the remaining 20% of grease, apply a thin film of grease to the raceway surface of the outer ring.

Fig. 1.19 Grease Packed Angular Contact Ball Bearing



Fig. 1.20 Grease Packed Cylindrical Roller Bearing



4. Inspection after Mounting

4.1. Runout accuracy

Accurate mounting and related parts are indispensable to ensure precision and accuracy of the machine tool spindle.

- 1: Assembled bearing outer ring face runout with raceway for angular contact ball bearings.
Adjust to 0.002 mm or less by tapping on the outer ring end face.
- 2: Variation of bearing outside surface generatrix inclination with outer ring reference face for angular contact ball bearings.
Adjust to 0.005 mm or less tilting the locknut (see Fig. 1.21).

- 3: Concentricity of rear side housing 0.010 mm or less.

If these accuracies cannot be met, disassemble the bearings and check the accuracy of parts again.

Fig. 1.21 Tilting the Shaft Locknut

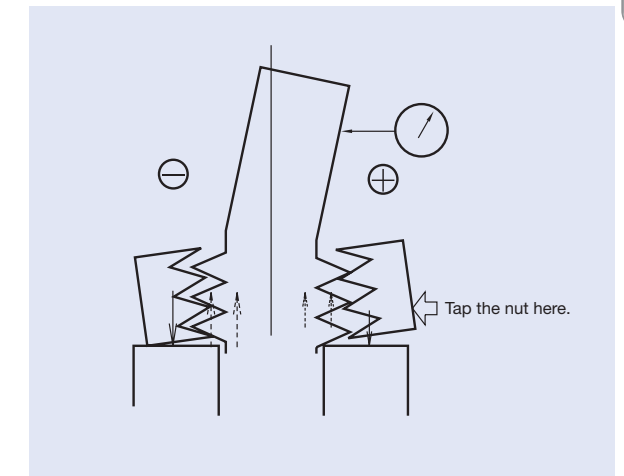
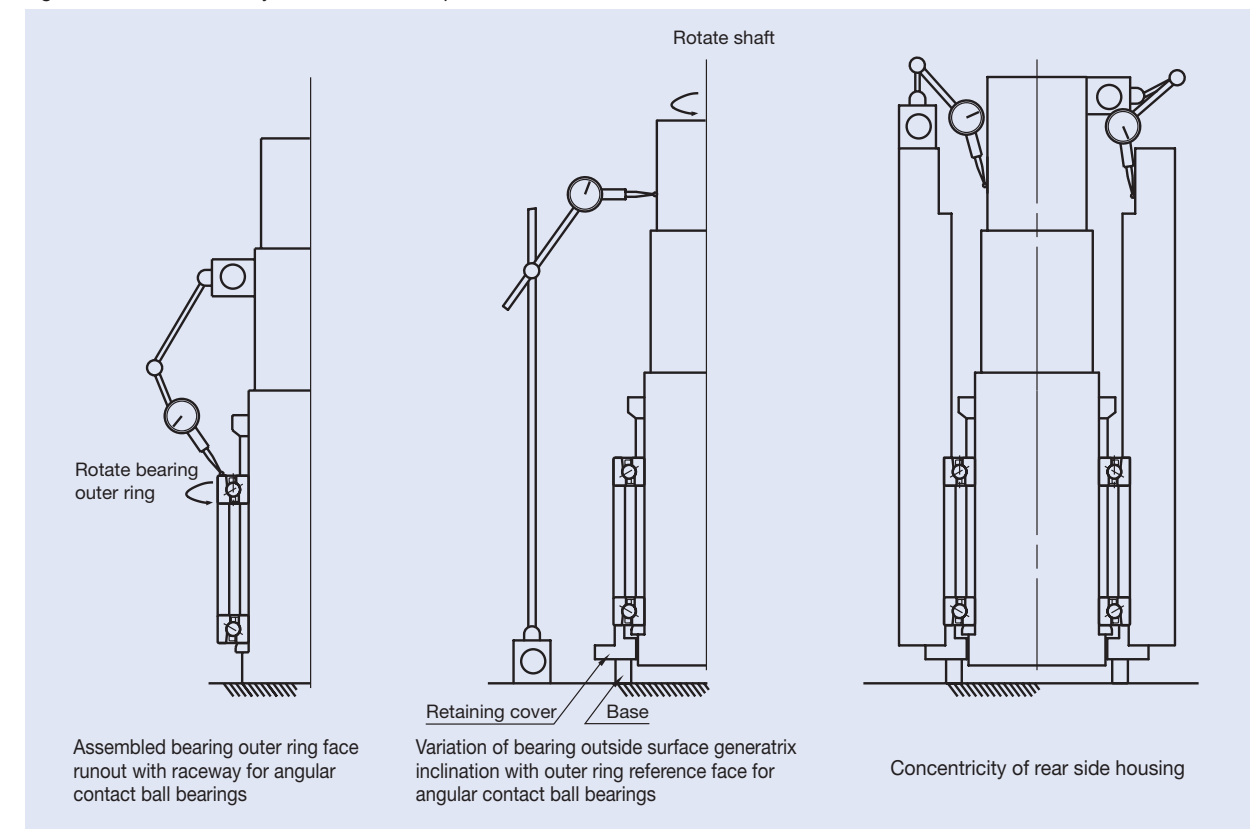

Fig. 1.22 Runout Accuracy of Machine Tool Spindle



4.2. Control of Preload after Mounting of Bearings

If the preload of rolling bearing is set larger, the rigidity of bearing is increased, but heat generation is also increased, and in extreme cases, seizure may occur. Therefore, it is necessary to control optimum preload carefully in response to operating condition. Measuring method of preload for angular contact ball bearing is introduced below. For the preload of cylindrical roller bearing, it is recommended to control by using a GN gauge in mounting process (see Page 202).

Measuring of preload for angular contact ball bearings

There are three methods for checking preload of bearings after mounting onto the main shaft: starting torque method, thrust static rigidity method, and natural frequency method.

Features of these methods are summarized in Table 1.3.

Table 1.3

	Starting torque method	Thrust static rigidity method	Natural frequency method
Advantage	Used for heavy preload, If starting torque is high, measurement error is small.	Used for light preload	Measurement accuracy is high. Good repeatability.
Disadvantage	Not good for light preload. If starting torque is small, variation of measurement is large.	Not good for heavy preload. Loading equipment is too large scale. Affected easily by deformation of contact part other than bearing.	Influence of spindle fixing condition should not be ignored.

(1) Starting torque method

[Characteristic]

High speed main shaft spindle bearings are often used with light preload so that starting torque is low and measurement error is large.

[Method]

Starting torque is obtained mainly by measuring tangential force (see Fig. 1.23).

Preload is obtained from the relationship between measured starting torque and preload (see Fig. 1.24).

When oil film formation in rolling contact area is unstable during measurement, sticking occurs (Rotation does not start even under tangential force and rotation starts suddenly when tangential force is increased gradually). The torque at such occasion tends to be higher than predicted calculated torque so that the excessive measurement result needs to be excluded.

Fig. 1.23 Starting Torque Method

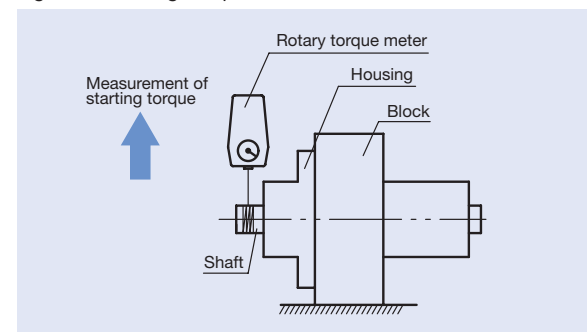
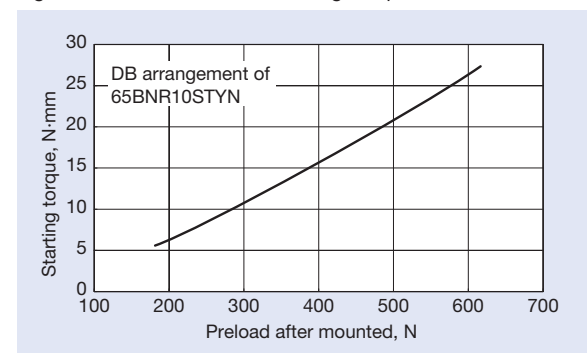

Fig. 1.24 Relation between Starting Torque and Preload



(2) Thrust static rigidity method

[Characteristic]

When axial rigidity of the bearing is high, axial force necessary for measurement becomes very high and loading equipment is necessary (Example: If axial rigidity is 200N/μm, 2 000N load is needed to generate 10 μm displacement). When measurement load is large, besides elastic deformation of bearing interior, effect of surface deformation and elastic deformation of other related parts are added. Measured rigidity tends to be lower than theoretical value and error often occurs.

[Method]

Thrust load is applied to shaft and its axial displacement is measured for obtaining preload (see Figs. 1.25 and 1.26).

(3) Natural frequency method

[Characteristic]

Measuring sensitivity is the highest and repeatability is good, but tend to be affected by spindle fixing condition.

[Method]

Shaft is vibrated in an axial direction and resonance frequency of shaft is measured at the same time. Preload can be obtained by the resonance frequency (see Figs. 1.27 and 1.28).

Fig. 1.25 Thrust Static Rigidity Method

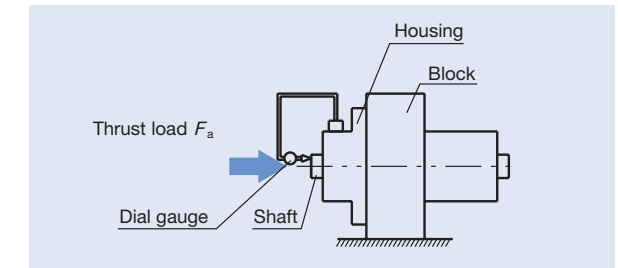

Fig. 1.26 Relation between Axial Displacement and Preload

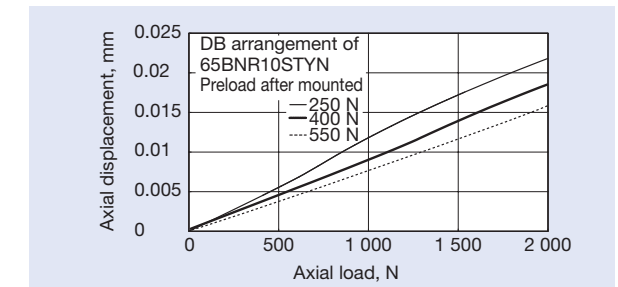

Fig. 1.27 Natural Frequency Method

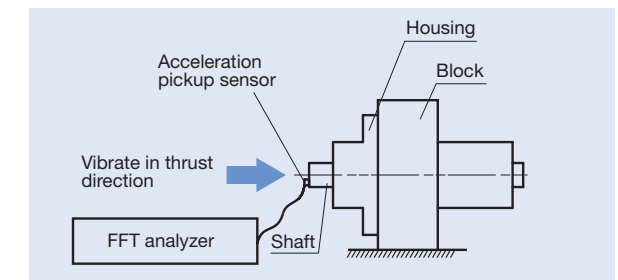
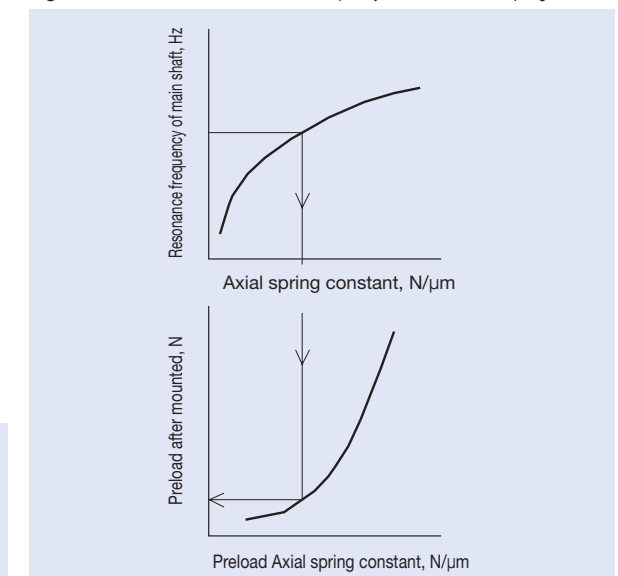

Fig. 1.28 Relation between Resonance Frequency of Main Shaft and Spring Constant



Measurement of resonance frequency (F_z) for main shaft in axial direction

$$F_z = \frac{1}{2\pi} \sqrt{\frac{K_a}{m}} \times 1000$$

Convert

Axial spring constant of main shaft

Convert

Preload after mounted

K_a : Axial spring constant of bearing (N/μm)
 F_z : Resonance frequency (Hz)
 m : Mass of rotating body (kg)

Operating Inspection

After mounting has been completed, a test run should be conducted to determine if the bearing has been mounted correctly. Small equipment may be manually operated to assure that they rotate smoothly. Items to be checked include sticking due to foreign matter, visible flaws, uneven torque caused by improper mounting, or an improper mounting surface. Other items include excessive torque caused by an inadequate clearance, mounting errors, or seal friction.

If there are no abnormalities, then a powered test run can be started. For high-speed equipment, perform running-in procedures before a powered test run (Pages 212-213). A powered test run should be started slowly without load. Make close observations to determine whether or not abnormalities exist. If everything seems satisfactory, then gradually increase the speed, load, etc., until normal operating conditions are reached.

During a test run operation, check for abnormal noise, excessive rise of bearing temperature, leakage and contamination of lubricants, etc. If any abnormality is found, stop the test run immediately and inspect the machinery. If necessary, the bearing should be dismantled for examination as well. Although the temperature of the outside surface of the housing can generally help determine bearing temperature, it is

better to directly measure the temperature of the outer ring using oil holes for access. The bearing temperature should rise gradually to a steady level within one or two hours after operation starts. If the bearing experiences trouble, or if an error was made in mounting, the bearing temperature may increase rapidly and become abnormally high. The cause of this abnormal temperature may be an excessive amount of lubricant, insufficient bearing clearance, incorrect mounting, or excessive friction of the seals. In the case of high speed operations, an incorrect selection of bearing type or lubricating method may also cause an abnormal temperature rise. Bearing noise can be checked with an acoustic or other instruments. Abnormal conditions are indicated by a loud metallic sound, or other irregular noise. Possible causes include incorrect lubrication, poor alignment of the shaft and housing, or the entry of foreign matter into the bearing. Possible causes and countermeasures for irregularities are listed in Table 2.1.

Table 2.1 Cause and Countermeasures for Operating Irregularities

Irregularities		Possible cause	Countermeasures
Noise	Loud metallic sound (!)	Abnormal load	Improve the fit, internal clearance, preload position of housing shoulder, etc.
		Incorrect mounting	Improve the machining accuracy and alignment of shaft and housing, accuracy of mounting method.
		Insufficient or improper lubricant	Replenish the lubricant or select another lubricant.
		Contact of rotating parts	Modify the labyrinth seal, etc.
	Loud regular sound	Dents generated by foreign matter, corrosion, flaws, or scratches on raceways	Replace or clean the bearing, improve the seals, and use clean lubricant.
		Brinelling	Replace the bearing, and use care when handling bearings.
		Flaking on raceway	Replace the bearing.
	Irregular sound	Excessive clearance	Improve the fit, clearance, and preload.
		Penetration of foreign particles	Replace or clean the bearing, improve the seals, and use clean lubricant.
Flaws or flaking on balls		Replace the bearing.	
Abnormal temperature rise	Excessive amount of lubricant	Reduce amount of lubricant, or select stiffer grease.	
	Insufficient or improper lubricant	Replenish lubricant or select a better one.	
	Abnormal load	Improve the fit, internal clearance, preload, or position of housing shoulder.	
	Incorrect mounting	Improve the machining accuracy and alignment of the shaft and housing, accuracy of mounting, or mounting method.	
	Creep on fitted surface, excessive seal friction	Correct the seals, replace the bearing, or correct the fitting or mounting.	
Vibration (Radial runout of shaft)	Brinelling	Replace the bearing and use care when handling bearing.	
	Flaking	Replace the bearing.	
	Incorrect mounting	Correct the squareness between the shaft and housing shoulder or side of spacer.	
	Penetration of foreign particles	Replace or clean the bearing, improve the seals.	
Leakage or discoloration of lubricant	Too much lubricant. Penetration by foreign matter or abrasion chips	Reduce the amount of lubricant, select a stiffer grease. Replace the bearing or lubricant. Clean the housing and adjacent parts.	

Note (!) Squeaking may arise from grease lubricated ball bearings or cylindrical roller bearings (medium to large sized). This is especially true during winter when temperatures are low. In general, even though squeaking may occur, the bearing temperature will not rise, leaving fatigue or grease life unaffected. Consequently, such a bearing can continue to be used. If you concerns regarding squeaking noise, please contact NSK.

Preparations

The following running-in procedures are necessary after properly mounting bearings.

■ Balance of Shaft and Assembly

Any unbalance of rotating components will cause repeated stress or excessive vibrations due to centrifugal force. This is especially true for spindles, which are operated at a $d_m n$ value of 1 000 000 or higher. Therefore, it is imperative that both the shaft assembly are well balanced.

■ Spindle Assembly

Spindle assemblies with a V-belt drive should have misalignment of the spindle pulley center and motor pulley center corrected to a target of 0.1 mm or less. Coupling joints should have misalignment of the spindle shaft center and motor shaft center corrected to a target of 0.01 mm or less.

Initial Running in Methods

If operating speed is suddenly increased after the bearings are mounted, the operating temperature will rise abruptly and bearing failure may occur. Grease lubricated bearings, especially, require that you follow proper running-in procedures. Increase operating speed gradually to completely orient the initially filled grease on each contact surface raceway. Running in should be conducted under ambient temperature conditions (15°C to 25°C) while monitoring bearing temperature.

Maximum operating temperature of the spindle housing exterior should be targeted at about 50°C. Do not to exceed 55°C. If a rapid temperature increase occurs, temporarily stop the running-in process or decelerate to lower the temperature. Some spindle assemblies incorporate both cylindrical roller bearings and angular contact ball bearings. Since cylindrical roller bearings tend to experience a more rapid temperature increase in comparison with ball bearings, timing of speed increases must be set to correspond with the roller bearings.

[Caution]

Spindle assemblies operating under oil mist and oil-air lubricating conditions risk a sudden temperature rise at initial operation, or after the spindle assembly has not been operated for a long time. Excess oil that has collected in the oil lines of the lubrication system may suddenly flood the bearing interior, causing a temperature spike. Performing running-in procedures for bearings with these lubricating systems require much less time than grease-based systems, and are highly recommended.

(1) Continuous running-in procedure

[Feature]

Continuous running-in works by gradually increasing operating speed from the low speed zone. Although somewhat time consuming, this procedure helps machine operators to detect potential problems related to the main shaft, thus avoiding costly damage to the bearings.

[Method]

Maximum operating speed of the application is achieved by repeating several steps in a cycle.

Step 1. Begin at a reasonably low operating speed.

Step 2. Monitor for temperature rise.

Step 3. Stable temperature is reached.

Step 4. Continue incremental increases of operating speed.

Continue repeating the above cycle until an equilibrium temperature is reached at the maximum operating speed and divide it into ten stages to determine the target speed for each stage. Then, repeat the above cycle for one or two hours until the target speed is reached for that stage. Move up to the next stage and repeat the above cycle until you reach the next target speed.

Fig. 3.1 Temperature Change of Constant Speed Running-in Operation

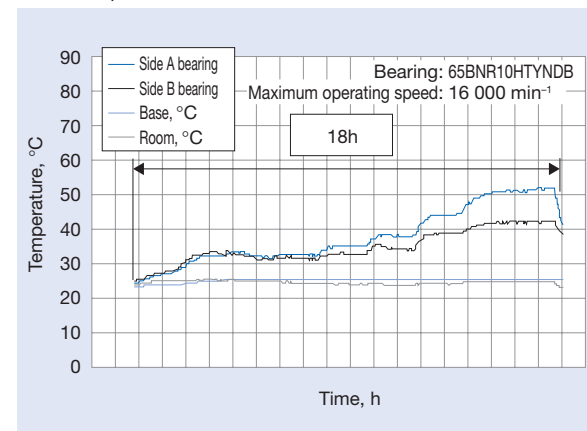
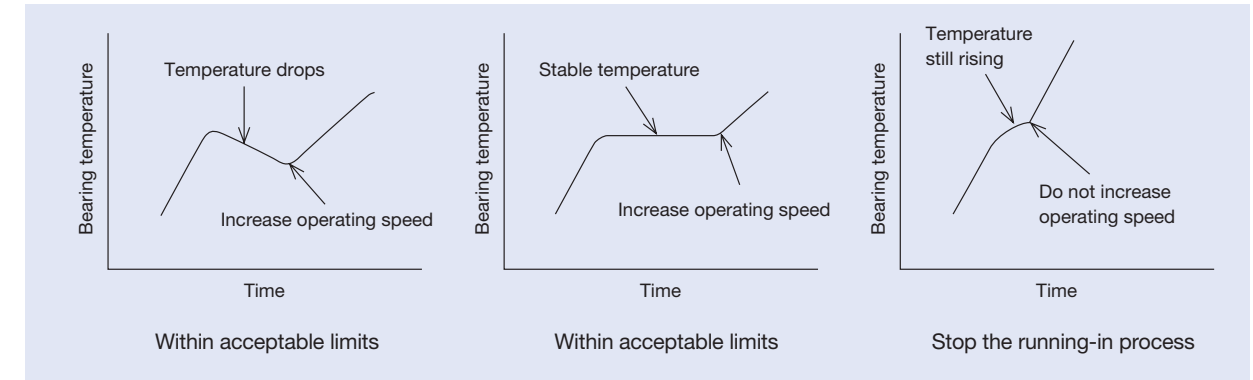

Fig. 3.2 Increase of Operating Speed Continuous Running in



Increase operating speed when temperature rise characteristics are within limits.

(2) Intermittent Running-in procedure

[Feature]

Intermittent Running in works by stopping operation and stabilizing temperatures before there is a rapid temperature rise, which is caused by a sudden supply of grease to the bearing interior during initial operation. This procedure allows us to shorten the amount of time required for running in. Procedures for intermittent running in vary from machine to machine and bearing arrangements. Be sure to confirm the bearing arrangement for each spindle application.

[Method]

First, take the maximum operating speed and divide it into eight or ten stages to determine the maximum target speed for each stage. Each stage is divided into 10 cycles that are approximately one minute long.

During each cycle, rapidly accelerate the spindle assembly to the target speed for the current stage decelerate back to zero. Repeat this cycle about 10 times. Move up to the next stage and repeat the above cycle 10 times for the target speed of that stage.

Fig. 3.3 shows temperature rise data for a bearing with a maximum operating speed of 16 000 min⁻¹. The maximum speed was divided into 8 stages with 10 cycles each of rapid acceleration and deceleration. Fig. 3.4 shows an example of 1 cycle. And it is desirable to make it rotate slowly by about 500 min⁻¹ for 15 minutes, and to familiarize grease and before operating start. As for after an operation end, it is desirable to perform fixed operation about 1 hour at maximum speed.

Fig. 3.3 Temperature Change of Intermittent Running-in Operation

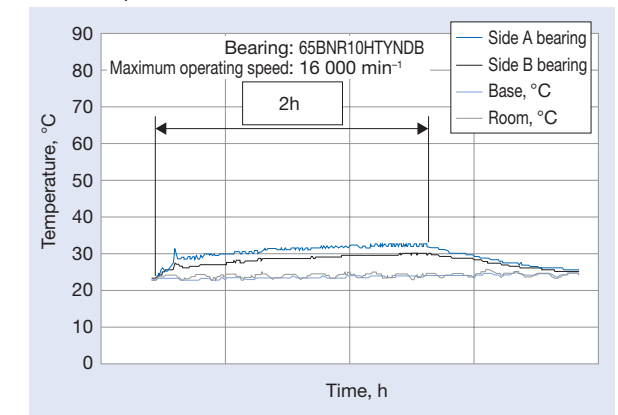
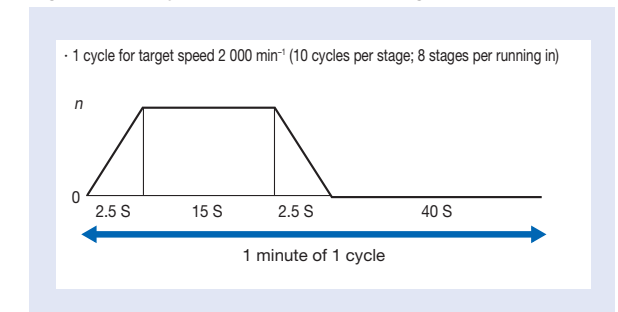

Fig. 3.4 One Cycle for Intermittent Running-in Procedure





Bearing Failure Diagnosis

- 1. Bearing Failure and MeasuresP216-219
- 2. Diagnosis with Sound and VibrationP220-225

Bearing Failure and Measures
Diagnosis with Sound and Vibration

Bearing Failure Diagnosis

Maintenance, Inspection and Correcting Irregularities

In order to maintain the original performance of a bearing for as long as possible, proper maintenance and inspection should be performed. If proper procedures are used, many bearing problems can be avoided and the reliability, productivity, and operating costs of the equipment containing the bearings are all improved. It is suggested that periodic maintenance be done following the procedure specified. This periodic maintenance encompasses the supervision of operating conditions, the supply or replacement of lubricants, and regular periodic inspection.

Items that should be regularly checked during operation include bearing noise, vibration, temperature, and lubrication. If an irregularity is found during operation, the cause should be determined and the proper corrective actions should be taken after referring to Table 2.1.







If necessary, the bearing should be dismantled and examined in detail.



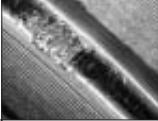









Bearing Failure and Measures

In general, if rolling bearings are used correctly they will survive to their predicted fatigue life.

However, they often fail prematurely due to avoidable mistakes. In contrast to fatigue life, this premature failure is caused by improper mounting, handling or lubrication, entry of foreign matter, or abnormal heat generation. For instance, the causes of rib scoring, as one example, are the use of improper lubricant, faulty lubricant system, entry of foreign matter, bearing mounting error, excessive deflection of the shaft, or any combination of these. Thus, it is difficult to determine the real cause of some premature failures. If all the conditions at that time of failure and previous to the time of failure are known, including the application, the operating conditions, and environment; then by studying the nature of the failure and its probable causes, the possibility of similar future failures can be reduced. The most frequent types of bearing failure, along with their causes and corrective actions, are listed in Table 1.1.

Table 1.1 Causes and Measures for Bearing Failures

Type of Failure	Irregularities	Photo	Probable Causes	Measures
Flaking	Flaking on one side of the raceway of radial bearing.		Abnormal axial load (sliding failure of free-side bearing).	When mounting the outer ring of free-side bearings, it should be fitted loosely, to allow axial expansion of the shaft.
	Flaking pattern inclined relative to the raceway in radial ball bearings Flaking near the edge of the raceway and rolling surface in roller bearing.		Improper mounting, bending of shaft, inadequate centering, inadequate tolerances for shaft and housing.	Use care in mounting and centering, select a bearing with a large clearance, and correct the squareness of shaft and housing shoulder.
	Flaking of raceway with same spacing as rolling element.		Large shock load during mounting, rusting while bearing is out of operation for prolonged period, mounting flaws of cylindrical roller bearings.	Use care in mounting and apply a rust preventative when machine operation is suspended for a long time.
	Premature flaking of raceway and rolling element.		Insufficient clearance, excessive load, improper lubrication, rust, etc.	Select proper fit, bearing clearance, and lubricant.
	Premature flaking of combined bearings.		Excessive preload.	Adjust the preload.
Scoring	Scoring or smearing between raceway and rolling surface.		Inadequate initial lubrication, excessively hard grease, high acceleration when starting operation.	Use a softer grease and avoid rapid acceleration.

Type of Failure	Irregularities	Photo	Probable Causes	Measures
Scoring	Scoring or smearing between the end face of the rollers and guide rib.		Inadequate lubrication, incorrect mounting and large axial load.	Select proper lubricant and modify the mounting.
Cracks	Crack in outer or inner ring.		Excessive shock load, excessive interference in fitting, poor shaft cylindricity, improper sleeve taper, large fillet radius, development of thermal cracks and increased flaking.	Examine the loading conditions, modify the fit of bearing and sleeve, improve accuracy in machining shaft and sleeve, collect fillet radius (the fillet radius must be smaller than the bearing chamber).
	Crack in rolling element or broken rib.		Increased flaking, shock applied to rib during mounting or dropped during handling.	Use care in mounting and handling a bearing.
	Fracture of cage.		Abnormal loading on the cage due to incorrect mounting. Improper lubrication	Correct mounting and examine the lubrication method and lubricant.
Indentations	Indentation on raceway with the same spacing as rolling element (Brinelling).		Shock load during mounting or excessive load when not rotating.	Use care in handling the bearing.
	Indentations on raceway and rolling elements.		Entry of foreign matter such as metallic particle and grit.	Clean the housing, improve the seals and use clean lubricant.
Abnormal wear	False brinelling (phenomenon similar to brinelling).		Vibration of the bearing without rotation when out of operation, such as during transport, or rocking motion of vibration.	Secure the shaft and housing, use oil as a lubricant and reduce vibration by applying preload.
	Fretting, Localized wear with reddish-brown wear dust at fitting surface.		Sliding wear at a minute gap in the fitting surface.	Increase interference and apply oil.
	Wearing on raceway, rolling elements, rib and cage.		Entry of foreign matter, incorrect lubrication and rust.	Improve sealing capabilities, clean the housing and use a clean lubricant.
	Creep, scoring wear at fitting surface.		Insufficient interference, insufficiently secured sleeve.	Modify the fitting and tighten the sleeve properly.
Seizure	Discoloration and melting of raceway, rolling elements and ribs.		Insufficient clearance, incorrect lubrication, or improper mounting.	Examine the fitting and internal clearance of a bearing, supply an adequate amount of proper lubricant and examine the mounting method and quality of related parts.
Corrosion and Rust	Corrosion and rust at bearing interior or fitting surface.		Condensation of water from the air, or fretting, entry of corrosive substance (especially varnish gas).	Store carefully when in a moist or hot climate, take rust prevention measures before removing from operations for a long time, and select proper varnish and grease.

Running Traces and Applied Loads

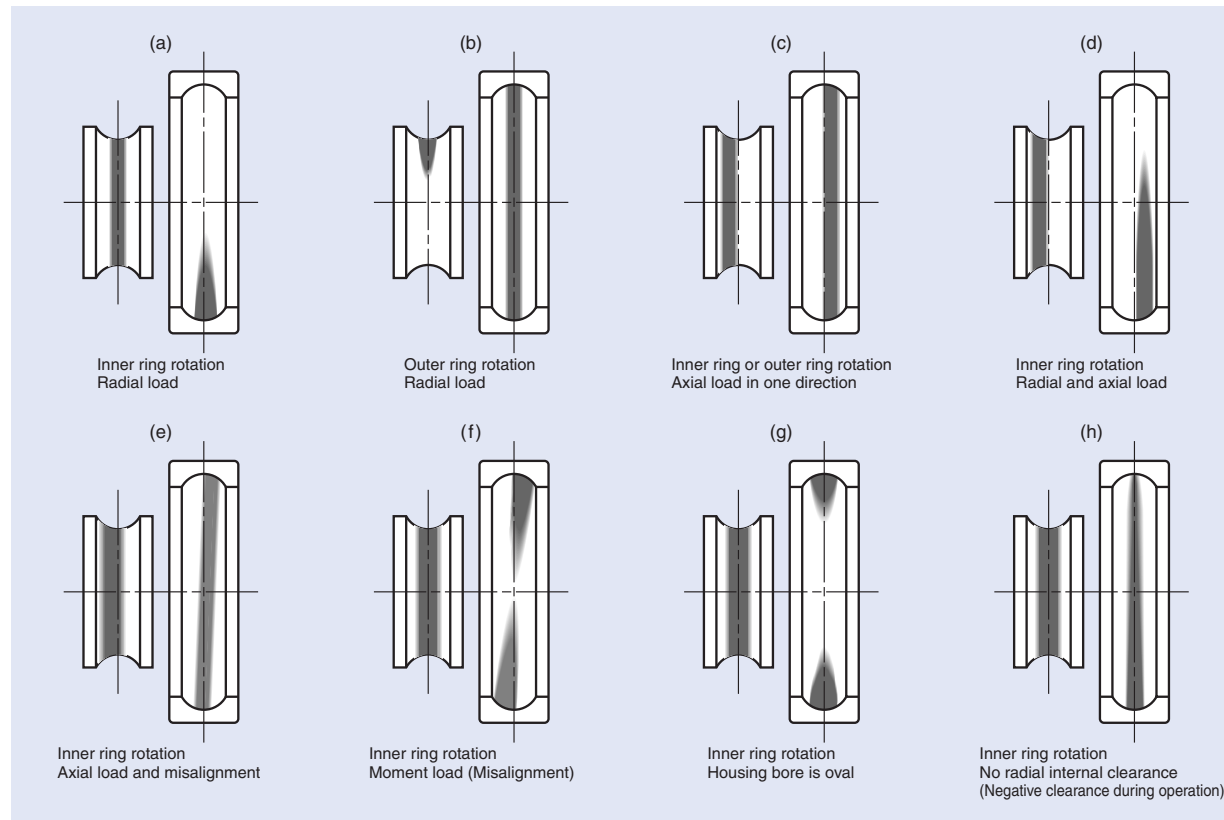

Fig. 1.1 Typical Running Traces of Deep Groove Ball Bearings

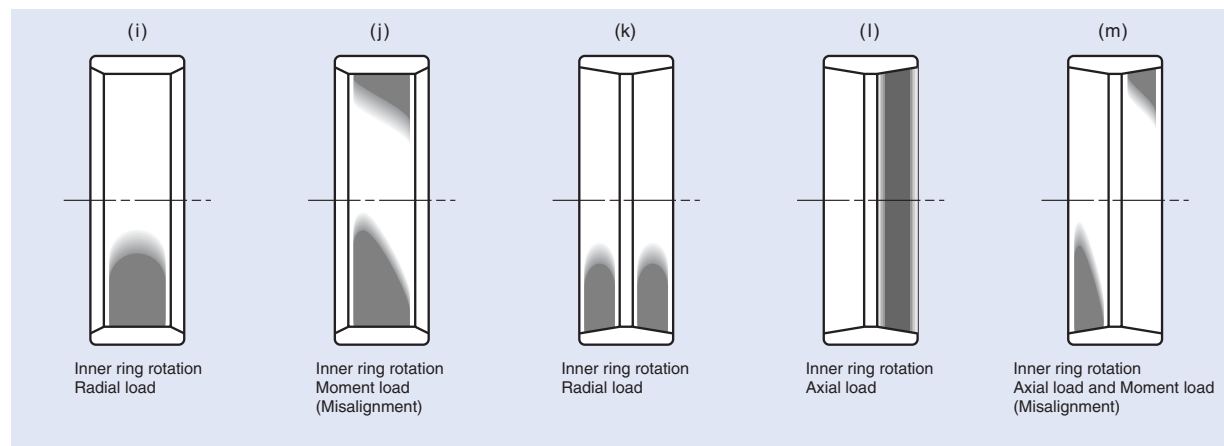

Fig. 1.2 Typical Running Traces of Roller Bearings

Table 1.2 Appendix Bearing Diagnostic Chart

Damage name	Location (Phenomenon)	Typical Cause										Remarks						
		Handling		Bearing surrounding		Lowbrow-cation		Load		Speed								
		Stock, Shipping	Mounting	Shaft, Housing	Sealing device, water, debris	Temperature	Lubricant	Lubrication method	Excessive load	Moment load	Too small load		High speed, high acceleration	Oscillating, vibration, stationary	Bearing selection			
1. Flaking	Raceway, Rolling surface		○	○	○		○	○	○	○								
2. Peeling	Raceway, Rolling contact surface				○		○	○				○	○					
	Bearings outer diameter surfaces			○*	○		○	○										*Mating rolling part
3. Scoring	Roller end surface, Rib surface		○	○	○		○	○	○	○			○					
	Cage guide surface, Pocket surface		○		○		○	○										
4. Smearing	Raceway, Rolling surface				○		○	○				○	○					
5. Fracture	Raceway collar, Rollers	○	○	○					○	○								
6. Cracks	Raceway rings, Rolling elements		○	○		○			○	○								
	Rib surface, Roller end face, Cage guide surface (Thermal crack)			○				○	○	○								
7. Cage damage	(Deformation), (Fracture)		○	○					○	○								
	(Wear)		○		○		○	○	○	○			○					
8. Denting	Raceway, Rolling surface, (Innumerable small dents)				○			○										
	Raceway (Debris on the rolling element pitch)	○	○						○								○	
9. Pitting	Raceway, Rolling surface				○		○	○										
10. Wear	Raceway, Rolling surface, Rib surface, Roller end face		○		○		○	○										
11. Fretting	Raceway, Rolling surface	○	○	○				○	○	○			○	○				
	Bearing outside and bore, side surface (Contact with housing and shaft)		○	○						○								
12. False brinelling	Raceway, Rolling surface	○						○	○								○	
13. Creep	Raceway, Rolling surface		○	○		○		○*	○*	○			○					*Loose fit
14. Seizure	Fitting surface		○	○	○			○	○	○	○	○	○				○	
15. Electrical corrosion	Raceway, Rolling surface		○*	○*														*Electricity passing through the rolling element
16. Rust and corrosion	Raceway ring, Rolling element, Cage	○	○		○	○	○	○										
17. Mounting flaws	Raceway, Rolling surface		○	○														
18. Discoloration	Raceway ring, Rolling element, Cage					○	○	○										

Remark: This table is not comprehensive. It lists only the more commonly occurring damages, causes, and locations.

Classification of sounds and vibrations

Sound and vibration accompany the rotation of rolling bearings. The tone and amplitude of such sound and vibration vary depending on the type of bearing, mounting conditions, operational conditions, etc. The sound and vibration of a rolling bearing can be classified under the following four chief categories and each category can be further classified into several sub-categories, as described in Table 2.1 below. Boundaries between groups are, however, not definite. Even if some types of sounds or vibrations are inherent in the bearings, the volume might be related to the manufacturing process, while some types of sounds or vibrations, even if they arise due to manufacturing,

cannot be eliminated even in normal conditions.

By recording sounds and vibrations of a rotating machine and analyzing them, it is possible to infer the cause. As can be seen from figures on the next page, a mechanically normal bearing shows a stable waveform. However, a bearing with a scratch, for example, shows a waveform with wide swings indicating large-amplitude sounds at regular intervals. NSK produces Bearing Monitor NB-4, a vibration measuring monitor that can diagnose irregularities in a rotating machine, and the causes of the irregularities can be inferred using the NB-4 and recording equipment, such as a personal computer.



Sound waveform of a normal bearing

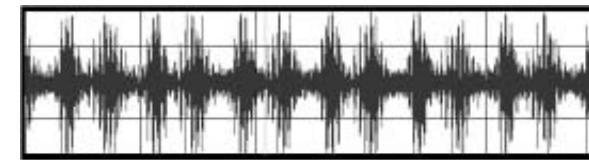

Sound waveform of a scratched bearing



Vibration Measuring Equipment, Bearing Monitor NB-4 (See Page 128)

Table 2.1 Classification of sounds and vibrations in a rolling bearing

	sound	Vibration	Features	
Structural	Race noise	Free vibration of raceway ring	Continuous noise, basic unavoidable noise which all bearings generate	
	Click noise	Free vibration of raceway ring, free vibration of cage	Regular noise at a certain interval, large bearings and horizontal shaft, radial load and low rpm	
	Squeal noise	Free vibration of raceway ring	Intermittent or continuous, mostly large cylindrical roller bearings, radial load, grease lubrication, at particular speed	
	Cage noise	“CK” noise	Free vibration of cage	Regular noise at a certain interval, all bearing types generate it
		“CG” noise	Vibration of cage	Intermittent or continuous, lubrication with particular grease
		Tapping noise	Free vibration of cage	Certain interval, but a little irregular under radial load and during initial stage
	—	Rolling element passage vibration	Continuous, all bearing types under radial load	
Manufacturing	Waviness noise	Inner ring	Continuous noise	
		Outer ring	Continuous noise	
		Rolling element	Continuous with rollers, occasional with balls	
Handling	Flaw noise	Inner ring	Regular noise at a certain interval	
		Outer ring		
		Rolling element		
Contamination noise	Vibration due to contamination	Irregular		
Others	Seal noise	Free vibration of a seal	Contact seal	
	Lubricant noise	—	Irregular	
	—	Runout	f_r	Continuous
			f_c	Continuous
$f_r - 2f_c$			Continuous	

n : Positive integer (1, 2, 3...)
 Z : Number of rolling elements
 f_{RIN} : Ring natural frequency in radial bending mode, Hz
 f_{MI} : Natural frequency in the mode of angular vibration in inertia of outer ring-spring system, Hz
 f_i : Rotation frequency of inner ring, Hz

Generated frequency (frequency analysis)			Source	Measures
FFT of original wave		FFT after envelope (basic No.)		
Radial (angular) direction	Axial direction			
$f_{RIN} \cdot f_{MI}$	$f_{AIN} \cdot f_{AM}$	—	Selective resonance of waviness (rolling friction)	Improve rigidity around the bearings, appropriate radial clearance, high-viscosity lubricant, high-quality bearings
$f_{RIN} \cdot f_{MI}$	$f_{AIN} \cdot f_{AM}$	Zf_c	Collision of rolling elements with inner ring or cage	Reduce radial clearance, apply preload, high-viscosity oil
$(\approx f_{R2N} \cdot f_{R3N})$	—	?	Self-induced vibration caused by sliding friction at rolling surface	Reduce radial clearance, apply preload, change the grease, replace with countermeasured bearings
Natural frequency of cage		f_c	Collision of cage with rolling elements or rings	Apply preload, high-viscosity lubricant, reduce mounting error
Natural frequency of cage		?	Self-induced vibration caused by friction at cage guide surface	Change of grease brand, replace with countermeasured cage
Natural frequency of cage		Zf_c	Collision of cage and rolling element caused by grease resistance	Reduce radial clearance, apply preload, low-viscosity lubricant
Zf_c	—	—	Displacement of inner ring due to rolling element passage	Reduce radial clearance, apply preload
$nZf_i \pm f_r$ ($nZ \pm 1$ peaks)	nZf_i (nZ peaks)	—	Inner ring raceway waviness, irregularity of shaft exterior	High-quality bearings, improve shaft accuracy
nZf_c ($nZ \pm 1$ peaks)	nZf_c (nZ peaks)	—	Outer ring raceway waviness, irregular bore of housing	High-quality bearings, improve housing bore accuracy
$2nf_b \pm f_c$ ($2n$ peaks)	$2nf_b$ ($2n$ peaks)	—	Rolling element waviness	High-quality bearings
$f_{RIN} \cdot f_{MI}$	$f_{AIN} \cdot f_{AM}$	Zf_i	Nicks, dents, rust, flaking on inner ring raceway	Replacement and careful bearing handling
		Zf_c	Nicks, dents, rust, flaking on inner ring raceway	Replacement and careful bearing handling
		$2f_b$	Nicks, dents, rust, flaking on rolling elements	Replacement and careful bearing handling
$f_{RIN} \cdot f_{MI}$	$f_{AIN} \cdot f_{AM}$	Irregular	Entry of dirt and debris	Washing, improve sealing
Natural frequency of seal		(f_p)	Self-induced vibration due to friction at seal contact area	Change the seal, change the grease
?	?	Irregular	Lubricant or lubricant bubbles crushed between rolling elements and raceways	Change the grease
f_r	—	—	Irregular inner ring cross-section	High-quality bearings
f_c	—	—	Ball variation in bearing, rolling elements non-equidistant	High-quality bearings
$f_r - 2f_c$	—	—	Non-linear vibration due to rigid variation by ball variation	High-quality bearings

f_c : Orbital revolution frequency of rolling elements, Hz
 f_{AIN} : Ring natural frequency in axial bending mode, Hz
 f_{AM} : Natural frequency in the mode of axial vibration in mass of outer ring-spring system, Hz
 f_i : $f_i = f_r - f_c$, Hz
 f_b : Rotation frequency of rolling element around its center, Hz

How to record sound and vibration waveforms

Through frequency analyses of sound or vibration of a rotating machine, it is possible to infer the cause of abnormal vibration. We will describe here how to record vibrations using Bearing Monitor NB-4 (see Page 128) and how to record sounds using

a microphone.

Sounds and vibrations should be recorded under both normal and abnormal conditions, to determine the cause of irregularities.

Fig. 2.1 Configuration for recording sound and vibration waveforms

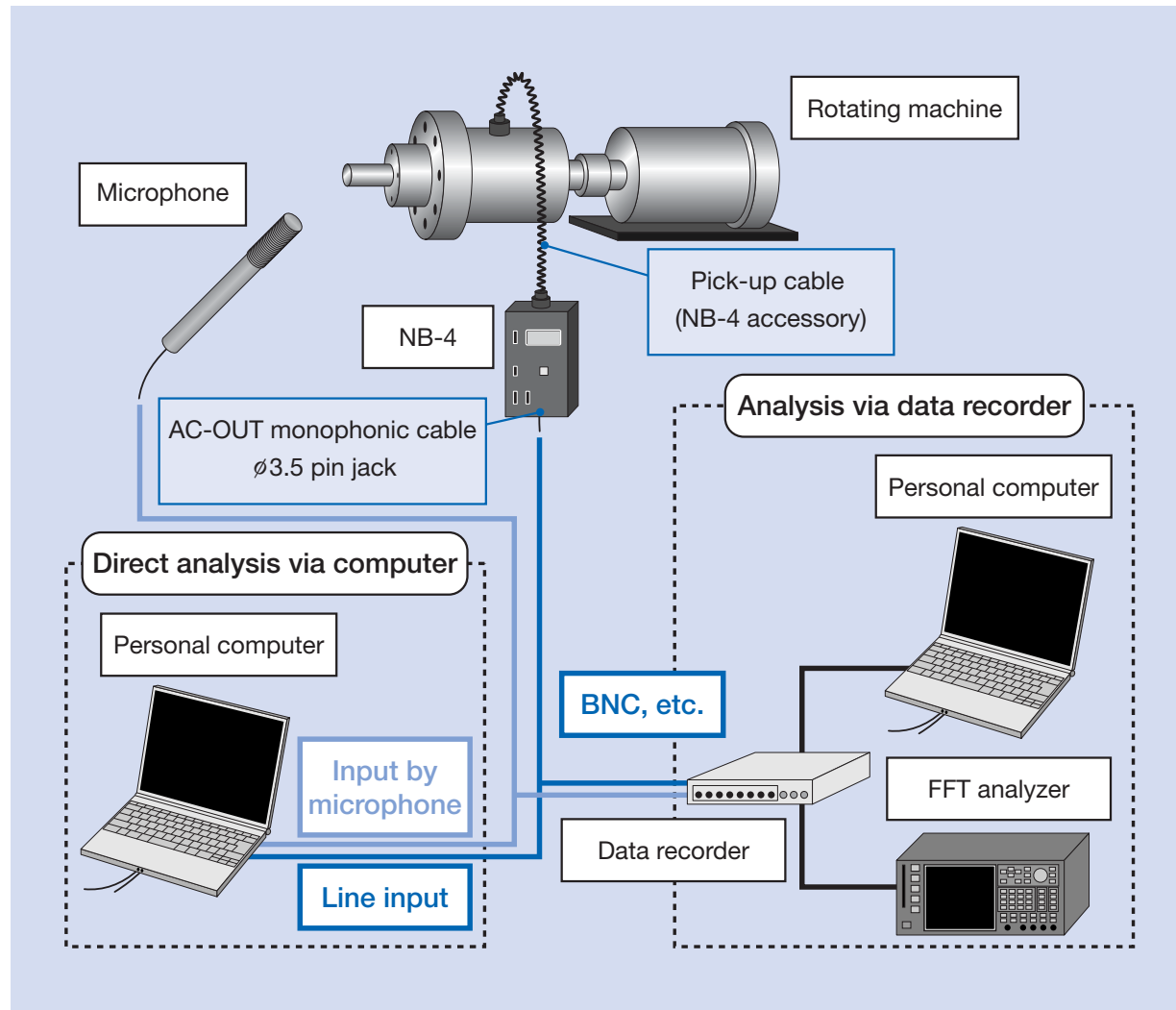

Cautions for recording sound and vibration waveforms

Analyzing data after recording is easy provided the following precautions are taken.

- 1) Stop operation of nearby machines to cut off ambient noise and vibration.
- 2) Collect sound and vibration data under both normal and abnormal conditions.
- 3) Listen to a playback of recorded sounds to check for irregularities.
- 4) Collect sound and vibration data while changing the number of rotations of the machine (for example, 100 min⁻¹, 800 min⁻¹, and 2 000 min⁻¹).

How to record vibrations when recording the waveform directly by a computer

Required equipment:

- Bearing Monitor NB-4
- Personal computer (with line-input terminal and waveform recording software)
- Monophonic cable for waveform data recording (ø3.5 pin jack at one end)

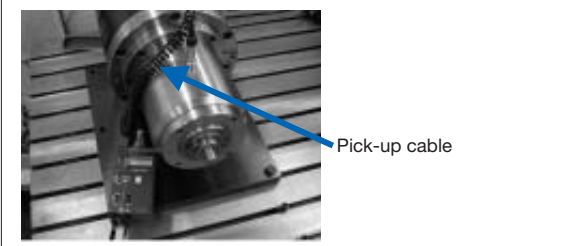

Connect the pick-up cable to Bearing Monitor NB-4 and then attach the pick-up terminal to the machine to be measured. To measure vibration, it is best to attach the pick-up terminal to a spot near a bearing in the machine.

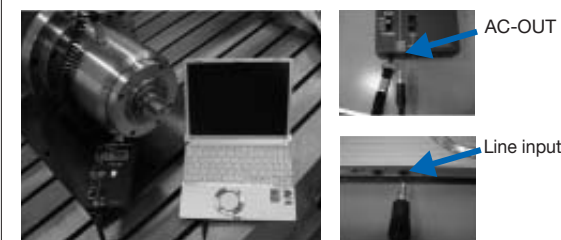

Connect NB-4 (AC-OUT) and recording equipment (in the left picture, the microphone input of a personal computer*) using a monophonic cable (ø3.5 pin-jack at NB-4 side).

*1 A microphone input terminal can be used as a substitute, although depending on the magnitude of vibration, it may not be able to handle input that falls outside of a given range.

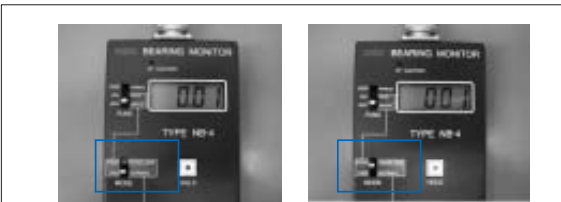

Set NB-4 to ACC-NORMAL when measuring rotation vibrations of a machine. Set NB-4 to ACC-ENVELOPE (envelope analysis*) when measuring vibrations due to a scratch in a bearing.

Start recording vibration waveform data using audio recording software. Adjust recording level of the personal computer to maintain input signals within a given range. Recording for at least 20 seconds is recommended.

Save recorded vibration waveform data. (Be aware that some vibration data may be lost depending on the file format.)

Analyze recorded vibration waveform data to check for irregular vibration.

*2 Envelope analysis

Damage in the raceway surface or rolling element may produce impact vibration at regular intervals. In this case, FFT analysis of vibration waveforms cannot detect the frequency components generated by the damage. Under these circumstances, envelope analysis, which gives envelope delay distortion to original waveforms to analyze frequencies, can detect these frequency components. For envelope analysis, equipment needs to have an envelope processing function.

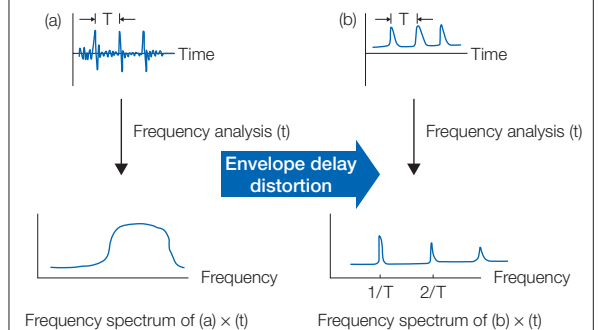

How to record sounds when recording directly by a computer

Required equipment:

- Microphone for measuring sound
- Personal computer (equipped with a microphone input terminal and audio recording software)

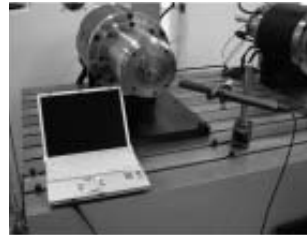

Connect a microphone to recording equipment. We recommend a microphone with frequency characteristics*3 that effectively record the sounds of a machine. A microphone for measuring sound should be used because a microphone built into a personal computer is suitable for recording human voices but is often not appropriate for recording the sounds of a machine.



Keep the microphone at an appropriate distance from the rotating machine being inspected. (If too close, sounds of entangled air will be recorded, and if too distant, sound level will be too low.) It is recommended to stop operation of nearby machines to cut off the ambient noise, which makes it difficult to analyze recorded noise. Use a unidirectional microphone, if available, to cut off ambient noises.

Start recording with recording equipment. Adjust recording level of the personal computer to maintain input signals within a given range.

Save recorded sound data. (Be aware that some vibration data may be lost depending on the file format.)

Listen to a playback of recorded sounds to check for irregular noise.

*3 Microphone frequency characteristics

Frequency characteristics vary by type of microphone. For example, at 60Hz or less, the microphone (see Fig. 2.2) exhibits low sensitivity while the other microphone (see Fig. 2.3) exhibits stable characteristics for maintaining good sensitivity across a wide range of frequency bands. Therefore, the microphone Fig. 2.3 is suitable for measuring sounds of a machine due to its stable characteristics across a wide range of frequency bands.

Fig. 2.2

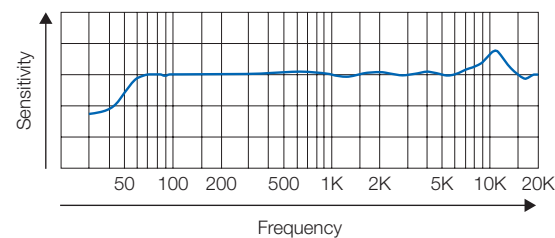
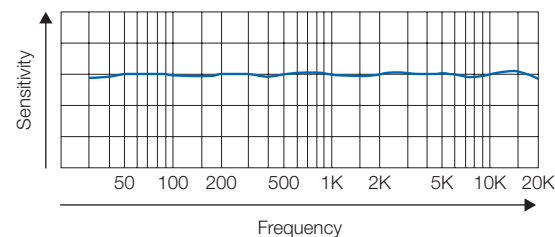

Fig. 2.3



Sounds recorded in this way and saved as a WAV file can be frequency-analyzed by using commercially available FFT software. Vibration or sound frequencies associated with damage such as scratching or waviness on the bearing raceway surface can be obtained as seen in Fig 2.4. When these frequency components are found as a result of frequency analysis conducted with FFT software, the bearing surface may be damaged. Upon request,

NSK will be able to analyze sounds stored as a WAV file. When such a request is made, NSK will need recorded sounds under both normal and abnormal conditions. Note that frequency analysis of sounds and vibration waveforms of a rotating machine may not be possible (Note that frequency analysis of sounds and vibration waveforms of a rotating machine may not be possible) when the recording conditions are not sufficiently fulfilled.

Fig. 2.4 Examples of Results of Sound and Vibration Frequency Analysis Conducted with FFT Software

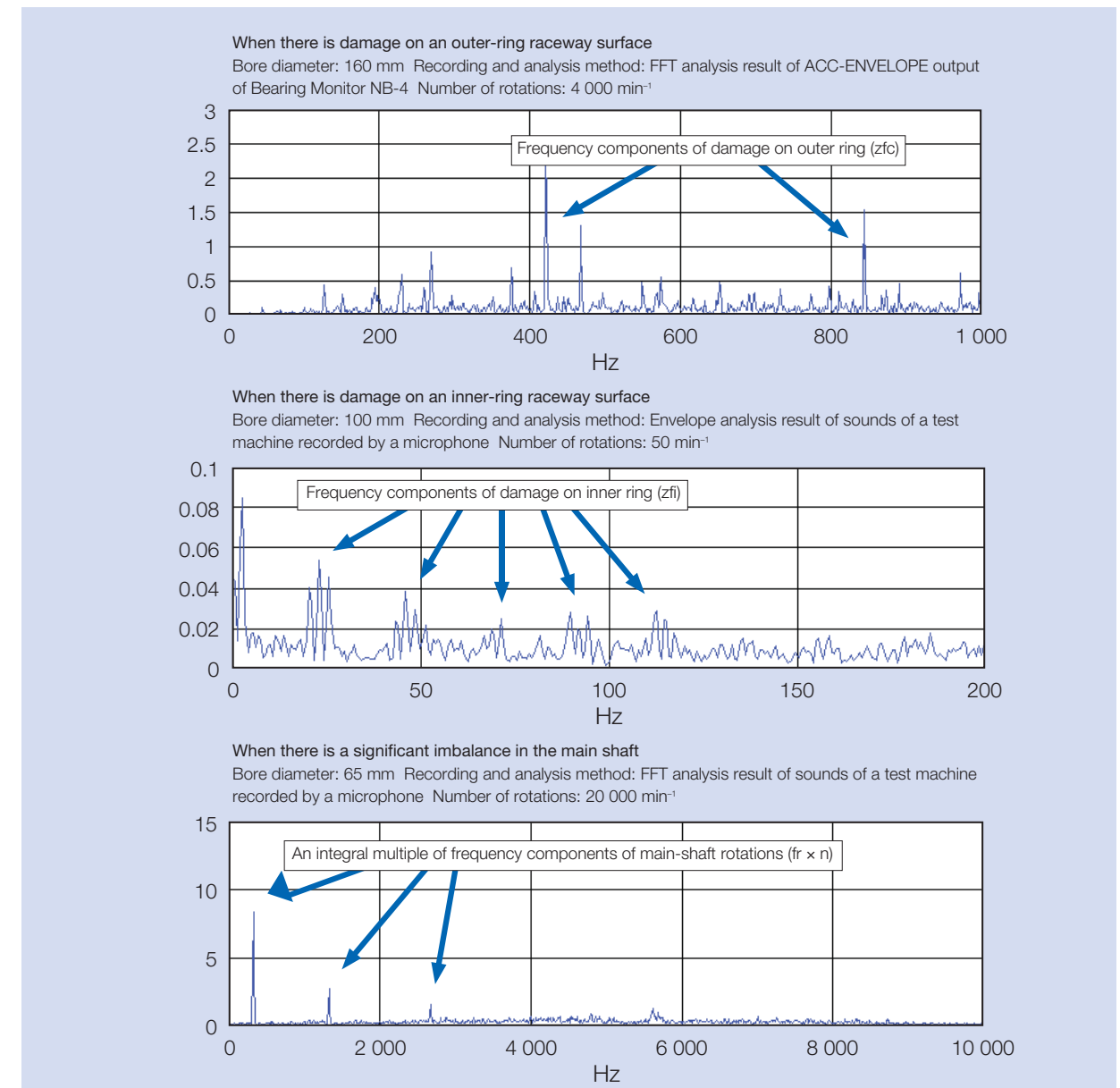



Appendices

Tolerances for Shaft Diameters	P228-229
Tolerances for Housing Bore Diameters	P230-231
Values of Standard Tolerances for IT Grades	P232-233
Hardness Conversion Table	P234
Physical and Mechanical Properties of Material	P235-236
Old and New Number Contrast Table	P237
Method for Measuring Axial Clearance of Combined Angular Contact Ball Bearings	P238
Request for Specification Investigation	P240

Appendices

Tolerances for Shaft Diameters

Diameter classification (mm)		d6	e6	f6	g5	g6	h5	h6	h7	h8	h9	h10	js5	js6
over	incl													
3	6	-30 -38	-20 -28	-10 -18	-4 -9	-4 -12	0 -5	0 -8	0 -12	0 -18	0 -30	0 -48	± 2.5	± 4
6	10	-40 -49	-25 -34	-13 -22	-5 -11	-5 -14	0 -6	0 -9	0 -15	0 -22	0 -36	0 -58	± 3	± 4.5
10	18	-50 -61	-32 -43	-16 -27	-6 -14	-6 -17	0 -8	0 -11	0 -18	0 -27	0 -43	0 -70	± 4	± 5.5
18	30	-65 -78	-40 -53	-20 -33	-7 -16	-7 -20	0 -9	0 -13	0 -21	0 -33	0 -52	0 -84	± 4.5	± 6.5
30	50	-80 -96	-50 -66	-25 -41	-9 -20	-9 -25	0 -11	0 -16	0 -25	0 -39	0 -62	0 -100	± 5.5	± 8
50	80	-100 -119	-60 -79	-30 -49	-10 -23	-10 -29	0 -13	0 -19	0 -30	0 -46	0 -74	0 -120	± 6.5	± 9.5
80	120	-120 -142	-72 -94	-36 -58	-12 -27	-12 -34	0 -15	0 -22	0 -35	0 -54	0 -87	0 -140	± 7.5	± 11
120	180	-145 -170	-85 -110	-43 -68	-14 -32	-14 -39	0 -18	0 -25	0 -40	0 -63	0 -100	0 -160	± 9	± 12.5
180	250	-170 -199	-100 -129	-50 -79	-15 -35	-15 -44	0 -20	0 -29	0 -46	0 -72	0 -115	0 -185	± 10	± 14.5
250	315	-190 -222	-110 -142	-56 -88	-17 -40	-17 -49	0 -23	0 -32	0 -52	0 -81	0 -130	0 -210	± 11.5	± 16
315	400	-210 -246	-125 -161	-62 -98	-18 -43	-18 -54	0 -25	0 -36	0 -57	0 -89	0 -140	0 -230	± 12.5	± 18
400	500	-230 -270	-135 -175	-68 -108	-20 -47	-20 -60	0 -27	0 -40	0 -63	0 -97	0 -155	0 -250	± 13.5	± 20
500	630	-260 -304	-145 -189	-76 -120	-	-22 -66	-	0 -44	0 -70	0 -110	0 -175	0 -280	-	± 22
630	800	-290 -340	-160 -210	-80 -130	-	-24 -74	-	0 -50	0 -80	0 -125	0 -200	0 -320	-	± 25
800	1 000	-320 -376	-170 -226	-86 -142	-	-26 -82	-	0 -56	0 -90	0 -140	0 -230	0 -360	-	± 28
1 000	1 250	-350 -416	-195 -261	-98 -164	-	-28 -94	-	0 -66	0 -105	0 -165	0 -260	0 -420	-	± 33
1 250	1 600	-390 -468	-220 -298	-110 -188	-	-30 -108	-	0 -78	0 -125	0 -195	0 -310	0 -500	-	± 39
1 600	2 000	-430 -522	-240 -332	-120 -212	-	-32 -124	-	0 -92	0 -150	0 -230	0 -370	0 -600	-	± 46

Unit: µm

j5	j6	j7	k5	k6	k7	m5	m6	n6	p6	r6	r7	Diameter classification (mm)	
												over	incl
+3 -2	+6 -2	+8 -4	+6 +1	+9 +1	+13 +1	+9 +4	+12 +4	+16 +8	+20 +12	+23 +15	+27 +15	3	6
+4 -2	+7 -2	+10 -5	+7 +1	+10 +1	+16 +1	+12 +6	+15 +6	+19 +10	+24 +15	+28 +19	+34 +19	6	10
+5 -3	+8 -3	+12 -6	+9 +1	+12 +1	+19 +1	+15 +7	+18 +7	+23 +12	+29 +18	+34 +23	+41 +23	10	18
+5 -4	+9 -4	+13 -8	+11 +2	+15 +2	+23 +2	+17 +8	+21 +8	+28 +15	+35 +22	+41 +28	+49 +28	18	30
+6 -5	+11 -5	+15 -10	+13 +2	+18 +2	+27 +2	+20 +9	+25 +9	+33 +17	+42 +26	+50 +34	+59 +34	30	50
+6 -7	+12 -7	+18 -12	+15 +2	+21 +2	+32 +2	+24 +11	+30 +11	+39 +20	+51 +32	+60 +43	+71 +43	50	65
+6 -7	+12 -7	+18 -12	+15 +2	+21 +2	+32 +2	+24 +11	+30 +11	+39 +20	+51 +32	+60 +43	+71 +43	65	80
+6 -9	+13 -9	+20 -15	+18 +3	+25 +3	+38 +3	+28 +13	+35 +13	+45 +23	+59 +37	+73 +54	+86 +54	80	100
+6 -9	+13 -9	+20 -15	+18 +3	+25 +3	+38 +3	+28 +13	+35 +13	+45 +23	+59 +37	+73 +54	+86 +54	100	120
+7 -11	+14 -11	+22 -18	+21 +3	+28 +3	+43 +3	+33 +15	+40 +15	+52 +27	+68 +43	+88 +63	+103 +63	120	140
+7 -11	+14 -11	+22 -18	+21 +3	+28 +3	+43 +3	+33 +15	+40 +15	+52 +27	+68 +43	+90 +65	+105 +65	140	160
+7 -11	+14 -11	+22 -18	+21 +3	+28 +3	+43 +3	+33 +15	+40 +15	+52 +27	+68 +43	+93 +68	+108 +68	160	180
+7 -13	+16 -13	+25 -21	+24 +4	+33 +4	+50 +4	+37 +17	+46 +17	+60 +31	+79 +50	+106 +77	+123 +77	180	200
+7 -13	+16 -13	+25 -21	+24 +4	+33 +4	+50 +4	+37 +17	+46 +17	+60 +31	+79 +50	+109 +80	+126 +80	200	225
+7 -13	+16 -13	+25 -21	+24 +4	+33 +4	+50 +4	+37 +17	+46 +17	+60 +31	+79 +50	+113 +84	+130 +84	225	250
+7 -16	+16 -16	+26 -26	+27 +4	+36 +4	+56 +4	+43 +20	+52 +20	+66 +34	+88 +56	+126 +94	+146 +94	250	280
+7 -16	+16 -16	+26 -26	+27 +4	+36 +4	+56 +4	+43 +20	+52 +20	+66 +34	+88 +56	+130 +98	+150 +98	280	315
+7 -18	+18 -18	+29 -28	+29 +4	+40 +4	+61 +4	+46 +21	+57 +21	+73 +37	+98 +62	+144 +108	+165 +108	315	355
+7 -18	+18 -18	+29 -28	+29 +4	+40 +4	+61 +4	+46 +21	+57 +21	+73 +37	+98 +62	+150 +114	+171 +114	355	400
+7 -20	+20 -20	+31 -32	+32 +5	+45 +5	+68 +5	+50 +23	+63 +23	+80 +40	+108 +68	+166 +126	+189 +126	400	450
+7 -20	+20 -20	+31 -32	+32 +5	+45 +5	+68 +5	+50 +23	+63 +23	+80 +40	+108 +68	+172 +132	+195 +132	450	500
-	-	-	-	+44 0	+70 0	-	+70 +26	+88 +44	+122 +78	+194 +150	+220 +150	500	560
-	-	-	-	+44 0	+70 0	-	+70 +26	+88 +44	+122 +78	+199 +155	+225 +155	560	630
-	-	-	-	+50 0	+80 0	-	+80 +30	+100 +50	+138 +88	+225 +175	+255 +175	630	710
-	-	-	-	+50 0	+80 0	-	+80 +30	+100 +50	+138 +88	+235 +185	+265 +185	710	800
-	-	-	-	+56 0	+90 0	-	+90 +34	+112 +56	+156 +100	+266 +210	+300 +210	800	900
-	-	-	-	+56 0	+90 0	-	+90 +34	+112 +56	+156 +100	+276 +220	+310 +220	900	1 000
-	-	-	-	+66 0	+105 0	-	+106 +40	+132 +66	+186 +120	+316 +250	+355 +250	1 000	1 120
-	-	-	-	+66 0	+105 0	-	+106 +40	+132 +66	+186 +120	+326 +260	+365 +260	1 120	1 250
-	-	-	-	+78 0	+125 0	-	+126 +48	+156 +78	+218 +140	+378 +300	+425 +300	1 250	1 400
-	-	-	-	+78 0	+125 0	-	+126 +48	+156 +78	+218 +140	+408 +330	+455 +330	1 400	1 600
-	-	-	-	+92 0	+150 0	-	+150 +58	+184 +92	+262 +170	+462 +370	+520 +370	1 600	1 800
-	-	-	-	+92 0	+150 0	-	+150 +58	+184 +92	+262 +170	+492 +400	+550 +400	1 800	2 000

Tolerances for Housing Bore Diameters

Diameter classification (mm)		E6	F6	F7	G6	G7	H6	H7	H8	J6	J7	JS6	JS7
over	incl												
10	18	+43 +32	+27 +16	+34 +16	+17 +6	+24 +6	+11 0	+18 0	+27 0	+6 -5	+10 -8	±5.5	±9
18	30	+53 +40	+33 +20	+41 +20	+20 +7	+28 +7	+13 0	+21 0	+33 0	+8 -5	+12 -9	±6.5	±10.5
30	50	+66 +50	+41 +25	+50 +25	+25 +9	+34 +9	+16 0	+25 0	+39 0	+10 -6	+14 -11	±8	±12.5
50	80	+79 +60	+49 +30	+60 +30	+29 +10	+40 +10	+19 0	+30 0	+46 0	+13 -6	+18 -12	±9.5	±15
80	120	+94 +72	+58 +36	+71 +36	+34 +12	+47 +12	+22 0	+35 0	+54 0	+16 -6	+22 -13	±11	±17.5
120	180	+110 +85	+68 +43	+83 +43	+39 +14	+54 +14	+25 0	+40 0	+63 0	+18 -7	+26 -14	±12.5	±20
180	250	+129 +100	+79 +50	+96 +50	+44 +15	+61 +15	+29 0	+46 0	+72 0	+22 -7	+30 -16	±14.5	±23
250	315	+142 +110	+88 +56	+108 +56	+49 +17	+69 +17	+32 0	+52 0	+81 0	+25 -7	+36 -16	±16	±26
315	400	+161 +125	+98 +62	+119 +62	+54 +18	+75 +18	+36 0	+57 0	+89 0	+29 -7	+39 -18	±18	±28.5
400	500	+175 +135	+108 +68	+131 +68	+60 +20	+83 +20	+40 0	+63 0	+97 0	+33 -7	+43 -20	±20	±31.5
500	630	+189 +145	+120 +76	+146 +76	+66 +22	+92 +22	+44 0	+70 0	+110 0	-	-	±22	±35
630	800	+210 +160	+130 +80	+160 +80	+74 +24	+104 +24	+50 0	+80 0	+125 0	-	-	±25	±40
800	1 000	+226 +170	+142 +86	+176 +86	+82 +26	+116 +26	+56 0	+90 0	+140 0	-	-	±28	±45
1 000	1 250	+261 +195	+164 +98	+203 +98	+94 +28	+133 +28	+66 0	+105 0	+165 0	-	-	±33	±52.5
1 250	1 600	+298 +220	+188 +110	+235 +110	+108 +30	+155 +30	+78 0	+125 0	+195 0	-	-	±39	±62.5
1 600	2 000	+332 +240	+212 +120	+270 +120	+124 +32	+182 +32	+92 0	+150 0	+230 0	-	-	±46	±75
2 000	2 500	+370 +260	+240 +130	+305 +130	+144 +34	+209 +34	+110 0	+175 0	+280 0	-	-	±55	±87.5

Unit: µm

K5	K6	K7	M5	M6	M7	N5	N6	N7	P6	P7	Diameter classification (mm)	
											over	incl
+2 -6	+2 -9	+6 -12	-4 -12	-4 -15	0 -18	-9 -17	-9 -20	-5 -23	-15 -26	-11 -29	10	18
+1 -8	+2 -11	+6 -15	-5 -14	-4 -17	0 -21	-12 -21	-11 -24	-7 -28	-18 -31	-14 -35	18	30
+2 -9	+3 -13	+7 -18	-5 -16	-4 -20	0 -25	-13 -24	-12 -28	-8 -33	-21 -37	-17 -42	30	50
+3 -10	+4 -15	+9 -21	-6 -19	-5 -24	0 -30	-15 -28	-14 -33	-9 -39	-26 -45	-21 -51	50	80
+2 -13	+4 -18	+10 -25	-8 -23	-6 -28	0 -35	-18 -33	-16 -38	-10 -45	-30 -52	-24 -59	80	120
+3 -15	+4 -21	+12 -28	-9 -27	-8 -33	0 -40	-21 -39	-20 -45	-12 -52	-36 -61	-28 -68	120	180
+2 -18	+5 -24	+13 -33	-11 -31	-8 -37	0 -46	-25 -45	-22 -51	-14 -60	-41 -70	-33 -79	180	250
+3 -20	+5 -27	+16 -36	-13 -36	-9 -41	0 -52	-27 -50	-25 -57	-14 -66	-47 -79	-36 -88	250	315
+3 -22	+7 -29	+17 -40	-14 -39	-10 -46	0 -57	-30 -55	-26 -62	-16 -73	-51 -87	-41 -98	315	400
+2 -25	+8 -32	+18 -45	-16 -43	-10 -50	0 -63	-33 -60	-27 -67	-17 -80	-55 -95	-45 -108	400	500
-	0 -44	0 -70	-	-26 -70	-26 -96	-	-44 -88	-44 -114	-78 -122	-78 -148	500	630
-	0 -50	0 -80	-	-30 -80	-30 -110	-	-50 -100	-50 -130	-88 -138	-88 -168	630	800
-	0 -56	0 -90	-	-34 -90	-34 -124	-	-56 -112	-56 -146	-100 -156	-100 -190	800	1 000
-	0 -66	0 -105	-	-40 -106	-40 -145	-	-66 -132	-66 -171	-120 -186	-120 -225	1 000	1 250
-	0 -78	0 -125	-	-48 -126	-48 -173	-	-78 -156	-78 -203	-140 -218	-140 -265	1 250	1 600
-	0 -92	0 -150	-	-58 -150	-58 -208	-	-92 -184	-92 -242	-170 -262	-170 -320	1 600	2 000
-	0 -110	0 -175	-	-68 -178	-68 -243	-	-110 -220	-110 -285	-195 -305	-195 -370	2 000	2 500

Values of Standard Tolerances for IT Grades

Basic size (mm)		Standard grade								
		IT1	IT2	IT3	IT4	IT5	IT6	IT7	IT8	IT9
over	incl	Tolerances (μm)								
–	3	0.8	1.2	2	3	4	6	10	14	25
3	6	1	1.5	2.5	4	5	8	12	18	30
6	10	1	1.5	2.5	4	6	9	15	22	36
10	18	1.2	2	3	5	8	11	18	27	43
18	30	1.5	2.5	4	6	9	13	21	33	52
30	50	1.5	2.5	4	7	11	16	25	39	62
50	80	2	3	5	8	13	19	30	46	74
80	120	2.5	4	6	10	15	22	35	54	87
120	180	3.5	5	8	12	18	25	40	63	100
180	250	4.5	7	10	14	20	29	46	72	115
250	315	6	8	12	16	23	32	52	81	130
315	400	7	9	13	18	25	36	57	89	140
400	500	8	10	15	20	27	40	63	97	155
500	630	9	11	16	22	32	44	70	110	175
630	800	10	13	18	25	36	50	80	125	200
800	1 000	11	15	21	28	40	56	90	140	230
1 000	1 250	13	18	24	33	47	66	105	165	260
1 250	1 600	15	21	29	39	55	78	125	195	310
1 600	2 000	18	25	35	46	65	92	150	230	370
2 000	2 500	22	30	41	55	78	110	175	280	440
2 500	3 150	26	36	50	68	96	135	210	330	540

Standard grade									Basic size (mm)	
IT10	IT11	IT12	IT13	IT14	IT15	IT16	IT17	IT18		
Tolerances (μm)									over	incl
40	60	0.10	0.14	0.25	0.40	0.60	1.00	1.40	–	3
48	75	0.12	0.18	0.30	0.48	0.75	1.20	1.80	3	6
58	90	0.15	0.22	0.36	0.58	0.90	1.50	2.20	6	10
70	110	0.18	0.27	0.43	0.70	1.10	1.80	2.70	10	18
84	130	0.21	0.33	0.52	0.84	1.30	2.10	3.30	18	30
100	160	0.25	0.39	0.62	1.00	1.60	2.50	3.90	30	50
120	190	0.30	0.46	0.74	1.20	1.90	3.00	4.60	50	80
140	220	0.35	0.54	0.87	1.40	2.20	3.50	5.40	80	120
160	250	0.40	0.63	1.00	1.60	2.50	4.00	6.30	120	180
185	290	0.46	0.72	1.15	1.85	2.90	4.60	7.20	180	250
210	320	0.52	0.81	1.30	2.10	3.20	5.20	8.10	250	315
230	360	0.57	0.89	1.40	2.30	3.60	5.70	8.90	315	400
250	400	0.63	0.97	1.55	2.50	4.00	6.30	9.70	400	500
280	440	0.70	1.10	1.75	2.80	4.40	7.00	11.00	500	630
320	500	0.80	1.25	2.00	3.20	5.00	8.00	12.50	630	800
360	560	0.90	1.40	2.30	3.60	5.60	9.00	14.00	800	1 000
420	660	1.05	1.65	2.60	4.20	6.60	10.50	16.50	1 000	1 250
500	780	1.25	1.95	3.10	5.00	7.80	12.50	19.50	1 250	1 600
600	920	1.50	2.30	3.70	6.00	9.20	15.00	23.00	1 600	2 000
700	1 100	1.75	2.80	4.40	7.00	11.00	17.50	28.00	2 000	2 500
860	1 350	2.10	3.30	5.40	8.60	13.50	21.00	33.00	2 500	3 150

Remarks 1. Standard tolerance grades IT14 to IT18 shall not be used for basic sizes less than or equal to 1 mm.
 2. Values for standard tolerance grades IT1 to IT5 for basic size over 500 mm are included for experimental use.

Hardness Conversion Table (Reference)

Rockwell C scale hardness (1471N)	Vickers hardness	Brinell hardness		Rockwell hardness		Shore hardness
		Standard ball	Tungsten Carbide ball	A scale Load 588.4N Brale indenter	B scale Load 980.7N 1.588 mm Ball	
68	940	-	-	85.6	-	97
67	900	-	-	85.0	-	95
66	865	-	-	84.5	-	92
65	832	-	739	83.9	-	91
64	800	-	722	83.4	-	88
63	772	-	705	82.8	-	87
62	746	-	688	82.3	-	85
61	720	-	670	81.8	-	83
60	697	-	654	81.2	-	81
59	674	-	634	80.7	-	80
58	653	-	615	80.1	-	78
57	633	-	595	79.6	-	76
56	613	-	577	79.0	-	75
55	595	-	560	78.5	-	74
54	577	-	543	78.0	-	72
53	560	-	525	77.4	-	71
52	544	500	512	76.8	-	69
51	528	487	496	76.3	-	68
50	513	475	481	75.9	-	67
49	498	464	469	75.2	-	66
48	484	451	455	74.7	-	64
47	471	442	443	74.1	-	63
46	458	432	432	73.6	-	62
45	446	421	421	73.1	-	60
44	434	409	409	72.5	-	58
43	423	400	400	72.0	-	57
42	412	390	390	71.5	-	56
41	402	381	381	70.9	-	55
40	392	371	371	70.4	-	54
39	382	362	362	69.9	-	52
38	372	353	353	69.4	-	51
37	363	344	344	68.9	-	50
36	354	336	336	68.4	(109.0)	49
35	345	327	327	67.9	(108.5)	48
34	336	319	319	67.4	(108.0)	47
33	327	311	311	66.8	(107.5)	46
32	318	301	301	66.3	(107.0)	44
31	310	294	294	65.8	(106.0)	43
30	302	286	286	65.3	(105.5)	42
29	294	279	279	64.7	(104.5)	41
28	286	271	271	64.3	(104.0)	41
27	279	264	264	63.8	(103.0)	40
26	272	258	258	63.3	(102.5)	38
25	266	253	253	62.8	(101.5)	38
24	260	247	247	62.4	(101.0)	37
23	254	243	243	62.0	100.0	36
22	248	237	237	61.5	99.0	35
21	243	231	231	61.0	98.5	35
20	238	226	226	60.5	97.8	34
(18)	230	219	219	-	96.7	33
(16)	222	212	212	-	95.5	32
(14)	213	203	203	-	93.9	31
(12)	204	194	194	-	92.3	29
(10)	196	187	187	-	90.7	28
(8)	188	179	179	-	89.5	27
(6)	180	171	171	-	87.1	26
(4)	173	165	165	-	85.5	25
(2)	166	158	158	-	83.5	24
(0)	160	152	152	-	81.7	24

Physical and Mechanical Properties of Material

Application	Material code	Heat treatment	Density g/cm ³	Specific heat KJ/(kg·K)	Thermal conductivity W/(m·K)	Electric resistance μΩ·cm	Coefficient of linear expansion (0°-100°C) ×10 ⁻⁶ /°C	Young's modulus MPa	Yield point MPa	Tensile strength MPa	Elongation %	Hardness HB	Remarks			
Bearing	SUJ2	Hardening, tempering	7.83	0.47	46	22	12.5	208 000	1 370	1 570 -1 960	Max. 0.5	650 -740	High-carbon chromium bearing steel type 2			
	SUJ2	Spheroidizing tempering	7.86				11.9							420	647	27
	SCr420	Hardening, low temperature tempering	7.83		48	21	12.8		902	1 225	15	370	Chromium steel			
	SAE4320 (SNCM420)	Hardening, low temperature tempering			44	20	11.7							1 009	16	**293 -375
	SNCM815	Hardening, low temperature tempering	7.89		40	35	-		-	Min. *1 080	Min. *12	*311 -375	Nickel-chromium-molybdenum steel			
	SUS440C	Hardening, low temperature tempering	7.68		0.46	24	60		10.1	200 000	1 860	1 960	-	**580	Martensitic stainless steel	
	SPCC	Annealing	7.86		0.47	59	15		11.6	206 000	-	Min. *275	Min. *32	-	Cold-rolled steel	
	S25C	Annealing			0.48	50	17		11.8		323	431	33	120	Carbon steel for machine structure use	
	HB _s C1				8.5	0.38	123		6.2	19.1	103 000	-	Min. *431	Min. *20	-	High-strength brass casting

Notes *Standard value of JIS or reference value.
 **The hardness is usually expressed using the Rockwell C scale, but for comparison, it is converted into Brinell hardness.
 Reference Proportional limits of SUJ2 and SCr420 are 833 MPa (85kgf/mm²) and 440 MPa (45kgf/mm²) respectively.

Physical and Mechanical Properties of Material

Application	Material code	Heat treatment	Density g/cm ³	Specific heat KJ/(kg·K)	Thermal conductivity W/(m·K)	Electric resistance μΩ·cm	Coefficient of linear expansion (0°-100°C) ×10 ⁻⁶ /°C	Young's modulus MPa	Yield point MPa	Tensile strength MPa	Elongation %	Hardness HB	Remarks			
Shaft	S45C	Hardening, 650 tempering	7.83	0.48	47	18	12.8	207 000	440	735	25	217	Carbon steel for machine structure use			
	SCr430	Hardening, 520-62 quenching				22	12.5	Min. *637	Min. *784	Min. *18	*229 -293	Chromium steel				
	SCr440	Hardening, 520-620 quenching				23		Min. *784	Min. *930	Min. *13	*269 -331	Chromium steel				
	SCM420	Hardening, 150-200 quenching				0.47	48	21	12.8	-	Min. *930	Min. *14	*262 -352	Chromium-molybdenum steel		
	SNM439	Hardening, 650 tempering					38	30	11.3	207 000	920	1 030	18	320	Nickel-chromium-molybdenum steel	
	SC46	Normalizing				-	-	-	-	-	206 000	294	520	27	143	Low carbon steel
	SUS420J2	1038 oil cooling, 400 air cooling				7.75	0.46	22	55	10.4	200 000	1 440	1 650	10	400	Martensitic stainless steel
	FC200	N/A				7.3	0.50	43	-		-	Min. *200	-	Max. *217	Gray iron	
	FCD400	N/A				7.0	0.48	20	-	11.7	98 000	Min. *250	Min. *400	Min. *12	Max. *201	Ductile iron
	A1100	Annealing				2.69	0.90	222	3.0	23.7		70 000	34	78	35	-
AC4C	N/A	2.68	0.88	151	4.2	21.5	72 000	88	167	7	-	Sand casting aluminum alloy				
ADC10	N/A	2.74	0.96	96	7.5	22.0	71 000	167	323	4	-	Die casting aluminum alloy				
SUS304	Annealing	8.03	0.50	15	72	15.7-16.8	193 000	245	588	60	150	Austenitic stainless steel				

Notes *Standard value of JIS or reference value.

**Hardness is usually expressed using the Rockwell C Scale, but for comparison, it is converted into Brinell hardness.

Reference Proportional limits of SUJ2 and Scr420 are 833 MPa (85kgf/mm²) and 440 MPa (45kgf/mm²) respectively.

Old and New Number Contrast Table

Bearings	New name	Old name	Notes
High Precision Angular Contact Ball Bearings	79xxCTYNDBL	79xxCTYDBC7	TYN: Ball guided polyamide 46 resin cage TY: Ball guided polyamide 66 resin cage
	70xxCTYNDBL	70xxCTYDBC7	
	72xxCTYNDBL	72xxCTYDBC7	EL←C2, L←C7
	70xxATYNDBL	70xxATYDBC7	M←C8, H←C9
	72xxATYNDBL	72xxATYDBC7	
	79xxA5TYN	79xxA5TY	
	Ultra High-Speed Angular Contact Ball Bearings	xxBNR19STYN	xxBNC19TY
xxBNR10STYN		xxBNC10TY	
xxBNR19HTYN		xxBNC19SN24TY	
Ultra High Precision Angular Contact Ball Bearings	xxBGR10S	xxBNT10F	BGR: Non-separable type BNT: separable type
	xxBGR10H	xxBNT10FSN24	
Double Row Cylindrical Roller Bearings	NN30xxTB	NN30xxT	TB: Roller guided PPS resin cage TP: Outer ring guided PEEK resin cage T: Roller guided polyamide66 resin cage
Ultra High-Speed Single Row Cylindrical Roller Bearings	N10xxRSTP	N10xxBT	
Angular Contact Thrust Ball Bearings	xxBAR10STYN	xxBA10XTY	TYN: Ball guided polyamide 46 resin cage TY: Ball guided polyamide 66 resin cage
	xxBTR10STYN	xxBT10XTY	
	xxBAR10S	xxTAC20	TAC20(29): Double-Direction Angular Contact Thrust Ball Bearings
	xxBT19x	xxTAC29	BTR10S, BT19x: Angular Contact Thrust Ball Bearings

Please contact NSK for assistance regarding any other number.

Request for Specification Investigation

To request specification investigation, please contact the nearest NSK office and provide us with the following information:

Request for a specification investigation regarding precision bearings

Name of company _____

● Operating conditions

Type of machine [Machining Center, Lathe, Internal Grinding Machine, Motor, Others ()]

Model number _____

Position of bearing [Main shaft spindle, Ball screw support] [Fixed-end, Free-end]

Main shaft position [Vertical, Horizontal, Other ()]

Bearing type Please circle all that apply.

Angular contact ball bearing [Standard series, ROBUST BNR series, ROBUST BER series, ROBUST BGR series]

Cylindrical roller bearing [Single row cylindrical roller bearing, Ultra high speed ROBUST series Double row cylindrical roller bearing]

Angular contact thrust ball bearing [Main shaft TAC, ROBUST BAR series ROBUST BTR series]

Deep groove ball bearing [High precision deep groove ball bearing for spindle motor]

Ball screw support bearing [For machine tool, For electric injection molding machine]

Arrangement [DB · DBD · DBB · DF · DFD · DFF · Other ()]

NSK bearing number _____

Other maker number _____

Bore	_____ mm	Outer diameter	_____ mm	Overall wide	_____ mm
Outer ring width	_____ mm	Inner ring width	_____ mm	Accuracy class	_____ class
Clearance	_____				

● Load condition

Rotating speed	_____ min ⁻¹	Radial load	_____ N	Axial load	_____ N
Moment	_____ N·mm	Unclamp force	_____ N		

● Shaft and housing

Tolerance of shaft	_____	Tolerance of housing	_____	Outer diameter of housing	_____ mm
Material of shaft	_____	Material of housing	_____	Bore diameter of hollow shaft	_____ mm

Driving method	_____	Cooling method	(External cylinder cooling: Yes, No)	Preload type	(Position preload or constant pressure preload)
Spacer length	_____ mm	Ambient temperature	_____ °C		

● Requirement value

Rigidity	_____ N/μm	Preload	_____ N	Life	_____ h
----------	------------	---------	---------	------	---------

● Comments

Please indicate any special requests, questions, or comments here: _____

Attachments: (Yes) (No)

Worldwide Sales Offices and Manufacturing Plants

P: Phone F: Fax C: Country Code Printed in Japan

NSK LTD.-HEADQUARTERS, TOKYO, JAPAN www.nsk.com

Nissei Bldg., 1-6-3 Ohsaki, Shinagawa-ku, Tokyo 141-8560, Japan
INDUSTRIAL MACHINERY BUSINESS DIVISION-HEADQUARTERS
P: 03-3779-7227 F: 03-3779-7644 C: 81
GLOBAL AFTERMARKET DEPARTMENT
P: 03-3779-7253 F: 03-3779-7644 C: 81
PRECISION MACHINERY DEPARTMENT
P: 03-3779-7163 F: 03-3779-7644 C: 81
MECHATRONICS BUSINESS DEPARTMENT
P: 0466-21-3027 F: 0466-21-3206 C: 81
AUTOMOTIVE BUSINESS DIVISION-HEADQUARTERS
P: 03-3779-7189 F: 03-3779-7917 C: 81

●Africa
South Africa:
NSK SOUTH AFRICA (PTY) LTD.
JOHANNESBURG 25 Galaxy Avenue, Linbro Business Park, Sandton, Gauteng, P.O. Box 1157, Kelvin, 2054, South Africa
P: 011-458-3600 F: 011-458-3608 C: 27

●Asia and Oceania
Australia:
NSK AUSTRALIA PTY. LTD. www.au.nsk.com
MELBOURNE 11 Dalmore Drive, Scoresby, Victoria 3179, Australia
P: 03-9764-8302 F: 03-9764-8304 C: 61
SYDNEY 24-28 River Road West, Parramatta, New South Wales 2150, Australia
P: 02-8843-8100 F: 02-9893-8406 C: 61
BRISBANE 1/69 Selhurst Street, Coopers Plains, Queensland 4108, Australia
P: 07-3347-2600 F: 07-3345-5376 C: 61
PERTH Unit 1, 71 Tacoma Circuit, Canning Vale, Western Australia 6155, Australia
P: 08-9256-5000 F: 08-9256-1044 C: 61

China:
NSK HONG KONG LTD.
HONG KONG Suite 814, World Commerce Centre, Harbour City, T.S.T. KLN, Hong Kong, China
P: 02739-9933 F: 02739-9323 C: 852
SHENZHEN Room 8B08-09, Jueshi Tower, Jiabing Road, Luohu, Shenzhen, Guangdong, China (518001)
P: 0755-25904886 F: 0755-25904883 C: 86

KUNSHAN NSK CO., LTD.
OFFICE/PLANT 258 South Huang Pu Jiang Rd., Kunshan Economic & Technical Development Zone, Jiang Su, China (215335)
P: 0512-5771-5654 F: 0512-5771-5689 C: 86

CHANGSHU NSK NEEDLE BEARING CO., LTD.
OFFICE/PLANT No. 66 Dongnan Road, Changshu Southeast Economic Development Zone, Changshu City, Jiangsu, China (215500)
P: 0512-5230-1111 F: 0512-5230-6011 C: 86

NSK STEERING SYSTEMS DONGGUAN CO., LTD.
OFFICE/PLANT High-tech Park, Shilong Road, Guanlong Section, Dongguan, Guangdong, China (523119)
P: 0769-2262-0960 F: 0769-2316-2867 C: 86

ZHANGJIAGANG NSK PRECISION MACHINERY CO., LTD.
OFFICE/PLANT No. 34 Zhenxing Road, Zhangjiagang Economic Development Zone, Zhangjiagang City, Jiangsu, China (215600)
P: 0512-5867-6496 F: 0512-5818-0970 C: 86

SUZHOU NSK BEARINGS CO., LTD.
OFFICE/PLANT No. 22 Taishan Road, Suzhou New District, Jiangsu, China (215129)
P: 0512-6665-5666 F: 0512-6665-9138 C: 86

NSK (CHINA) RESEARCH & DEVELOPMENT CO., LTD.
JIANGSU No.8 NSK Rd., Huaqiao Economic Development Zone, Kunshan, Jiangsu, China (215332)
P: 0512-5796-3000 F: 0512-5796-3300 C: 86

NSK (SHANGHAI) TRADING CO., LTD.
JIANGSU No.8 NSK Rd., Huaqiao Economic Development Zone, Kunshan, Jiangsu, China (215332)
P: 0512-5796-3000 F: 0512-5796-3300 C: 86

NSK (CHINA) INVESTMENT CO., LTD. www.nsk.com.cn
HEAD OFFICE No.8 NSK Rd., Huaqiao Economic Development Zone, Kunshan, Jiangsu, China (215332)
P: 0512-5796-3000 F: 0512-5796-3300 C: 86

BEIJING Room 2116, Beijing Fortune Bldg., 5 Dong San Huan Bei Lu, Chao Yang District, Beijing, China (100004)
P: 010-6590-8161 F: 010-6590-8166 C: 86

GUANGZHOU Room 3101/3102/3106A, Guangdong Telecom Plaza, 18 Zhongshan Er Road, Guangzhou, Guangdong, China (510080)
P: 020-3786-4833 F: 020-3786-4501 C: 86

CHENGDU Room1117, Lippo Tower, No.62 North Kehua Road, Chengdu, Sichuan, China (610041)
P: 028-8528-3680 F: 028-8528-3690 C: 86

SHENYANG Room 3805-3806, Tower A, Royal Wanxin International Mansion, No.390 Qingnian Street, Heping District, Shenyang, Liaoning, China (110003)
P: 024-2334-2868 F: 024-2334-2058 C: 86

DALIAN Room 1805 Xiwang Tower, No.136 Zhongshan Road, Zhongshan District, Dalian, Liaoning, China (116001)
P: 0411-8800-8168 F: 0411-8800-8160 C: 86

NSK CHINA SALES CO., LTD.
HEAD OFFICE No.8 NSK Rd., Huaqiao Economic Development Zone, Kunshan, Jiangsu, China (215332)
P: 0512-5796-3000 F: 0512-5796-3300 C: 86

CHANGCHUN Room 1001, Building A, Zhongyin Building, 727 Xi'an Road, Changchun, Jilin, China (130061)
P: 0431-8898-8682 F: 0431-8898-8670 C: 86

TIAN JIN Room 06, 09F The Exchange Tower 2, No. 189 NanJing Road, Heping District, Tianjin, China (300050)
P: 022-8319-5030 F: 022-8319-5033 C: 86

NANJING A1 22F, Golden Eagle International Plaza, No.89 Hanzhong Road, Nanjing, Jiangsu, China (210029)
P: 025-8472-6671 F: 025-8472-6687 C: 86

CHONGQING Room 2306, Unit B, No.137, Keyuan 2nd Road, Jiulongpo District, Chongqing, China (400039)
P: 023-6806-5310 F: 023-6806-5292 C: 86

NSK-WARNER (SHANGHAI) CO., LTD.
OFFICE/PLANT No. 2518 Huancheng Road (West) Fengxian District, Shanghai, China (201401)
P: 021-3365-5757 F: 021-3365-5262 C: 86

AKS PRECISION BALL (HANGZHOU) CO., LTD.
PLANT No. 189 Hongda Road, Xiaoshan Area of Economic & Technological Development Zone, Hangzhou, Zhejiang, China (311231)
P: 0571-2280-1288 F: 0571-2280-1268 C: 86

NSK-YAGI PRECISION FORGING (ZHANGJIAGANG) CO., LTD.
PLANT No. 34 Zhenxing Road, Zhangjiagang Economic Development Zone, Zhangjiagang City, Jiangsu, China (215600)
P: 0512-5867-6496 F: 0512-5818-0970 C: 86

NSK-WANDA ELECTRIC POWER ASSISTED STEERING SYSTEMS CO., LTD.
OFFICE/PLANT 1833 Yatai Road, Wenyuan Town, Xiaoshan, Hangzhou, Zhejiang, China (311258)
P: 0571-8231-4818 F: 0571-8248-6656 C: 86

SHENYANG NSK PRECISION CO., LTD.
OFFICE/PLANT No. 7 of 15 Street, Shenyang Economic & Technological Development Area, Shenyang, Liaoning, China (110141)
P: 024-2550-5017 F: 024-2532-6081 C: 86

India:
RANE NSK STEERING SYSTEMS LTD.
CHENNAI 14, Rajagopalan Salai, Vallancherry, Guduvancherry, Tamil Nadu-603 202, India
P: 044-474-06017 F: 044-274-66001 C: 91

BAWAL Plot No.28A, Sector 6, HSIDC Growth Centre Bawal, District Rewari, Haryana -123 501, India
P: 01284-264281 F: 01284-264280 C: 91

NSK INDIA SALES CO.PVT.LTD.
CHENNAI New No.7, Old No.5, Boat Club Road, Chennai-600 028, India
P: 044-2433-1161 F: 044-2433-1160 C: 91

GURGAON 107, Park Centra, Sector-30, Opposite 32nd Milestone, NH-8, Gurgaon, Haryana-122 001, India
P: 0124-4104-530 F: 0124-4104-532 C: 91

KOLKATA 502, Trinity Towers, 83, Topsia Road, Kolkata-700 046, India
P: 033-4001-2062 F: 033-4001-2064 C: 91

MUMBAI 321, A Wing, Ahura Centre, 82, Mahakali Caves Road, Andheri East, Mumbai -400 093, India
P: 022-2838-7787 F: 022-2838-5191 C: 91

NSK-ABC BEARINGS LTD.
OFFICE/PLANT Plot No.A2, SIPCOT Growth Centre, Oragadam, Mathur Village, Sriperumbudur Taluk, Kancheepuram District, Tamil Nadu-602 105, India
P: 044-2714-3000 F: 044-2714-3099 C: 91

Indonesia:
PT. NSK BEARINGS MANUFACTURING INDONESIA
JAKARTA PLANT Blok M4, Kawasan Berikat MM2100 Industrial Town Cikarang Barat, Bekasi 17520, Indonesia
P: 021-898-0155 F: 021-898-0156 C: 62

PT. NSK INDONESIA www.id.nsk.com
JAKARTA Summitmas II, 6th Floor, Jl. Jend Sudirman Kav. 61-62, Jakarta 12190, Indonesia
P: 021-252-3458 F: 021-252-3223 C: 62

PT. NSK-WARNER INDONESIA
BEKASI MM2100 Industrial Town, Cikarang Barat, Bekasi 17520, Indonesia
P: 021-8998-3216 F: 021-8998-3218 C: 62

Korea:
NSK KOREA CO., LTD. www.kr.nsk.com
SEOUL Posco Center (West Wing) 9F, 892, Daechi-4Dong, Kangnam-Ku, Seoul, 135-777, Korea
P: 02-3287-0300 F: 02-3287-0345 C: 82

CHANGWON 60, Seongsan-Dong, Changwon, Kyungsangnam-Do, 642-315, Korea
PLANT P: 055-287-6001 F: 055-285-9982 C: 82

Malaysia:
NSK BEARINGS (MALAYSIA) SDN. BHD. www.my.nsk.com
HEAD OFFICE No. 2, Jalan Pemaju, U1/15, Seksyen U1, Hicom Glenmarie Industrial Park, 40150 Shah Alam, Selangor, Malaysia
P: 03-7803-8859 F: 03-7806-5982 C: 60

PRAI No.36, Jalan kikiik, Taman Inderawasih, 13600 Prai, Penang, Malaysia
P: 04-3902275 F: 04-3991830 C: 60

JOHOR BAHRU 88 Jalan Ros Merah 2/17, Taman Johor Jaya, 81100 Johor Bahru, Johor, Malaysia
P: 07-3546290 F: 07-3546291 C: 60

KOTA KINABALU No. 8 Lot 3B, Block C, Lorong Waja 2, Taman Waja, Jalan Pintas, Kepayan Ridge, 88300 Kota Kinabalu, Sabah, Malaysia
P: 088-413798 F: 088-413798 C: 60

IPOH Gr. Floor, 89 Jalan Bendahara, 31650 Ipoh, Perak, Malaysia
P: 05-2555000 F: 05-2553373 C: 60

NSK MICRO PRECISION (M) SDN. BHD. www.my.nsk.com
MALAYSIA PLANT No.43 Jalan Taming Dua, Taman Taming Jaya 43300 Balakong, Selangor Darul Ehsan, Malaysia
P: 03-8961-3960 F: 03-8961-3968 C: 60

New Zealand:
NSK NEW ZEALAND LTD. www.nsk-rhp.co.nz
AUCKLAND 3 Te Apunga Place, Mt. Wellington, Auckland, New Zealand
P: 09-276-4992 F: 09-276-4082 C: 64

Philippines:
NSK REPRESENTATIVE OFFICE
MANILA 8th Floor The Salcedo Towers 169 H.V. dela Costa St., Salcedo Village Makati City, Philippines 1227
P: 02-893-9543 F: 02-893-9173 C: 63

Singapore:
NSK INTERNATIONAL (SINGAPORE) PTE LTD.
SINGAPORE 238A, Thomson Road, #24-01/05, Novena Square Tower A, Singapore 307684
P: 6496-8000 F: 6250-5845 C: 65

NSK SINGAPORE (PRIVATE) LTD. www.nsk-singapore.com.sg
SINGAPORE 238A, Thomson Road, #24-01/05, Novena Square Tower A, Singapore 307684
P: 6496-8000 F: 6250-5845 C: 65

Taiwan:
TAIWAN NSK PRECISION CO., LTD.
TAIPEI 11F., No.87, Song Jiang Rd., Zhongshan District, Taipei City 104, Taiwan R.O.C.
P: 02-2509-3305 F: 02-2509-1393 C: 886

TAICHUNG 107-7, Sec. 3, Wen Xing Rd., Taichung City 407, Taiwan R.O.C.
P: 04-2311-7978 F: 04-2311-2627 C: 886

TAINAN No.8 Daye 1st Rd., Southern Taiwan Science Park, Tainan County 741, Taiwan R.O.C.
P: 06-505-5861 F: 06-505-5061 C: 886

NSK Ltd. has a basic policy not to export any products or technology designated as controlled items by export-related laws. When exporting the products in this brochure, the laws of the exporting country must be observed. Specifications are subject to change without notice and without any obligation on the part of the manufacturer. Every care has been taken to ensure the accuracy of the data contained in this brochure, but no liability can be accepted for any loss or damage suffered through errors or omissions. We will gratefully acknowledge any additions or corrections.

Worldwide Sales Offices and Manufacturing Plants

P: Phone F: Fax C: Country Code Printed in Japan

TAIWAN NSK TECHNOLOGY CO., LTD.

TAIPEI 11F., No. 87, Songjiang Rd., Jhongshan District, Taipei City 104, Taiwan R.O.C.
P: 02-2509-3305 F: 02-2509-1393 C: 886

Thailand:

NSK BEARINGS (THAILAND) CO., LTD.

BANGKOK 26 Soi On-Nuch 55/1 Pravet District, Bangkok 10250, Thailand
P: 02320-2555 F: 02320-2826 C: 66

NSK BEARINGS MANUFACTURING (THAILAND) CO., LTD.

OFFICE/PLANT 700/430 Moo 7, Amata Nakorn Industrial Estate, T.Donhualor, A.Muangchonburi, Chonburi 20000, Thailand
P: 038-454-010 F: 038-454-017 C: 66

SIAM NSK STEERING SYSTEMS CO., LTD.

OFFICE/PLANT 90 Moo 9, Wellgrow Industrial Estate, Km.36 Bangna-Trad Rd., Bangwao, Bangkok, Chachoengsao 24180, Thailand
P: 038-522-343 F: 038-522-351 C: 66

NSK ASIA PACIFIC TECHNOLOGY CENTRE (THAILAND) CO., LTD.

CHONBURI 700/430 Moo 7, Amata Nakorn Industrial Estate, T.Donhualor, A.Muangchonburi, Chonburi 20000, Thailand
P: 038-454-631 F: 038-454-634 C: 66

Vietnam:

NSK VIETNAM CO., LTD.

HEAD OFFICE Techno Center, Room 204-205, Thang Long Industrial Park, Dong Anh District, Hanoi, Vietnam
P: 04-3955-0159 F: 04-3955-0158 C: 84

NSK REPRESENTATIVE OFFICE

HO CHI MINH CITY Suite 307, Metropolitan Building, 235 Dong Khoi Street, District 1, HCMC, Vietnam
P: 08-3822-7907 F: 08-3822-7910 C: 84

●Europe

NSK EUROPE LTD. (EUROPEAN HEADQUARTERS) www.eu.nsk.com

MAIDENHEAD Belmont Place, Belmont Road, Maidenhead, Berkshire SL6 6TB, U.K.
P: 01628-509-800 F: 01628-509-808 C: 44

France:

NSK FRANCE S.A.S.

PARIS Quartier de l'Europe, 2 Rue Georges Guynemer, 78283 Guyancourt, France
P: 01-30-57-39-39 F: 01-30-57-00-01 C: 33

Germany:

NSK DEUTSCHLAND GMBH

HEAD OFFICE Harkortstrasse 15, D-40880 Ratingen, Germany
P: 02102-4810 F: 02102-4812-290 C: 49

STUTT GART Liebknechtstrasse 33, D-70565 Stuttgart-Vaihingen, Germany
P: 0711-79082-0 F: 0711-79082-289 C: 49

WOLFSBURG Heinrich-Nordhoff-Strasse 101, D-38440 Wolfsburg, Germany
P: 05361-27647-10 F: 05361-27647-70 C: 49

NSK PRECISION EUROPE GMBH

DÜSELDORF Harkortstrasse 15, D-40880 Ratingen, Germany
P: 02102-4810 F: 02102-4812-290 C: 49

NEUWEG FERTIGUNG GMBH

OFFICE/PLANT Ehinger Strasse 5, D-89597 Munderkingen, Germany
P: 07393-540 F: 07393-5414 C: 49

Italy:

NSK ITALIA S.P.A.

MILANO Via Garibaldi 215, Garbagnate Milanese (Milano) 20024, Italy
P: 0299-5191 F: 0299-025778 C: 39

Netherlands:

NSK EUROPEAN DISTRIBUTION CENTRE B.V.

De Kroonstraat 38, 5048 AP Tilburg, Netherlands
P: 013-4647647 F: 013-4647648 C: 31

Poland:

NSK EUROPE LTD. REPRESENTATIVE OFFICE

WARSAW Ul. Migdalowa 4/73, 02-796, Warsaw, Poland
P: 022-645-1525 F: 022-645-1529 C: 48

NSK BEARINGS POLSKA S.A.

OFFICE/PLANT Ul. Jagiellonska 109, 25-734 Kielce, Poland
P: 041-366-5001 F: 041-367-0500 C: 48

NSK EUROPEAN TECHNOLOGY CENTER, POLAND OFFICE

Ul. Jagiellonska 109, 25-734 Kielce, Poland
P: 041-367-0940 F: 041-367-0930 C: 48

NSK STEERING SYSTEMS EUROPE (POLSKA) SP.ZO.O.

CORPORATE Ul. Mariana Jachimowicza 17, 58-306 Walbrzych, Poland
OFFICE/PLANT P: 074-664-4101 F: 074-664-4104 C: 48

NSK NEEDLE BEARING POLAND SP.ZO.O.

OFFICE/PLANT Ul. Jagiellonska 109, 25-734 Kielce, Poland
P: 041-345-2469 F: 041-345-0361 C: 48

NSK POLSKA SP.ZO.O.

KIELCE Ul. Karczowkowska 41, 25-711 Kielce, Poland
P: 041-347-5110 F: 041-347-5101 C: 48

Spain:

NSK SPAIN S.A.

BARCELONA C/Tarragona 161, 2a Planta, 08014, Barcelona, Spain
P: 093-433-5775 F: 093-433-5776 C: 34

Turkey:

NSK RULMANLARI ORTA DOGU TIC. LTD. STI.

ISTANBUL 19 Mayıs Mah. Atatürk Cad. Ulya Engin Is Merkezi No. 68 Kat. 6, Kozyatagi 34734, Istanbul, Turkey
P: 0216-355-0398 F: 0216-355-0399 C: 90

United Kingdom:

NSK BEARINGS EUROPE LTD.

PETERLEE 3 Brindley Road, South West Industrial Estate, Peterlee, Co. Durham SR8 2JD, U.K.
PLANT P: 0191-586-6111 F: 0191-586-3482 C: 44

NEWARK Northern Road, Newark, Nottinghamshire NG24 2JF, U.K.

PLANT P: 01636-605-123 F: 01636-605-000 C: 44

NSK EUROPEAN TECHNOLOGY CENTRE

NEWARK Northern Road, Newark, Nottinghamshire NG24 2JF, U.K.
P: 01636-605-123 F: 01636-643-241 C: 44

NSK UK LTD.

NEWARK Northern Road, Newark, Nottinghamshire NG24 2JF, U.K.
P: 01636-605-123 F: 01636-605-000 C: 44

NSK PRECISION UK LTD.

PLANT Northern Road, Newark, Nottinghamshire NG24 2JF, U.K.
P: 01636-605-123 F: 01636-605-000 C: 44

NSK STEERING SYSTEMS EUROPE LTD.

HEAD OFFICE Belmont Place, Belmont Road, Maidenhead, Berkshire SL6 6TB, U.K.
P: 01628-509-800 F: 01628-509-808 C: 44

PETERLEE 6/7 Doxford Drive, South West Industrial Estate, Peterlee, Co. Durham SR8 2PP, U.K.

PLANT P: 0191-518-6400 F: 0191-518-6421 C: 44

●North and South America

NSK AMERICAS, INC. (AMERICAN HEADQUARTERS)

ANN ARBOR 4200 Goss Road, Ann Arbor, Michigan 48105, U.S.A.
P: 734-913-7500 F: 734-913-7511 C: 1

Argentina:

NSK ARGENTINA SRL

BUENOS AIRES Garcia del Rio 2477 Piso 7 Oficina "A" (1429) Buenos Aires-Argentina
P: 11-4704-5100 F: 11-4704-0033 C: 54

Brazil:

NSK BRASIL LTDA. www.br.nsk.com

HEAD OFFICE Rua 13 de Maio, 1633-14th Andar-Bela Vista-CEP 01327-905 São Paulo, SP, Brazil
P: 011-3269-4786 F: 011-3269-4720 C: 55

SUZANO PLANT Av. Vereador Joao Batista Fitipaldi, 66, CEP 08685-000, Vila Maluf, Suzano, SP, Brazil
P: 011-4744-2527 F: 011-4744-2529 C: 55

BELO HORIZONTE Rua Ceara 1431-4th andar-sala 405-Funcionarios Belo Horizonte-MG, Brazil
30150-311

P: 031-3274-2591 F: 031-3273-4408 C: 55

JOINVILLE Rua Blumenau, 178-sala 910-Centro Joinville-SC, Brazil 89204-250

P: 047-3422-5445 F: 047-3422-2817 C: 55

PORTO ALEGRE Av. Cristovão Colombo, 1694-sala 202-Floresta Porto Alegre-RS, Brazil 90560 001

P: 051-3222-1324 F: 051-3222-2599 C: 55

RECIFE Av. Conselheiro Aguiar, 2738-8th andar-conj. 604-Boa Viagem Recife-PE, Brazil 51020-020
P: 081-3326-3781 F: 081-3326-5047 C: 55

Peru:

NSK PERU S.A.C.

LIMA Av. Caminos del Inca 670, Ofic : # 402, Santiago del Surco, Lima, Perú
P: 01-652-3372 F: 01-638-0555 C: 51

Canada:

NSK CANADA INC. www.ca.nsk.com

HEAD OFFICE 5585 McAdam Road, Mississauga, Ontario, Canada L4Z 1N4

P: 905-890-0740 F: 800-800-2788 C: 1

TORONTO 5585 McAdam Road, Mississauga, Ontario, Canada L4Z 1N4

P: 877-994-6675 F: 800-800-2788 C: 1

MONTREAL 2150-32E Avenue Lachine, Quebec, Canada H8T 3H7

P: 514-633-1220 F: 800-800-2788 C: 1

VANCOUVER 3353 Wayburne Drive, Burnaby, British Columbia, Canada V5G 4L4

P: 877-994-6675 F: 800-800-2788 C: 1

Mexico:

NSK RODAMIENTOS MEXICANA, S.A. DE C.V. www.mx.nsk.com

MEXICO CITY Av. Presidente Juarez No.2007 Lote 5, Col. San Jeronimo Tepetlalcaltco, Tlalnepan, Estado de Mexico, Mexico, C.P.54090

P: 55-3682-2900 F: 55-3682-2937 C: 52

MONTERREY Av. Ricardo Margain 575, Torre C, IOS Campestre, San Pedro Garcia, Nuevo Leon, Mexico, C.P.66267

P: 81-8000-7300 F: 81-8000-7095 C: 52

United States of America:

NSK CORPORATION www.us.nsk.com

HEAD OFFICE 4200 Goss Road, Ann Arbor, Michigan 48105, U.S.A.
P: 734-913-7500 F: 734-913-7511 C: 1

NSK AMERICAN 4200 Goss Road, Ann Arbor, Michigan 48105, U.S.A.

TECHNOLOGY CENTER P: 734-913-7500 F: 734-913-7511 C: 1

CLARINDA PLANT 1100 N. First Street, Clarinda, Iowa 51632, U.S.A.

P: 712-542-5121 F: 712-542-4905 C: 1

FRANKLIN PLANT 3400 Bearing Drive, Franklin, Indiana 46131, U.S.A.

P: 317-738-5000 F: 317-738-5064 C: 1

LIBERTY PLANT 1112 East Kitchel Road, Liberty, Indiana 47353, U.S.A.

P: 765-458-5000 F: 765-458-7832 C: 1

NSK PRECISION AMERICA, INC. www.npa.nsk.com

OFFICE/PLANT 3450 Bearing Drive, Franklin, Indiana 46131, U.S.A.
P: 317-738-5000 F: 317-738-5050 C: 1

SAN JOSE 780 Montague Expressway, Suite 508, San Jose, California 95131, U.S.A.

P: 408-944-9400 F: 408-944-9405 C: 1

NSK STEERING SYSTEMS AMERICA, INC. www.nssa.nsk.com

OFFICE/PLANT 110 Shields Drive, Bennington, Vermont 05201, U.S.A.
P: 802-442-5448 F: 802-442-2253 C: 1

DYERSBURG PLANT 2962 Fort Hudson Road, Dyersburg, TN 38204, U.S.A.

P: 731-288-3000 F: 731-288-3001 C: 1

ANN ARBOR 4200 Goss Road, Ann Arbor, Michigan 48105, U.S.A.

P: 734-913-7500 F: 734-913-7102 C: 1

NSK-WARNER U.S.A., INC.

TROY 3001 West Big Beaver Road, Suite 701, Troy, Michigan 48084, U.S.A.
P: 248-822-8888 F: 248-822-1111 C: 1

NSK LATIN AMERICA, INC. www.la.nsk.com

MIAMI 2500 NW 107th Avenue, Suite 300, Miami, Florida 33172, U.S.A.
P: 305-477-0605 F: 305-477-0377 C: 1

<As of February 2011>

For the latest information, please refer to the NSK website.

NSK Ltd. has a basic policy not to export any products or technology designated as controlled items by export-related laws. When exporting the products in this brochure, the laws of the exporting country must be observed. Specifications are subject to change without notice and without any obligation on the part of the manufacturer. Every care has been taken to ensure the accuracy of the data contained in this brochure, but no liability can be accepted for any loss or damage suffered through errors or omissions. We will gratefully acknowledge any additions or corrections.



NSK used environmentally friendly paper and printing methods for this publication.

CAT. No.E1254f 2011 D-2 Printed in Japan ©NSK Ltd. 2003